

MOTIF-RACK XS



OWNER'S MANUAL

TONE GENERATOR

MOTIF-RACK XS

SPECIAL MESSAGE SECTION

This product utilizes batteries or an external power supply (adapter). DO NOT connect this product to any power supply or adapter other than one described in the manual, on the name plate, or specifically recommended by Yamaha.

WARNING: Do not place this product in a position where anyone could walk on, trip over, or roll anything over power or connecting cords of any kind. The use of an extension cord is not recommended! If you must use an extension cord, the minimum wire size for a 25' cord (or less) is 18 AWG. NOTE: The smaller the AWG number, the larger the current handling capacity. For longer extension cords, consult a local electrician.

This product should be used only with the components supplied or; a cart, rack, or stand that is recommended by Yamaha. If a cart, etc., is used, please observe all safety markings and instructions that accompany the accessory product.

SPECIFICATIONS SUBJECT TO CHANGE:

The information contained in this manual is believed to be correct at the time of printing. However, Yamaha reserves the right to change or modify any of the specifications without notice or obligation to update existing units.

This product, either alone or in combination with an amplifier and headphones or speaker/s, may be capable of producing sound levels that could cause permanent hearing loss. DO NOT operate for long periods of time at a high volume level or at a level that is uncomfortable. If you experience any hearing loss or ringing in the ears, you should consult an audiologist.

IMPORTANT: The louder the sound, the shorter the time period before damage occurs.

Some Yamaha products may have benches and / or accessory mounting fixtures that are either supplied with the product or as optional accessories. Some of these items are designed to be dealer assembled or installed. Please make sure that benches are stable and any optional fixtures (where applicable) are well secured BEFORE using.

Benches supplied by Yamaha are designed for seating only. No other uses are recommended.

NOTICE:

Service charges incurred due to a lack of knowledge relating to how a function or effect works (when the unit is operating as designed) are not covered by the manufacturer's warranty, and are therefore the owners responsibility. Please study this manual carefully and consult your dealer before requesting service.

ENVIRONMENTAL ISSUES:

Yamaha strives to produce products that are both user safe and environmentally friendly. We sincerely believe that our products and the production methods used to produce them, meet these goals. In keeping with both the letter and the spirit of the law, we want you to be aware of the following:

Battery Notice:

This product MAY contain a small non-rechargeable battery which (if applicable) is soldered in place. The average life span of this type of battery is approximately five years. When replacement becomes necessary, contact a qualified service representative to perform the replacement.

This product may also use "household" type batteries. Some of these may be rechargeable. Make sure that the battery being charged is a rechargeable type and that the charger is intended for the battery being charged.

When installing batteries, do not mix batteries with new, or with batteries of a different type. Batteries MUST be installed correctly. Mismatches or incorrect installation may result in overheating and battery case rupture.

Warning:

Do not attempt to disassemble, or incinerate any battery. Keep all batteries away from children. Dispose of used batteries promptly and as regulated by the laws in your area. Note: Check with any retailer of household type batteries in your area for battery disposal information.

Disposal Notice:

Should this product become damaged beyond repair, or for some reason its useful life is considered to be at an end, please observe all local, state, and federal regulations that relate to the disposal of products that contain lead, batteries, plastics, etc. If your dealer is unable to assist you, please contact Yamaha directly.

NAME PLATE LOCATION:

The name plate is located on the top panel of the product. The name plate lists the product's model number, power requirements, and other information. The serial number is located on the rear panel. Please record the model number, serial number, and date of purchase in the spaces provided below, and keep this manual as a permanent record of your purchase.

Model _____

Serial No. _____

Purchase Date _____

PLEASE KEEP THIS MANUAL

92-BP (others)

FCC INFORMATION (U.S.A.)

1. IMPORTANT NOTICE: DO NOT MODIFY THIS UNIT!

This product, when installed as indicated in the instructions contained in this manual, meets FCC requirements. Modifications not expressly approved by Yamaha may void your authority, granted by the FCC, to use the product.

2. IMPORTANT:

When connecting this product to accessories and/or another product use only high quality shielded cables. Cable/s supplied with this product MUST be used. Follow all installation instructions. Failure to follow instructions could void your FCC authorization to use this product in the USA.

3. NOTE:

This product has been tested and found to comply with the requirements listed in FCC Regulations, Part 15 for Class "B" digital devices. Compliance with these requirements provides a reasonable level of assurance that your use of this product in a residential environment will not result in harmful interference with other electronic devices. This equipment generates/uses radio frequencies and, if not installed and used according to the instructions found in the users manual, may cause interference harmful to the operation of other electronic devices. Compliance with FCC regulations does

not guarantee that interference will not occur in all installations. If this product is found to be the source of interference, which can be determined by turning the unit "OFF" and "ON", please try to eliminate the problem by using one of the following measures:

Relocate either this product or the device that is being affected by the interference.

Utilize power outlets that are on different branch (circuit breaker or fuse) circuits or install AC line filter/s.

In the case of radio or TV interference, relocate/reorient the antenna. If the antenna lead-in is 300 ohm ribbon lead, change the lead-in to co-axial type cable.

If these corrective measures do not produce satisfactory results, please contact the local retailer authorized to distribute this type of product. If you can not locate the appropriate retailer, please contact Yamaha Corporation of America, Electronic Service Division, 6600 Orangethorpe Ave, Buena Park, CA90620

The above statements apply ONLY to those products distributed by Yamaha Corporation of America or its subsidiaries.

* This applies only to products distributed by YAMAHA CORPORATION OF AMERICA.

(class B)

COMPLIANCE INFORMATION STATEMENT (DECLARATION OF CONFORMITY PROCEDURE)

Responsible Party : Yamaha Corporation of America
Address : 6600 Orangethorpe Ave., Buena Park, Calif. 90620
Telephone : 714-522-9011
Type of Equipment : TONE GENERATOR
Model Name : MOTIF-RACK XS

This device complies with Part 15 of the FCC Rules.

Operation is subject to the following two conditions:

- 1) this device may not cause harmful interference, and
- 2) this device must accept any interference received including interference that may cause undesired operation.

See user manual instructions if interference to radio reception is suspected.

* This applies only to products distributed by
YAMAHA CORPORATION OF AMERICA.

(FCC DoC)

IMPORTANT NOTICE FOR THE UNITED KINGDOM Connecting the Plug and Cord

IMPORTANT. The wires in this mains lead are coloured in accordance with the following code:

BLUE : NEUTRAL
BROWN : LIVE

As the colours of the wires in the mains lead of this apparatus may not correspond with the coloured markings identifying the terminals in your plug proceed as follows:

The wire which is coloured BLUE must be connected to the terminal which is marked with the letter N or coloured BLACK.

The wire which is coloured BROWN must be connected to the terminal which is marked with the letter L or coloured RED.

Making sure that neither core is connected to the earth terminal of the three pin plug.

* This applies only to products distributed by Yamaha Music U.K. Ltd.

(2 wires)

OBSERVERA!

Apparaten kopplas inte ur växelströmskällan (nätet) så länge som den är ansluten till vägguttaget, även om själva apparaten har stängts av.

ADVARSEL: Netspændingen til dette apparat er IKKE afbrudt, så længe netledningen sidder i en stikkontakt, som er tændt — også selvom der er slukket på apparatets afbryder.

VAROITUS: Laitteen toisiopiiriin kytketty käyttökytin ei irroita koko laitetta verkosta.

(standby)

PRECAUTIONS

PLEASE READ CAREFULLY BEFORE PROCEEDING

* Please keep this manual in a safe place for future reference.



WARNING

Always follow the basic precautions listed below to avoid the possibility of serious injury or even death from electrical shock, short-circuiting, damages, fire or other hazards. These precautions include, but are not limited to, the following:

Power supply/AC power adaptor

- Only use the voltage specified as correct for the instrument. The required voltage is printed on the name plate of the instrument.
- Use the specified adaptor (PA-301, PA-300B, or an equivalent recommended by Yamaha) only. Using the wrong adaptor can result in damage to the instrument or overheating.
- Check the electric plug periodically and remove any dirt or dust which may have accumulated on it.
- Do not place the AC adaptor cord near heat sources such as heaters or radiators, and do not excessively bend or otherwise damage the cord, place heavy objects on it, or place it in a position where anyone could walk on, trip over, or roll anything over it.

Do not open

- Do not open the instrument or attempt to disassemble the internal parts or modify them in any way. The instrument contains no user-serviceable parts. If it should appear to be malfunctioning, discontinue use immediately and have it inspected by qualified Yamaha service personnel.

Water warning

- Do not expose the instrument to rain, use it near water or in damp or wet conditions, or place containers on it containing liquids which might spill into any openings. If any liquid such as water seeps into the instrument, turn off the power immediately and unplug the power cord from the AC outlet. Then have the instrument inspected by qualified Yamaha service personnel.
- Never insert or remove an electric plug with wet hands.

Fire warning

- Do not put burning items, such as candles, on the unit. A burning item may fall over and cause a fire.

If you notice any abnormality

- If the AC adaptor cord or plug becomes frayed or damaged, or if there is a sudden loss of sound during use of the instrument, or if any unusual smells or smoke should appear to be caused by it, immediately turn off the power switch, disconnect the adaptor plug from the outlet, and have the instrument inspected by qualified Yamaha service personnel.



CAUTION

Always follow the basic precautions listed below to avoid the possibility of physical injury to you or others, or damage to the instrument or other property. These precautions include, but are not limited to, the following:

Power supply/AC power adaptor

- When removing the electric plug from the instrument or an outlet, always hold the plug itself and not the cord.
- Unplug the AC power adaptor when not using the instrument, or during electrical storms.
- Do not connect the instrument to an electrical outlet using a multiple-connector. Doing so can result in lower sound quality, or possibly cause overheating in the outlet.

Location

- Do not expose the instrument to excessive dust or vibrations, or extreme cold or heat (such as in direct sunlight, near a heater, or in a car during the day) to prevent the possibility of panel disfiguration or damage to the internal components.
- Do not use the instrument in the vicinity of a TV, radio, stereo equipment, mobile phone, or other electric devices. Otherwise, the instrument, TV, or radio may generate noise.

- Do not place the instrument in an unstable position where it might accidentally fall over.
- Before moving the instrument, remove all connected adaptor and other cables.
- When setting up the product, make sure that the AC outlet you are using is easily accessible. If some trouble or malfunction occurs, immediately turn off the power switch and disconnect the plug from the outlet. Even when the power switch is turned off, electricity is still flowing to the product at the minimum level. When you are not using the product for a long time, make sure to unplug the power cord from the wall AC outlet.
- Use only the rack specified for the instrument. When attaching the stand or rack, use the provided screws only. Failure to do so could cause damage to the internal components or result in the instrument falling over.

Connections

- Before connecting the instrument to other electronic components, turn off the power for all components. Before turning the power on or off for all components, set all volume levels to minimum. Also, be sure to set the volumes of all components at their minimum levels and gradually raise the volume controls while playing the instrument to set the desired listening level.

Maintenance

- When cleaning the instrument, use a soft, dry cloth. Do not use paint thinners, solvents, cleaning fluids, or chemical-impregnated wiping cloths.

Handling caution

- Do not insert a finger or hand in any gaps on the instrument.
- Never insert or drop paper, metallic, or other objects into the gaps on the panel. If this happens, turn off the power immediately and unplug the power cord from the AC outlet. Then have the instrument inspected by qualified Yamaha service personnel.
- Do not place vinyl, plastic or rubber objects on the instrument, since this might discolor the panel or keyboard.
- Do not rest your weight on, or place heavy objects on the instrument, and do not use excessive force on the buttons, switches or connectors.
- Do not use the instrument/device or headphones for a long period of time at a high or uncomfortable volume level, since this can cause permanent hearing loss. If you experience any hearing loss or ringing in the ears, consult a physician.

Saving data

Saving and backing up your data

For instruments with DRAM (RAM that does not retain data)

- DRAM data (see page 48) is lost when you turn off the power to the instrument. Save the data to the flash ROM (see page 48)/ external device such as a computer.
Saved data to the flash ROM may be lost due to malfunction or incorrect operation. Save important data to external device such as a computer.
- Never attempt to turn off the power while data is being written to Flash ROM (while an "Executing..." or "Please keep power on" message is shown). Turning the power off in this state results in loss of all user data and may cause the system to freeze (due to corruption of data in the Flash ROM). This means that this tone generator may not be able to start up properly, even when turning the power on next time.

Backing up the external media

- To protect against data loss through media damage, we recommend that you save your important data onto two external media.

Yamaha cannot be held responsible for damage caused by improper use or modifications to the instrument, or data that is lost or destroyed.

Always turn the power off when the instrument is not in use.

Even when the power switch is in the "STANDBY" position, electricity is still flowing to the instrument at the minimum level. When you are not using the instrument for a long time, make sure you unplug the AC power adaptor from the wall AC outlet.

About the latest Firmware Version

Yamaha may from time to time update firmware of the product and the accessory application software without notice for improvement. We recommend that you check our web site for later releases and upgrade your firmware of the MOTIF-RACK XS or the accessory application software.

<http://www.yamahasyth.com/>

Note that the explanations in this Owner's Manual apply to the version of firmware when this Owner's Manual was produced. For details about the additional functions due to later releases, refer to the above website.

Introduction

Thank you for purchasing the Yamaha MOTIF-RACK XS Tone Generator. In order to get the best use out of your new MOTIF-RACK XS and fully take advantage of its many sophisticated features and functions, we urge you to read the manual carefully, and keep it in a safe, readily accessible location for future reference.

Accessories

- AC Power Adaptor (PA-301, PA-300B or an equivalent)*
- Owner's manual (this book)
- Data List
- Disk x 1 (containing DAW software)

* May not be included in your area. Please check with your Yamaha dealer.

About the Accessory Disk

SPECIAL NOTICE

- The software included in the accessory disk and the copyrights thereof are under exclusive ownership by Steinberg Media Technologies GmbH.
- Use of the software and this manual is governed by the license agreement which the purchaser fully agrees to upon breaking the seal of the software packaging. (Please read carefully the Software Licensing Agreement at the end of this manual before installing the application.)
- Copying of the software or reproduction of this manual in whole or in part by any means is expressly forbidden without the written consent of the manufacturer.
- Yamaha makes no representations or warranties with regard to the use of the software and documentation and cannot be held responsible for the results of the use of this manual and the software.
- This disk is NOT for audio/visual purpose. Do not attempt to play the disk on an audio/visual CD/DVD player. Doing so may result in irreparable damage to your player.
- Note that Yamaha does not offer technical support for the DAW software in the accessory disk.

About the DAW software in the accessory disk

The accessory disk contains DAW software both for Windows and Macintosh.

NOTE • Make sure to install DAW software under the "Administrator" account.

- In order to have continuous use of the DAW software in the accessory disk, including support and other benefits, you will need to register the software and activate your software license by starting it while the computer is connected to the Internet. Click the "Register Now" button shown when the software is started, then fill in all required fields for registration. If you do not register the software, you will be unable to use it after a limited period of time expires.
- If you are using a Macintosh computer, double-click the "****.pkg" file to start installation.

For information about the minimum system requirements and latest information on the software in the disk, check the web site below.

<<http://www.yamahasynth.com/>>

About software support

Support for the DAW software in the accessory disk is provided by Steinberg on its website at the following address.

<http://www.steinberg.net>

You can visit the Steinberg site also via the Help menu of the included DAW software. (The Help menu also includes the PDF manual and other information on the software.)

Main Features

■ Wide range of dynamic and authentic Voices—in a 1U rack-mounted tone generator

- Wide range of dynamic and authentic Voices of the original top-of-the-line Yamaha MOTIF XS Synthesizer—to give you whatever sound you need, for any musical style.
- Comprehensive effect processing, including Insertion Effects for up to eight Parts, independent three-band Part Equalizers for each Part, high-quality Reverb Effects and VCM Effects, provides pro-level sound enhancement for your music creation and performance.

■ Simple, intuitive panel layout

A detailed 160x64 dot graphic display provides comprehensive and easy-to-understand control over virtually all operations. Use the various buttons and the Encoder Knob to quickly and easily edit any of the parameters.

■ Large selection of versatile, instantly selectable multiple Voice setups—Multi Mode (page 35)

The MOTIF-RACK XS also features 128 different Multis, each specially programmed with its own effect, equalizer and other settings, and each designed particularly for a specific style of music or application—letting you quickly and easily call up the settings you need.

■ Powerful Arpeggio feature with four different types (page 40)

Arpeggio automatically plays a variety of sequenced phrases in response to the keys you play. This function is especially powerful with Drum Voices—letting you easily call up various rhythm patterns at the touch of a key, and providing instant inspiration for your performance. With Normal Voices, Arpeggio changes harmonically according to the chords you play, helping you as you compose or perform. Up to four Arpeggios can be running simultaneously, and of course, in perfect sync. Accent feature and Random SFX feature give you even greater expressive, realtime control over Arpeggio playback.

■ Five Knobs (page 29)

Comprehensive control with five knobs lets you adjust parameter values in real time, including the Effect settings applied to the Voice and Multi, allowing you to change the sound dynamically as you perform or record.

■ Wide variety of input/output terminals (page 12)

Equipped with an extensive set of terminals, including ASSIGNABLE OUTPUT jacks, DIGITAL OUT terminal, MIDI terminals, mLAN terminals (when the optional mLAN16E2 is installed) and USB terminals.

■ Quick Setup for using a computer (page 101)

This function lets you instantly reconfigure the MOTIF-RACK XS for different computer/sequencer related applications by calling up specially programmed presets.

■ Editor software for the MOTIF-RACK XS (page 23)

The instrument is also compatible with the MOTIF-RACK XS Editor—a comprehensive, easy-to-use editing software program that lets you edit (via USB connection) the Voices of the MOTIF-RACK XS, including the Element/Key parameters, Multis used for sequencer playback and Quick Setup parameters for use with a computer. The MOTIF-RACK XS Editor is free and can be downloaded from the Yamaha website.

■ Integration with Cubase (page 24)

The MOTIF-RACK XS is specially designed to work seamlessly with Cubase, Steinberg's full-featured DAW software—giving you a comprehensive, all-in-one music production system, in which hardware and software are fully integrated.

How to Use the Manual

The documentation for MOTIF-RACK XS consists of the following booklets.

■ Owner's Manual (this book)

The Controls & Connectors (page 10)

This section lists and explains the panel controls (such as LCD and buttons) and the connectors of the rear panel.

Setting Up (page 13)

This section covers how to set up this instrument before turning the power on.

Listening to the Sound (page 15)

This section shows you how to play the Demo Songs and Audition Phrases. We recommend you take time and listen to these, to hear the high-quality sounds of the MOTIF-RACK XS and its enormous capabilities.

Connections (page 17)

This section shows how to connect the MOTIF-RACK XS to various external devices.

Using a Computer (page 22)

This section shows you how to use the instrument with software programs such as Cubase and the MOTIF-RACK XS Editor.

Quick Guide (page 25)

This section explains the basic functions of the MOTIF-RACK XS and shows you how to get started using it as quickly as possible.

Basic Structure (page 49)

This section provides a detailed overview of all of the main functions and features of this instrument, and shows how they fit together.

Reference (page 64)

This section explains the parameters in the various modes of the MOTIF-RACK XS and MOTIF-RACK XS Editor.

Appendix (page 104)

This section contains detailed information about this instrument, including Display Messages, instructions for Installing the optional mLAN16E2, Troubleshooting, and Specifications.

■ Data List (separate booklet)

This contains various important lists such as the Voice List, Waveform List, Multi List, MIDI Data Format, etc.

■ Arpeggio Type List (separate online documentation)

This contains the Arpeggio Type List. This special online documentation can be downloaded from the Manual Library site. For details about how to use this List, see page 54.

<http://www.yamaha.co.jp/manual/>

Various pages and menus appear on the LCD of this instrument depending the selected mode or function. Throughout this manual, arrows are used in the instructions, indicating in shorthand the process of calling up certain displays and functions. For example, the instructions below indicate to: 1) press the [VOICE] button, 2) select a Normal Voice, 3) press the [EDIT] button, 4) Select "Name" in the Voice Edit Select display, 5) press the [ENTER] button.

[VOICE] → select Normal Voice → [EDIT] → select "Name" in the Voice Edit Select display → [ENTER]

NOTE When a confirmation message (page 104) is shown in the display, press the [EXIT] button to exit from that condition, then execute the instructions as in the above example.

SPECIAL NOTICE

- The contents of this Owner's Manual and the copyrights thereof are under exclusive ownership by Amah Corporation.
- The illustrations and LCD screens as shown in this owner's manual are for instructional purposes only, and may appear somewhat different from those on your instrument.
- This product incorporates and bundles computer programs and contents in which Amah owns copyrights or with respect to which it has license to use others' copyrights. Such copyrighted materials include, without limitation, all computer software, style files, MIDI files, WAVE data, musical scores and sound recordings. Any unauthorized use of such programs and contents outside of personal use is not permitted under relevant laws. Any violation of copyright has legal consequences. **DON'T MAKE, DISTRIBUTE OR USE ILLEGAL COPIES.**
- This device is capable of using various types/formats of music data by optimizing them to the proper format music data for use with the device in advance. As a result, this device may not play them back precisely as their producers or composers originally intended.
- Copying of the commercially available musical data including but not limited to MIDI data and/or audio data is strictly prohibited except you're your personal use.
- Windows is the registered trademark of Microsoft® Corporation.
- Apple and Macintosh are trademarks of Apple Inc., registered in the U.S. and other countries.
- Steinberg and Cubase are the registered trademarks of Steinberg Media Technologies GmbH.
- The company names and product names in this Owner's Manual are the trademarks or registered trademarks of their respective companies.

Contents

Introduction	6	Using the Arpeggio Function	40
Accessories	6	What is the Arpeggio function?	40
About the Accessory Disk.....	6	Arpeggio playback.....	41
Main Features	7	Controlling from an External MIDI Keyboard.....	44
How to Use the Manual.....	8	External controllers supported by the MOTIF-RACK XS.....	44
		Assigning Control numbers	45
The Control & Connectors	10	Storing the Edited Voice, Multi and Utility Settings	46
Front Panel	10	Storing the edited Voice, Multi and Utility settings in the internal	
Rear Panel.....	12	Flash ROM	46
		Saving data to an external device (Bulk Dump)	47
Setting Up	13	Resetting the User Memory to the Initial Factory	48
Power Supply	13	Settings	48
Cable Clip.....	13		
Using Headphones or Speakers	13	Basic Structure	49
Power-on Procedure	14	The Five Functional Blocks.....	49
Turning the Power On/Off	14	Tone Generator Block.....	50
		Tone Generator block in the Voice mode.....	50
Listening to the Sound	15	Tone Generator block in the Multi mode	52
Demo Playback	15	Audio Input Block.....	53
Audition Phrase Playback	16	Arpeggio Block.....	53
		Arpeggio Category	53
Connections	17	Arpeggio Sub Category	53
Connecting to a Computer and MIDI Device	17	Arpeggio Type Name	54
Connecting to External MIDI Equipment.....	21	How to use the Arpeggio Type List	54
		Arpeggio related settings.....	54
Using a Computer	22	Arpeggio playback types	55
Creating a Song by Using a Computer	22	Controller Block	57
Song playback from a computer using the MOTIF-RACK XS		Effect Block	57
sounds	22	Effect structure	57
Using another synthesizer together with the MOTIF-RACK XS	22	Effect connection in each mode	58
Using the MOTIF-RACK XS Editor	23	Effect Types divided into Effect Categories.....	59
Integration Between the MOTIF-RACK XS and		Effect Parameters.....	61
Cubase	24	Reference	64
What you can do by using Cubase 4/ Cubase AI 4 together with		Voice Mode	64
the MOTIF-RACK XS	24	Normal Voice Edit.....	64
Studio Connections	24	Element Edit	73
		Drum Voice Edit	83
Quick Guide	25	Supplementary information	87
Modes of MOTIF-RACK XS and Basic Operation..	25	Multi Mode.....	91
Voice Mode	25	Multi Edit.....	91
Multi Mode	25	Utility	98
The modes of the MOTIF-RACK XS.....	26		
How to leave the current display	26	Appendix	104
Voice Mode	27	Display Messages	104
Playing the Voices	27	About MIDI	105
Using Knobs 1 – 5 to change the sound	29	Installing the Optional mLAN16E2.....	108
Voice Editing	31	Troubleshooting.....	109
Using Voice Effects.....	33	Specifications	112
Multi Mode	35	SOFTWARE LICENSE AGREEMENT	113
Playing a Multi.....	35	Index	114
Editing the Multi	36		
Effect settings in the Multi mode	38		
Playing four Parts in a layer with a single MIDI keyboard.....	40		

The Control & Connectors

Front Panel

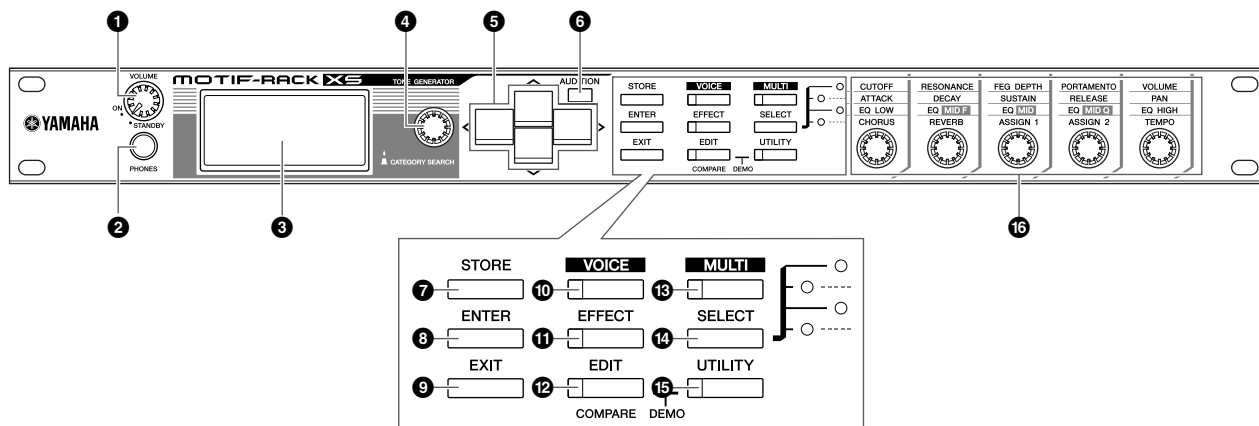

1 VOLUME knob

This knob has two functions. It switches the power on and off (STANDBY), and has a click detent to provide tactile indication of turning the power on/off. When the power is turned on, the knob also enables you to adjust the overall volume of the instrument. Turning this knob right raises the volume or level output from the OUTPUT L/R jack and PHONE jack.

2 PHONES jack (page 13)

This standard stereo phones jack is for connection to a set of stereo headphones.

3 LCD (Liquid Crystal Display)

The MOTIF-RACK XS's backlit LCD displays the parameters and values related to the currently selected operation or mode.

4 Encoder knob

For editing (changing the value of) the currently selected parameter. To increase the value, turn the dial right (clockwise); to decrease the value, turn the dial left (counterclockwise). If a parameter with a wide value range is selected, you can change the value in broader strokes by quickly turning this knob. Turning the knob can move the cursor leftward, rightward, upward and downward only when the selection menu (each of which is surrounded by the box) is shown on the display for each mode.

Note that this knob can be pressed as well as turned. On the Voice select display and Multi select display, the Category Search dialogue can be called up by pressing this knob. For other displays, pressing this knob is equivalent to pressing the [ENTER] button.

5 Cursor [^]/[v]/[<]/[>] buttons

The cursor buttons move the "cursor" around the LCD screen, highlighting and selecting the various parameters. On the Voice select display and Multi select display, pressing the Cursor [^]/[v] button increases or decreases the Voice number or Multi number by 1 while pressing the Cursor [<]/[>] button calls up the adjacent Voice Bank or Multi Part.

NOTE On the Voice Play display and Multi Play display, holding down the Cursor [^] button then pressing the Cursor [v] button increases the program number by 10, while down the Cursor [v] button then

pressing the Cursor [^] button decreases the program number by 10. On the Voice Edit display and Multi Edit display, holding down the Cursor [^] button then pressing the Cursor [v] button moves the cursor to the parameter at the top of the previous page, while holding the Cursor [v] button then pressing the Cursor [^] button moves the cursor to the parameter at the top of the next page.

6 [AUDITION] button

Pressing this button lets you hear the sound of the Voice selected in the Voice mode or assigned to the current Part in the Multi mode.

When the "Audition Button" parameter (page 99) is set to "audition sw" on the General display of the Utility mode, pressing this button starts/stops the pre-programmed phrase (referred to as "Audition Phrase"). When the "Audition Button" parameter (page 99) is set to "arpeggio sw," pressing this button determines whether the Arpeggio assigned to the current Voice or Multi Part is turned on or off.

NOTE When the "Audition Button" parameter (page 99) is set to "audition sw" on the General display of the Utility mode, holding the [AUDITION] button for two seconds or more in the Voice mode calls up the Audition setup page of the Play Mode display (page 65). When the "Audition Button" parameter (page 99) is set to "arpeggio sw" on the General display of the Utility mode, holding the [AUDITION] button for two seconds or more in the Voice mode or Multi mode calls up Arp Select display of the Voice Common Edit or Multi Part Edit.

7 [STORE] button

Pressing this button stores the edited Voice, Multi and Utility settings to internal memory (page 46).

8 [ENTER] button

Use this button to actually enter a number when selecting a Memory or Bank for Voice or Multi. Also use this button to execute a Store operation or play the demo songs.

9 [EXIT] button

The menus and displays are organized according to a hierarchical structure. Press this button to exit from the current display and return to the previous level in the hierarchy.

10 [VOICE] button

Use this button to enter the Voice mode (pages 27 and 64). Pressing this button calls up the Voice Play display (page 27); this enters the Voice mode and turns the lamp on. In the Voice mode, this button's lamp flashes when MIDI messages are received from an external MIDI device or computer.

11 [EFFECT] button

Pressing this button calls up the Effect dialog (page 34). Holding this button for two seconds or more calls up the Effect display in the current mode.

NOTE When you select the Voice/Multi that is set the Insertion Effect, System Effect (Reverb, Chorus), and Master Effect to on, this button's lamp will light.

12 [EDIT] button

Pressing this button calls up the Edit Select display in the Voice mode/Multi mode.

13 [MULTI] button

Use this button to enter the Multi mode (pages 35 and 91). Pressing this button calls up the Multi Play display (page 35); this enters the Multi mode and turns the lamp on. In the Multi mode, this button's lamp flashes when MIDI messages are received from an external MIDI device or computer.

14 [SELECT] button

Pressing this button changes the functions assigned to the five knobs. The lamp next to the currently active parameters will light (page 30). When the "Knob Sel Disp Sw" parameter (page 99) is set to "on" in the General display of the Utility mode, pressing this button calls up the Knob Select pop-up window (page 29).

15 [UTILITY] button

Use this button to call up the Utility parameters. Pressing this button calls up the Utility Select window (page 98) for the relevant Utility parameters of the currently selected mode.

16 Knobs 1 – 5 (page 29)

These five highly versatile knobs let you adjust various parameters such as Voice or Multi settings and Arpeggio tempo. Pressing or turning any of the knobs calls up the Knob pop-up window (page 29), according to the setting of the "Knob Disp Time" parameter (page 99) in the General window of the Utility mode.

Functions performed by operating two controllers**[EDIT] and [UTILITY]**

Pressing the [EDIT] and [UTILITY] buttons simultaneously enters the Demo mode (page 15).

[VOICE] and [STORE]

In the Voice mode, pressing the [STORE] button while holding the [VOICE] button transmits the bulk data of the current Voice to the external MIDI device.

[MULTI] and [STORE]

In the Multi mode, pressing the [STORE] button while holding the [MULTI] button transmits the bulk data of the current Multi settings to the external MIDI device.

[MULTI] and [ENTER]

In the Multi mode, pressing the [ENTER] button while holding the [MULTI] button initializes all settings for the selected Multi.

[UTILITY] and Encoder knob

Turning the Encoder knob while holding the [UTILITY] adjusts the LCD for optimum legibility (page 99).

Rear Panel

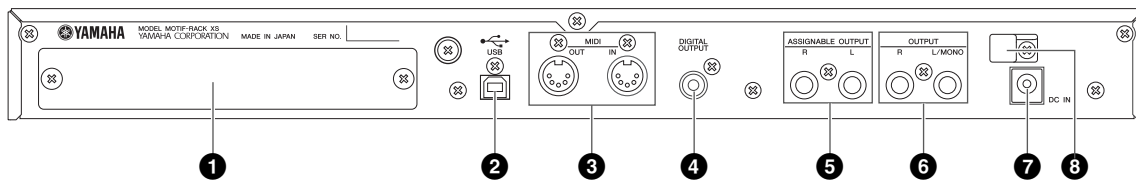

1 mLAN expansion board (mLAN16E2) cover (page 108)

The optional mLAN16E2 can be installed by removing this cover. By installing a mLAN16E2 board, you can upgrade your MOTIF-RACK XS for convenient and easy connection to an IEEE1394-compatible computer.

■ When the optional mLAN16E2 has been installed:

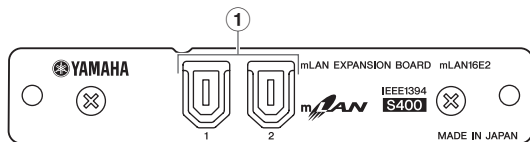

1 mLAN (IEEE1394) terminal 1, 2

For connecting mLAN devices or IEEE1394-compatible (FireWire) devices via standard IEEE1394 (6-pin) cables.

NOTE Yamaha recommends that you use an IEEE1394 cable with a length of 4.5 meters or less.

About mLAN



"mLAN" is a digital network designed for musical applications. It uses and extends the industry standard IEEE1394 high performance serial bus. By connecting the MOTIF-RACK XS to a computer in a peer-to-peer connection via an IEEE1394 cable, you can transfer audio data for all channels and MIDI data for all ports simultaneously between the MOTIF-RACK XS and the computer. This kind of connection, its capabilities and uses are referred to as "mLAN" in this Owner's Manual and the MOTIF-RACK XS instrument.

For details and the latest information on mLAN, refer to the following URL:
<http://www.yamahasynth.com/>

*The name "mLAN" and its logo (above) are trademarks of Yamaha Corporation.

2 USB TO HOST terminal (page 17)

The USB TO HOST terminal is used to connect this instrument to the computer via the USB cable and allows you to transfer MIDI data between the devices.

USB

USB is an abbreviation for Universal Serial Bus. It is a serial interface for connecting a computer with peripheral devices, and enables much faster data transfer compared to conventional serial port connections.

3 MIDI IN/OUT terminal

MIDI IN is for receiving control or performance data from another MIDI device, such as an external sequencer, letting you control the MOTIF-RACK XS from the connected separate MIDI device. MIDI OUT is for transmitting all control (via knobs and buttons) and playback data from the MOTIF-RACK XS to another MIDI device, such as an external sequencer.

When the "MIDI Soft Thru" parameter (page 100) is set to "on" in the MIDI display of the Utility mode, MIDI messages received via MIDI IN are forwarded through MIDI OUT.

4 DIGITAL OUTPUT terminal

Use this terminal to output digital signals via a coaxial (RCA-pin) cable. The digital signal format is CD/DAT (S/P DIF). This terminal outputs a digital signal of 44.1 kHz/24 bit. By using this jack, you can record the keyboard performance or Song/Pattern playback of this synthesizer to external media (e.g., a CD recorder) with exceptionally high-quality sound—thanks to the direct digital connection.

5 ASSIGNABLE OUTPUT L and R jacks

Line level audio signals are output from this instrument via these phone jacks (1/4" mono phone plug). These outputs are independent of the main output (at the L/MONO and R jacks below), and can be freely assigned to any of the Drum Voice keys or the Parts. This lets you route specific Voices or sounds for processing with a favorite outboard effect unit. The Parts which can be assigned to these jacks are as follows:

- Audio Parts in the Voice mode (page 102)
- Drum Voice keys to which drum/percussion instruments have been assigned (page 85)
- Any Part of a Multi* (pages 92 and pages 95)

*Includes the Audio Input Part (mLAN IN Part)

6 OUTPUT L/MONO and R jacks (page 13)

Line level audio signals are output via these phone jacks. For monophonic output, use just the L/MONO jack.

7 DC IN terminal (page 13)

Connect an AC power adaptor to this jack.

⚠ WARNING

Use only the included power adaptor (or an equivalent recommended by Yamaha). Use of a different adaptor may result in equipment damage, overheating, or fire. Doing so will also immediately void the product warranty, even if the effective warranty period has not expired.

8 Cable Clip (page 13)

Wrap the DC output cable of the adaptor around this cable clip to prevent accidental unplugging of the cable during operation.

Setting Up

Power Supply

Connect the supplied AC power adaptor in the following order. Before you connect the power adaptor, make sure that the [VOLUME] knob is set to STANDBY (Off).

1. Connect one end of the AC cable to the power adaptor.
2. Connect the plug of the power adaptor to the DC IN terminal on the rear panel of the MOTIF-RACK XS.
3. Plug in the AC cable to an appropriate AC outlet.

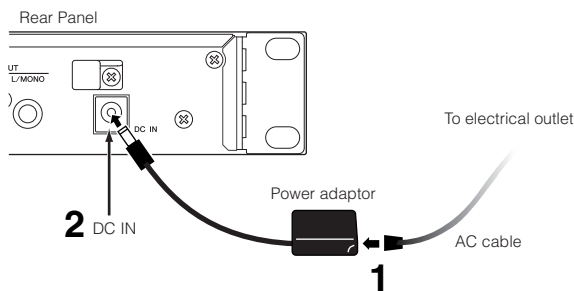

NOTE Follow this procedure in reverse order when disconnecting the power adaptor.

WARNING

Use the specified adaptor (or an equivalent recommended by Yamaha). Using the wrong adaptor can result in damage to the instrument or overheating.

CAUTION

Make sure your MOTIF-RACK XS is rated for the AC voltage supplied in the area in which it is to be used (as listed on the rear panel). Connecting the unit to the wrong AC supply can cause serious damage to the internal circuitry and may even pose a shock hazard!

CAUTION

Even when the [VOLUME] knob is in the "STANDBY" position, electricity is still flowing to the instrument at the minimum level. When not using the MOTIF-RACK XS for an extended period of time, be sure to unplug the AC power adaptor from the wall AC outlet.

Cable Clip

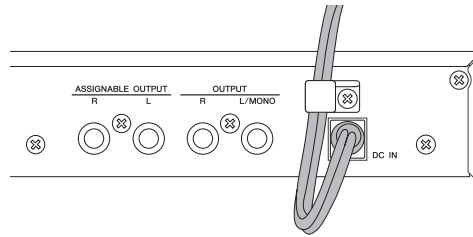

Wrap the DC output cable of the adaptor around the cable clip (as shown above) to prevent accidental unplugging of the cable during operation. Avoid tightening the cord more than necessary or pulling on the cord strongly while it is wrapped around the cable clip to prevent wear on the cord or possible breakage of the clip.

Using Headphones or Speakers

Since the MOTIF-RACK XS has no built-in speakers, you'll need an external audio system or a set of stereo headphones to properly monitor it. Connect a set of headphones, powered speakers, or other playback equipment as illustrated below. When making connections, be sure that your cables have the appropriate ratings.

A pair of powered speakers can accurately produce the instrument's rich sounds with their own pan and effect settings. Connect your powered speakers to the OUTPUT L/MONO and R jacks on the rear panel.

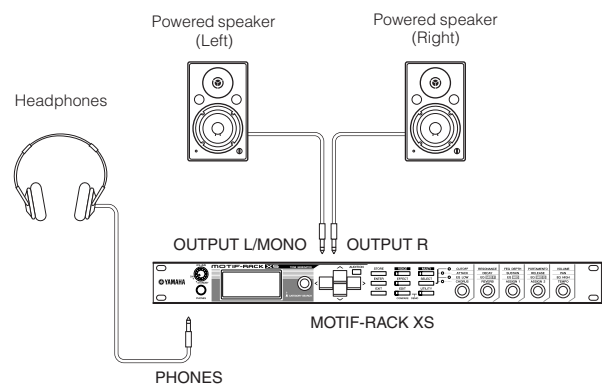

NOTE When using just one powered speaker, connect it to the OUTPUT L/MONO jack on the rear panel.

Power-on Procedure

Once you've made all the necessary connections (pages 13 and 21) between your MOTIF-RACK XS and any other devices, make sure that all volume settings are turned down all the way to zero, then turn on each device in order: first, MIDI masters (senders), MIDI slaves (receivers), then audio equipment (mixers, amplifiers, speakers, etc.). This ensures smooth signal flow from the first device to the last (first MIDI, then audio).

NOTE To turn off the power to the devices, first lower the volume of the audio equipment, then turn off the power in the reverse sequence.

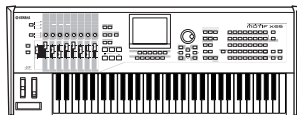

MIDI master (transmitting device)



MOTIF-RACK XS as MIDI slave
(MIDI receiving device)

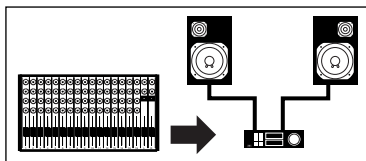

Audio equipment
(mixer first, then amplifier)

Turning the Power On/Off

⚠ CAUTION

To protect your speakers, before you turn the power to the MOTIF-RACK XS on or off, lower the volume setting on the MOTIF-RACK XS and connected audio equipment.

1. Turn the [VOLUME] knob from the STANDBY position to the ON position to turn the power on.

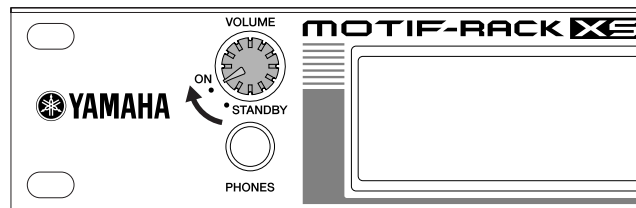

The opening message appears in the LCD. After a while, the default display appears.

NOTE You can set the default display in the "Power On Mode" parameter ([UTILITY] → General window). For details, see page 98.

NOTE If the LCD is difficult to read, you may need to adjust the display contrast. To do this, simultaneously hold down the [UTILITY] button and turn the Encoder knob.

2. Raise the sound system volume to a reasonable level.
3. Turn the [VOLUME] knob clockwise to set an appropriate volume level.
4. When you want to turn the MOTIF-RACK XS off, first turn down the volume of all the connected audio equipment then turn the power to each device off.

Listening to the Sound

Demo Playback

The MOTIF-RACK XS features a variety of demo songs, showcasing its dynamic sound and sophisticated functions. Here's how to play them back.

NOTE Make sure the MOTIF-RACK XS is ready for playback. Details are given in the section "Setting Up" on page 13.

1. Simultaneously hold the [EDIT] button and press the [UTILITY] button.

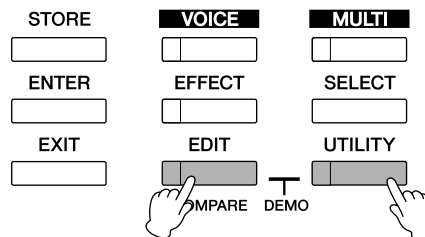

2. From the Demo Song Play display, select the desired Song by using the Encoder knob, or Cursor [^] and [v] buttons.

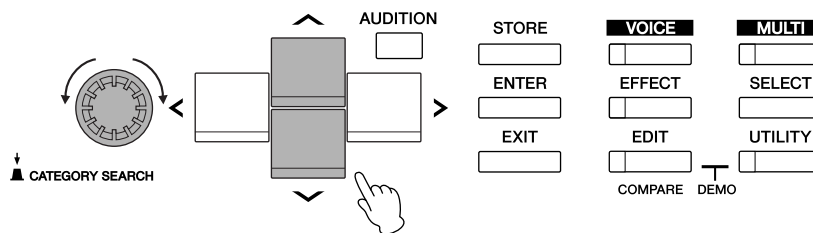

3. Press the [ENTER] button or Encoder knob to start the selected Demo Song.

Pressing the [ENTER] button or Encoder knob during playback stops playback at the current point in the Song then pressing this again starts playback from that point.

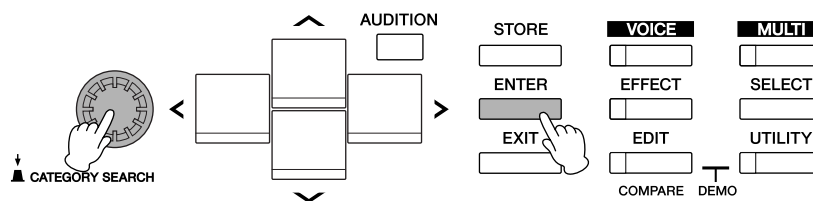

4. To stop playback, press the [EXIT] button.

5. To close the Demo Song display, press any of the [EXIT], [VOICE] and [MULTI] buttons.

Audition Phrase Playback

Audition Phrases let you quickly and easily check the sound of the Voice you've selected. This is convenient when going through the wide variety of Voices available and trying to select the most suitable one for your song or performance.

Listening to the Audition Phrase of the desired Voice

1. Press the [VOICE] button.

The [VOICE] lamp lights and the Voice Play display of the Voice mode appears.

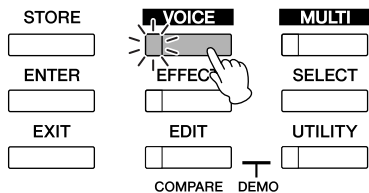

2. Select the desired Voice by using the Cursor buttons and Encoder knob.

3. Press the [AUDITION] button.

The [AUDITION] lamp flashes and the Audition Phrase of the selected Voice will play back.

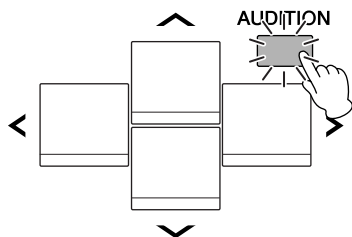

When another Voice is selected during playback, the Audition Phrase of the new Voice automatically starts.

NOTE If pressing the [AUDITION] button produces no sound, follow the instructions titled "When pressing the [AUDITION] button produces no Audition Phrase" below.

4. Press the [AUDITION] button again to stop the Audition Phrase playback.

The Audition Phrase is available also in the Voice Edit mode (page 31) and Multi mode (page 35). In the Multi mode, you can hear the Audition Phrase of the Voice assigned to the current Part.

When pressing the [AUDITION] button produces no Audition Phrase:

If pressing the [AUDITION] button produces no sound, make sure the setting is appropriate by following the instructions below.

1. Press the [UTILITY] button.

The Utility Select window appears.

2. Select "General" by using the Encoder knob and Cursor buttons, then press the [ENTER] button.



(This display can be called up from the Voice mode.)

3. Press the Cursor [^]/[V] to call up the third page of the Utility General window, then select "Audition Button."



4. Set the "Audition Button" parameter to "audition sw" by turning the Encoder knob.

This setting enables the [AUDITION] button for playback of the Audition Phrase.

Playback variation of the Audition Phrase

The type and pitch of the Audition Phrase assigned to the each Voice can be changed as desired by setting the following parameters in the Play Mode display (page 66) of Voice Common Edit.

- **Audition No. (Audition Phrase number)**
Determines the type of the Audition Phrase.
- **Audition Note Shift**
Shifts the playback notes of the Audition Phrase in semitones.
- **Audition Vel Shift (Audition Phrase Velocity Shift)**
Increases or decreases the velocities for the playback notes of the Audition Phrase.

NOTE Some Audition Phrases include Control Change messages which control the tonal characteristics of the Voice.

NOTE When the "Audition Button" parameter is set to "audition sw," holding the [AUDITION] button for two seconds or more calls up the Play Mode display (page 65) containing the above parameters.

NOTE Even within the same Audition Phrase type, the playback sound will differ depending on the Arpeggio setting of the each Voice or Part in the Multi.

Connections

Connecting to a Computer and MIDI Device

Connecting this instrument to a computer via MIDI opens up a whole world of musical possibilities—such as using DAW software to record and play back compositions with the MOTIF-RACK XS sounds or using the Voice Editor software (free for downloading from the Yamaha web site) to create and edit your own custom Voices. By connecting a MIDI keyboard to your MOTIF-RACK XS/computer setup, you can use the MOTIF-RACK XS to play back both song data on the DAW and your keyboard performance.

NOTE When using an external keyboard to play the MOTIF-RACK XS sounds while connecting the MOTIF-RACK XS to a computer, you'll need to use the MIDI Thru function of the DAW software on the computer to re-transmit received MIDI data to the MOTIF-RACK XS (Port 1). If not using the DAW software, use the MIDI Thru function of the Studio Manager version 2.3.0 or later.

NOTE For details about connection between the computer and the external keyboard or between the computer and the synthesizer, refer to the owner's manual of the particular devices.

Connection example 1:

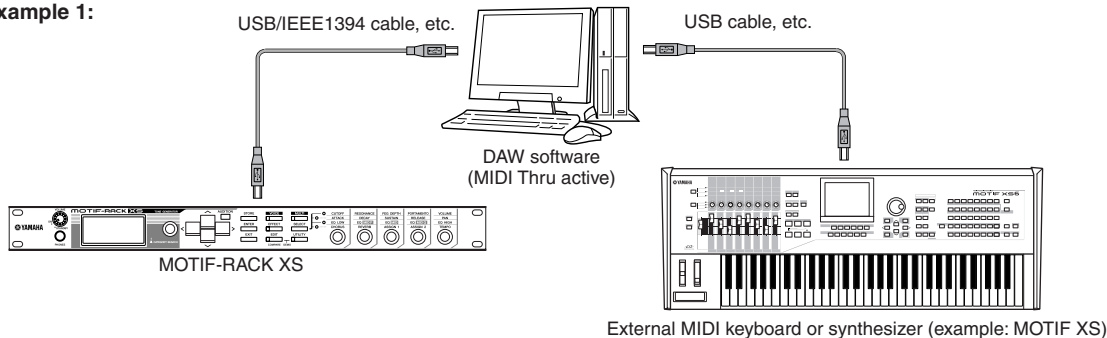

Connection example 2*:

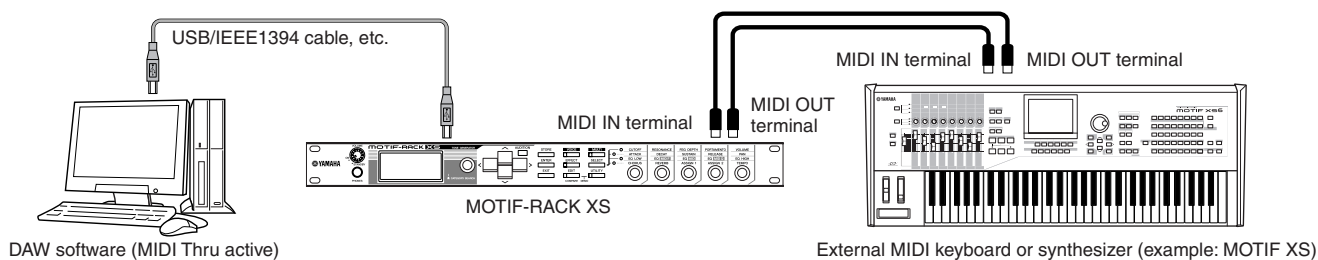

* In connection example 2, the received MIDI data from an external keyboard is transmitted through the MOTIF-RACK XS to the connected computer. If MIDI Thru is enabled in the client application, MIDI data is re-transmitted to the MOTIF-RACK XS. For details, refer to the "Using the Thru Port" (page 18).

Connection between the MOTIF-RACK XS and a computer

Using a USB TO HOST terminal

This section shows you how to connect the MOTIF-RACK XS to a computer via a USB cable. Note that the MIDI data can be transmitted through a USB cable.

NOTE Since the MOTIF-RACK XS has no built-in speakers, you'll need an external audio system or a set of stereo headphones to properly monitor it. For details, refer to "Setting Up" on page 13.

1. Download the USB-MIDI driver from our website:

http://www.global.yamaha.com/download/usb_midi/

NOTE Information on system requirements is also available at the above web site.

NOTE The USB-MIDI driver may be revised and updated without prior notice. Make sure to check and download the latest version from the above site.

2. Install the downloaded USB-MIDI driver to the computer.

For instructions on installing, refer to the online Installation Guide included in the downloaded file package. When connecting the MOTIF-RACK XS to a computer in the Installation procedure, connect the USB cable to the USB TO HOST of the MOTIF-RACK XS and the USB terminal of the computer as shown below.

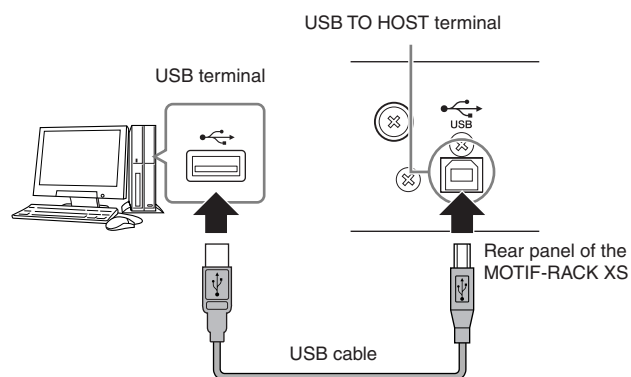

3. Make sure that the USB TO HOST terminal of the MOTIF-RACK XS is enabled.

Press the [UTILITY] button to call up the Utility Select window, then select "MIDI" in the window. Then, press the [ENTER] button or Encoder knob to call up the MIDI window (page 99) and set the "MIDI In/Out" parameter to "USB."

4. Press the [STORE] button to store this setting.

Precautions when using the [USB TO HOST]

When connecting the computer to the [USB TO HOST] terminal, make sure to observe the following points. Failing to do so risks freezing the computer and corrupting or losing the data. If the computer or the instrument freezes, restart the application software or the computer OS, or turn the power to the instrument off then on again.

CAUTION

- Use an AB type USB cable of less than about 3 meters.
- Before connecting the computer to the [USB TO HOST] terminal, exit from any power-saving mode of the computer (such as suspended, sleep, standby).
- Before turning on the power to the instrument, connect the computer to the [USB TO HOST] terminal.
- Execute the following before turning the power to the instrument on/off or plugging/unplugging the USB cable to/from the [USB TO HOST] terminal.
 - Quit any open application software on the computer.
 - Make sure that data is not being transmitted from the instrument. (Data is transmitted on the MOTIF-RACK XS by using Knobs 1 - 5.)
- While the computer is connected to the instrument, you should wait for six seconds or more between these operations: (1) when turning the power of the instrument off then on again, or (2) when alternately connecting/disconnecting the USB cable.

MIDI channels and MIDI ports

MIDI song data can be sent independently over sixteen separate channels, and this instrument is capable of simultaneously playing sixteen separate parts via these channels. While a single MIDI cable is equipped to handle data over up to sixteen channels simultaneously, a USB connection or an IEEE1394 connection is capable of handling far more—thanks to the use of MIDI ports. Each MIDI port can handle sixteen channels, and the USB connection or IEEE1394 connection allows up to eight ports, letting you use up to 128 channels (8 ports x 16 channels) on your computer. When connecting the MOTIF-RACK XS to a computer using a USB cable or an IEEE1394 cable, the MIDI ports are defined as follows:

• Port 1

The tone generator block in the MOTIF-RACK XS can recognize and use only this port.

When playing the MOTIF-RACK XS sounds from an external MIDI instrument or computer, you should set the MIDI Port to 1 on the connected MIDI device or computer.

• Port 3

This port is used as the MIDI Thru Port. The MIDI data received over Port 3 via the USB TO HOST or mLAN terminal will be re-transmitted to an external MIDI device or computer via the MIDI OUT terminal. The MIDI data received over Port 3 via the MIDI IN terminal will be retransmitted to an external device (computer, etc.) via the USB TO HOST or mLAN terminal.

NOTE Port 2 is not used. Port 4 is used to synchronize with the MOTIF-RACK XS Editor on the computer when connecting the MOTIF-RACK XS to the computer via the USB TO HOST terminal. We recommend that you avoid using Port 4 for synchronizing with software other than the MOTIF-RACK XS Editor.

When using a USB connection or IEEE1394 connection between the MOTIF-RACK XS and the computer, make sure to match the MIDI transmit port and the MIDI receive port (as well as the MIDI transmit channel and the MIDI receive channel) as described above.

Using the Thru Port

MIDI ports can be used to divide playback among multiple synthesizers, as well as expand the MIDI channel capacity beyond sixteen. In the example below, a separate synthesizer connected to the MOTIF-RACK XS is played by MIDI data via Port 3. Also, the MOTIF-RACK XS can be used as a MIDI Interface by re-transmitting the MIDI data received from an external MIDI device to Port 3 of the USB TO HOST terminal. In the example below, set the MOTIF-RACK XS with the following operation.

[UTILITY] → select "MIDI" in the Utility Select window → [ENTER] → "MIDI In/Out" = "USB"/"mLAN"

When playing the MOTIF-RACK XS sounds by received MIDI data from DAW software on the computer, set the MIDI output port of the tracks (for playing the MOTIF-RACK XS) to Port 1 of USB or mLAN.

External MIDI tone generator or synthesizer

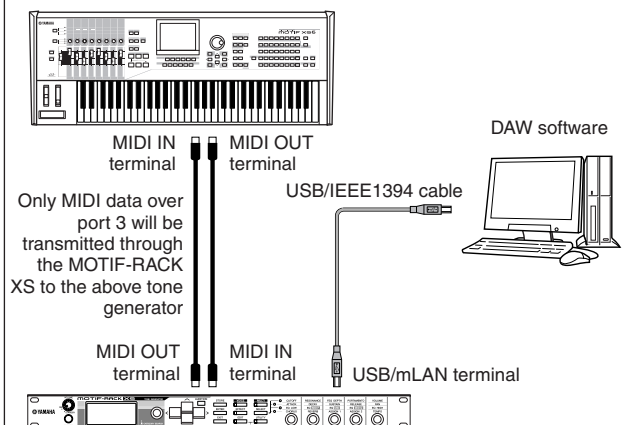

Only MIDI data over ports 1 are received to the MOTIF-RACK XS. Only MIDI data over ports 3 are re-transmitted to the computer or the external MIDI tone generator through the MOTIF-RACK XS.

Using a MIDI terminal

Use a MIDI interface to connect the MIDI terminal of the MOTIF-RACK XS to a computer.

NOTE When connecting the MOTIF-RACK XS to a computer via the MIDI terminal of the MOTIF-RACK XS, the MOTIF-RACK XS and MOTIF-RACK XS Editor cannot communicate with each other.

Using an mLAN terminal

This section shows you how to connect the MOTIF-RACK XS to a computer via an IEEE1394 (FireWire) cable. Note that the audio data as well as MIDI data can be transmitted through an IEEE1394 cable.

NOTE The MOTIF-RACK XS can be connected to a computer equipped with the IEEE1394 terminal only when an optional mLAN16E2 has been installed to the MOTIF-RACK XS. For instructions on installing the mLAN16E2, see page 108.

NOTE When equipped with mLAN, the MOTIF-RACK XS provides greater input/output versatility, with 3 Stereo Inputs, 14 Mono Outputs + 1 Stereo Output (or 8 Stereo Outputs) audio channels and 2 MIDI In/2 MIDI Out channels.

1. Download the proper AI Driver from our website:

<http://www.yamahasynt.com/download/>

NOTE Information on system requirements is also available at the above web site.

NOTE The AI Driver may be revised and updated without prior notice. Make sure to check and download the latest version from the above site.

2. Install the downloaded AI Driver to the computer.

For instructions on installing, refer to the online Installation Guide included in the downloaded file package. When connecting the MOTIF-RACK XS to a computer in the Installation procedure, connect the IEEE1394 cable to the mLAN terminal of the MOTIF-RACK XS and the IEEE1394 terminal of the computer as shown below.

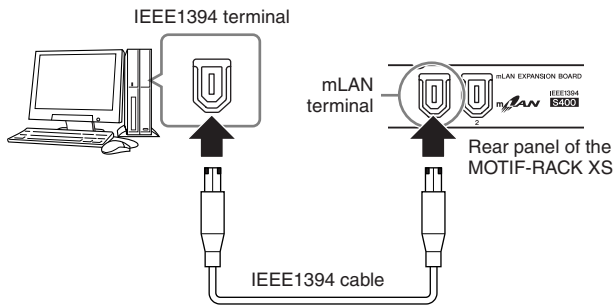

⚠ CAUTION

Be sure to connect the IEEE1394 (mLAN) cable plug to the mLAN jack with the correct orientation.

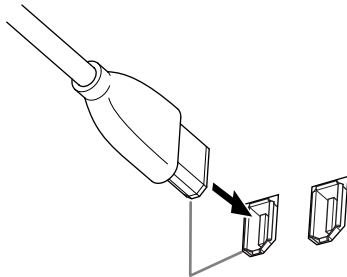

Plug in the jack with the correct orientation.

NOTE For optimum results, use an IEEE1394 cable shorter than 4.5 meters.

3. Make sure that the mLAN terminal of the MOTIF-RACK XS is enabled for MIDI communication.

Press the [UTILITY] button to call up the Utility Select window, then select "MIDI" in the display. Then, press the [ENTER] button or the Encoder knob to call up the MIDI display (page 99) and set the "MIDI In/Out" parameter to "mLAN."

4. Make sure that the mLAN terminal of the MOTIF-RACK XS is enabled for audio communication.

When transmitting audio signals via the mLAN terminal, set the Output Select parameter of the MOTIF-RACK XS. When receiving audio signals via the mLAN terminal, set the mLAN audio input part parameters of the MOTIF-RACK XS. For details, see "Audio signal transmission/reception" in the section "Signal flow of audio and MIDI data via an IEEE1394 cable" on page 20.

5. Press the [STORE] button to store this setting.

What you can do with the IEEE1394 connection

You can integrate the MOTIF-RACK XS with DAW software on a computer by connecting the mLAN equipped MOTIF-RACK XS (which the optional mLAN16E2 is installed) to a computer in a peer-to-peer arrangement. For details, see below.

- Transfer data of multiple audio channels between the MOTIF-RACK XS and the computer (up to 16 channels from the MOTIF-RACK XS to the computer and up to 6 channels from the computer to the MOTIF-RACK XS).
- While playing back sequence software, you can simultaneously record the sounds of the MOTIF-RACK XS back to the sequence software as audio data.
- Monitor via the MOTIF-RACK XS the audio output from the computer and the audio output from the MOTIF-RACK XS.
- Use Cubase 4/ Cubase AI 4 together with the MOTIF-RACK XS with a variety of convenient functions. For details, refer to the section "Integration Between the MOTIF-RACK XS and Cubase" (page 24).

NOTE The capabilities and uses of connecting the MOTIF-RACK XS to a computer via an IEEE1394 cable in a peer-to-peer arrangement is referred to as "mLAN" in this Owner's Manual and the MOTIF-RACK XS instrument. For details and the latest information on mLAN, refer to the following URL: <http://www.yamahasynth.com/>

Signal flow of audio and MIDI data via an IEEE1394 cable

The illustration below shows the flow of audio signals and MIDI messages when connecting the MOTIF-RACK XS and a computer via an IEEE1394 cable.

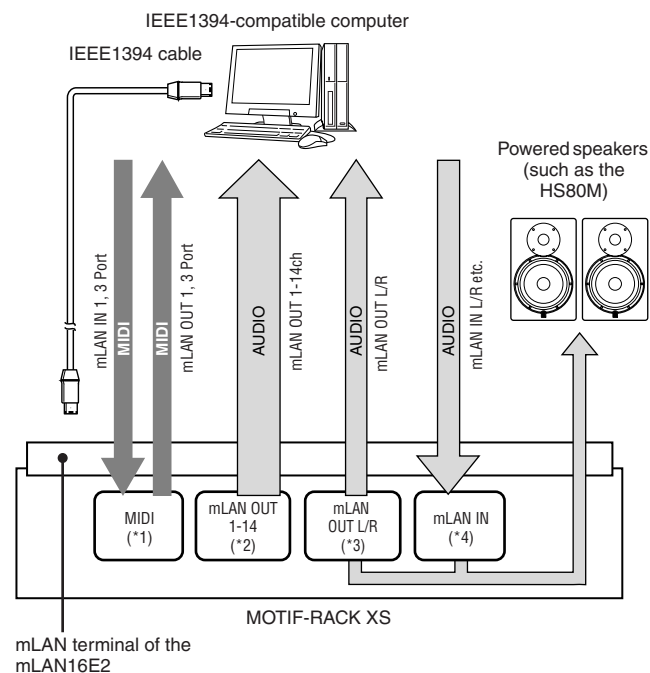

■ mLAN OUT L/R (*3)

The audio signal is output via both the OUTPUT L/MONO, R terminals and mLAN OUT L/R when the “Output Select” parameter described at left (mLAN OUT 1 –14) is set to “L&R.”

Audio signal reception (*4)

The mLAN IN Main Out Monitor L/R and mLAN IN Assignable Out Monitor L/R are available as well as the mLAN IN L/R as the mLAN audio input channel of the MOTIF-RACK XS. These channels can be used for monitoring the sound when using the DAW software on the computer. The audio signal received via the mLAN IN Main Out Monitor L/R will be output via the OUTPUT L/R jacks while the audio signal received via the mLAN IN Assignable Out Monitor L/R will be output via the ASSIGNABLE OUTPUT L/R jacks. Setting the audio output channel on the computer determines which channel is used. As for audio signals received via the mLAN terminal, parameters such as volume and output channel can be applied as the mLAN audio input part of the MOTIF-RACK XS. The display of these parameter settings differs depending on the mode, as listed below.

[VOICE] → [UTILITY] → select “Voice mLAN” in Utility Select window, press [ENTER] → Voice mLAN display (page 102)

[MULTI] → [EDIT] → select “Common” in Edit Select display, press [ENTER] → select “mLAN In” in Common Edit Select display, press [ENTER] → mLAN In display (page 91)

MIDI transmission/reception (*1)

Setting the port on the MOTIF-RACK XS is not necessary since the MIDI Port of the MOTIF-RACK XS is automatically fixed according to the application. For information on which port should be selected on your computer, refer to the section “MIDI channels and MIDI ports” on page 18.

Audio signal transmission

■ mLAN OUT 1 – 14 (*2)

Audio signals are output via mLAN OUT 1 – 14 when the MOTIF-RACK XS “Output Select” parameter is set to any of the settings “m1&2” – “m13&14” and “m1” – “m14” in one of the following displays.

The output destination of audio input signal from the mLAN terminal

[VOICE] → [UTILITY] → select “Voice mLAN” in Utility Select window, press [ENTER] → “Output Select” (page 102)

[MULTI] → [EDIT] → select “Common” in Edit Select display, press [ENTER] → select “mLAN In” in Common Edit Select display, press [ENTER] → “Output Select” (page 92)

The output destination of each Multi’s audio signal

[MULTI] → [EDIT] → select desired part (1 – 16) in Edit Select display, press [ENTER] → select “Play Mode” in Part Edit Select display, press [ENTER] → “Output Select” (page 95)

The output destination of each Key’s audio signal in the Drum Voice

Select Drum Key in Voice mode on MOTIF-RACK XS Editor → “Output Select” in OSC (Oscillator) of Drum Key Edit (page 85)

NOTE The audio signal of a Normal Voice in the Voice mode is always output from both the mLAN OUT L/R and OUTPUT L/MONO, R terminals. The signal cannot be output from mLAN OUT 1 – 14.

Audio Channels of the MOTIF-RACK XS and the computer

When connecting the MOTIF-RACK XS to a computer via an IEEE1394 cable, set the audio channel of the computer referring to the table below.

Input Channel of the MOTIF-RACK XS	Output Channel of the computer
mLAN IN Main Out Monitor L, R	1, 2
mLAN IN L, R	3, 4
mLAN IN Assignable Out Monitor L, R	5, 6
Output Channel of the MOTIF-RACK XS	Input Channel of the computer
mLAN OUT L, R (L&R)	1, 2
mLAN OUT 1 – 14 (m1 – m14)	3 – 16

Connecting to External MIDI Equipment

With a standard MIDI cable (available separately), you can connect an external MIDI device, and control it from the MOTIF-RACK XS. Likewise, you can use an external MIDI device (such as a keyboard or sequencer) to control the MOTIF-RACK XS sounds. Below are several different MIDI connection examples; use the one most similar to your intended setup.

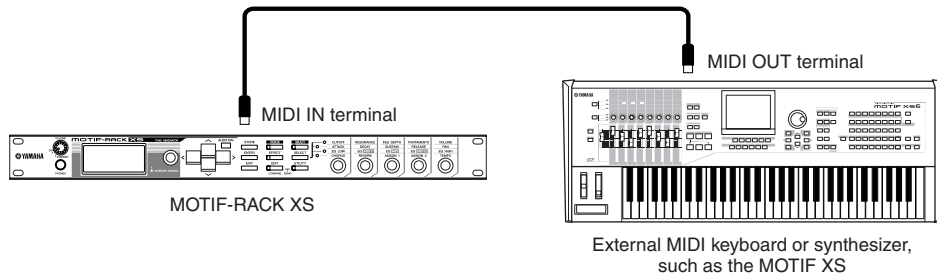

Use an external keyboard to remotely select and play Voices of the MOTIF-RACK XS. In this connection, set the MOTIF-RACK XS as described below.

[UTILITY] → select "MIDI" in the Utility Select window, press [ENTER] → "MIDI In/Out" = "MIDI"

NOTE When a USB cable is not connected to the MOTIF-RACK XS, the MIDI terminal will be automatically used for transmitting/receiving MIDI data, even if this parameter is set to "USB."

NOTE If you want to forward the MIDI messages received via MIDI IN through MIDI OUT, set the MOTIF-RACK XS as described below in addition to the above settings. [UTILITY] → select "MIDI" in Utility Select window, press [ENTER] → "MIDI Soft Thru (MIDI Soft Thru Switch)" = "on"

NOTE For details about MIDI, refer to the section "About MIDI" on page 105.

MIDI Transmit Channel and Receive Channel

Make sure to match the MIDI Transmit Channel of the external MIDI instrument or DAW software with the MIDI Receive Channel of the MOTIF-RACK XS. For details on setting the MIDI Transmit Channel of the external MIDI instrument or DAW software, refer to the owner's manual of your particular instrument/software. For details on setting the MIDI Receive Channel of the MOTIF-RACK XS, check the following points.

In the Voice mode (using the MOTIF-RACK XS as a single timbre tone generator)

Check the MIDI Basic Receive Channel with the following operation. [UTILITY] → select "Voice MIDI" in the Utility Select window, press [ENTER] → "Receive Ch (Basic Receive Channel)" (page 102) If necessary, change this parameter to the same number as the MIDI Transmit Channel of the external MIDI instrument or the DAW software.

In the Multi mode (using the MOTIF-RACK XS as a multi-timbral tone generator)

Check the MIDI Receive Channel for each Part of the Multi with the following operation. [MULTI] → [EDIT] → select desired part (1 – 16) in Edit Select display, press [ENTER] → select "Voice" in Part Edit Select display, press [ENTER] → "Receive Ch (Receive Channel)" (page 94) Change the settings of the desired Parts to match the MIDI Transmit Channel settings on the external MIDI instrument or the DAW software. Please note that all Parts whose MIDI Receive Channels match the MIDI Transmit Channel of the external MIDI instrument or the DAW software are sounded by your keyboard performance.

NOTE For details about the functions of the internal tone generator, see page 50.

Synchronizing with an external sequencer (Master and Slave)

When using multiple MIDI instruments or DAW software, the tempo settings of the MIDI instruments or DAW software must be synchronized by clock signal. The device set to internal clock serves as a reference for all connected devices, and is referred to as the "master" instrument. The connected devices set to external clock are referred to as "slaves."

When using playback data of an external sequencer to trigger the Arpeggio function on the MOTIF-RACK XS, make sure to set the MIDI synchronization parameter in Utility so that the external clock is used (as shown below).

[UTILITY] → select "MIDI" in Utility Select window, press [ENTER] → "MIDI Sync" = "external"/ "auto" (page 99)

In addition, make sure that the external sequencer is set to "master" or internal sync, and set it so that the MIDI clock data is transmitted to Port 1 of the MOTIF-RACK XS (page 43).

NOTE Certain sequencers may not send clock signals to an external device while playback is stopped. When "MIDI Sync" is set to "MIDI," the Arpeggio function is available only while the MOTIF-RACK XS receives clock signals from the master instrument.

Using a Computer

Creating a Song by Using a Computer

By connecting the MOTIF-RACK XS to your computer via USB or mLAN, you can use DAW software on the computer to create your own original songs. This section contains an overview on how to use DAW software on a computer connected to the MOTIF-RACK XS.

NOTE The acronym DAW (digital audio workstation) refers to music software for recording, editing and mixing audio and MIDI data. The main DAW applications are Cubase, Logic, SONAR and Digital Performer. Though all of these can be effectively used with the MOTIF-RACK XS, we recommend using Cubase when creating songs together with the instrument.

Song playback from a computer using the MOTIF-RACK XS sounds

The instructions below show how to use the Multi mode of the MOTIF-RACK XS as a MIDI tone generator. In this case, actual MIDI sequence data is transmitted from a DAW software on the computer.

Setting up the MOTIF-RACK XS

1. Press the [MULTI] button to enter the Multi mode.
2. Select a Multi using the Encoder knob or the Cursor [^]/[V] buttons.
3. Press the [EDIT] button to enter Multi Edit.
4. Change the setting for Parts 1 – 16 as necessary.

For details about Multi Edit, see pages 36.

Setting up the DAW on the computer

1. Set the MIDI output port of the tracks (for playing the MOTIF-RACK XS) to Port 1 of USB or mLAN.

When connecting via a USB cable, set this to "Yamaha MOTIF-R XS-1" or "YAMAHA MOTIF-R XS Port1." When connecting via an IEEE1394 cable, set this to "mLAN MIDI Out" or "MOTIF-RACK XS."

2. Enter the MIDI data to each track of the DAW on the computer.

The tone generator settings of the part corresponding to the MIDI track will be set in the Multi mode on the MOTIF-RACK XS.

NOTE By using the MOTIF-RACK XS Editor, you can create your original Mixing setup of the MOTIF-RACK XS from your computer. The created Mixing setup can be saved as a file for future recall.

NOTE You can use the MOTIF-RACK XS Editor as a plug-in software within Cubase and save the edited Mixing setup of the MOTIF-RACK XS as a Cubase project file.

Using another synthesizer together with the MOTIF-RACK XS

By using another synthesizer (such as the MOTIF XS) together with the MOTIF-RACK XS as illustrated in the example below, you can play up to 32 Parts simultaneously.

Setting up the MOTIF-RACK XS

1. Connect the MIDI OUT terminal to the MIDI IN terminal of the external synthesizer such as MOTIF XS, as illustrated below.
2. Press the [MULTI] button to enter the Multi mode, and select the desired Multi.

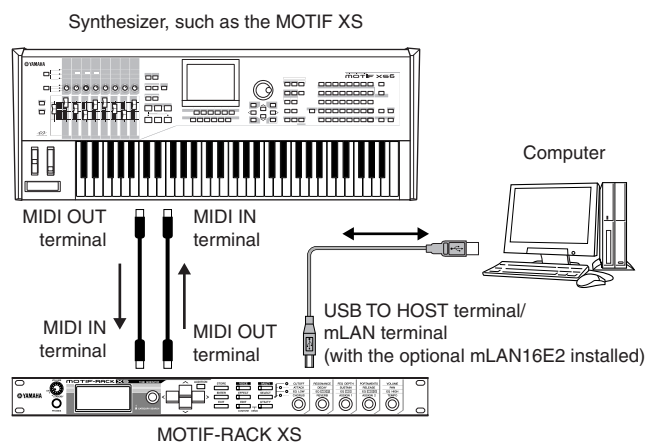

Setting up the DAW on the computer

1. Set the MIDI output port of the tracks (for playing the MOTIF-RACK XS) to Port 1 of USB or mLAN.

When connecting via a USB cable, set this to “Yamaha MOTIF-R XS-1” or “YAMAHA MOTIF-R XS Port1.” When connecting via an IEEE1394 cable, set this to “mLAN MIDI Out” or “MOTIF-RACK XS.”

2. Set the MIDI output port of the tracks (for playing the connected synthesizer) to Port 3 of USB or mLAN.

When connecting via a USB cable, set this to “Yamaha MOTIF-R XS-3” or “YAMAHA MOTIF-R XS Port3.” When connecting via an IEEE1394 cable, set this to “mLAN MIDI Out (3)” or “MOTIF-RACK XS MIDI OUT.”

NOTE Please keep in mind that the MIDI Thru Port of the MOTIF-RACK XS (in other words, the port with which the received MIDI data is to be transmitted to another external device via the MIDI OUT terminal) is fixed to 3.

Using the MOTIF-RACK XS Editor

The MOTIF-RACK XS Editor lets you edit detailed settings of the MOTIF-RACK XS (such as the Element/Key parameters), providing even greater editing convenience and versatility. Furthermore, the data between the MOTIF-RACK XS Editor and the MOTIF-RACK XS (transmitted via USB or IEEE1394) is always kept in synchronization—meaning that any changes you make on one device are immediately reflected in the other. This provides a smooth, seamless interface, and makes it very easy to create and edit your data.

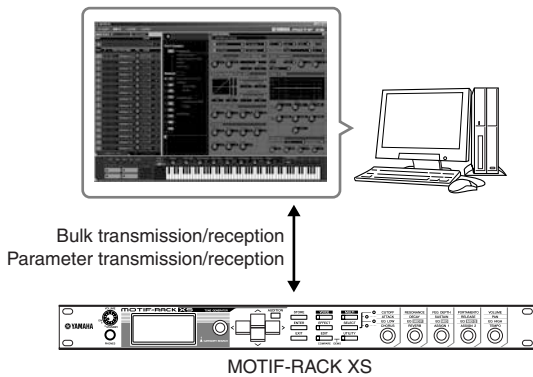

When the MOTIF-RACK XS Editor is used as a stand-alone editor, Studio Manager V2 is used as a host application. Studio Manager is a cross-platform application that enables you to start multiple Editors that control Yamaha hardware products remotely, and to save multiple Editor settings. You can run Studio Manager as a stand-alone application, or as a plug-in within DAW applications.

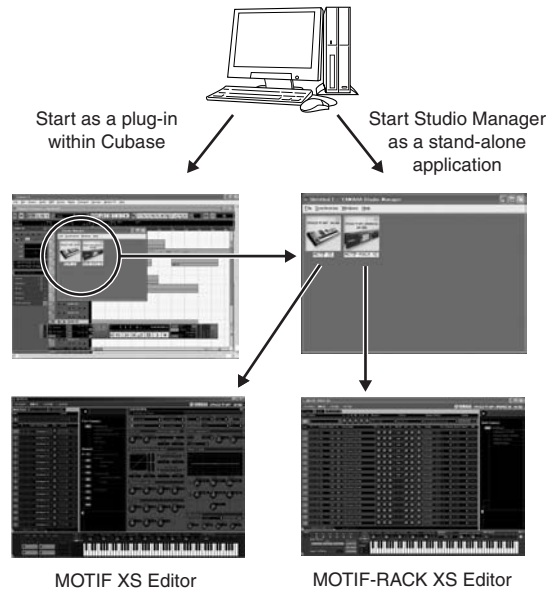

The Studio Manager and MOTIF-RACK XS Editor can be downloaded from the following URL. Use them after installing all necessary software to the computer by following the Installation Guide of the MOTIF-RACK XS Editor.
<http://www.yamahasyth.com/download/>

For information about the minimum system requirements, refer to the Installation Guide of each software.

For instructions on using Studio Manager and MOTIF-RACK XS Editor, refer to the respective PDF manuals included with the software.

Common applications for the MOTIF-RACK XS Editor

■ Using as a stand-alone editor.

The MOTIF-RACK XS Editor is a client application using Studio Manager as host. To use the MOTIF-RACK XS Editor, start Studio Manager then start the MOTIF-RACK XS Editor as a plug-in software within the Studio Manager.

NOTE When using an external keyboard to play the MOTIF-RACK XS sounds while connecting the MOTIF-RACK XS to a computer, you'll need to use the MIDI Thru function of the DAW software on the computer to re-transmit received MIDI data to the MOTIF-RACK XS (Port 1). If not using the DAW software, use the MIDI Thru function of the Studio Manager version 2.3.0 or later.

■ Using within Cubase

The MOTIF-RACK XS Editor can be started as a plug-in software within Cubase. For instructions on starting in this case, refer to the owner's manual of the MOTIF-RACK XS Editor.

NOTE For Windows computers, the MOTIF-RACK XS Editor can be used with Cubase SX3 or later. For Macintosh computers, the MOTIF-RACK XS Editor can be used with Cubase 4 or later.

Integration Between the MOTIF-RACK XS and Cubase

Yamaha and Steinberg have formed a partnership to develop a useful and convenient environment for effectively using Yamaha hardware (including the MOTIF-RACK XS) together with Steinberg software. This section explains how you can use Cubase 4/ Cubase AI 4 and the special joint Yamaha/Steinberg Studio Connections software. For more details, including the latest information and software downloads, refer to the following URL.

<http://www.yamahasynth.com/download/>

What you can do by using Cubase 4/ Cubase AI 4 together with the MOTIF-RACK XS

IMPORTANT

To use the following features and operations, you'll first need to install the AI driver and Extensions for Steinberg DAW.

Automatic setting of the IEEE1394 connection

When using a hardware tone generator such as the MOTIF-RACK XS with computer software, a variety of settings—such as audio connection, driver setup and port setup—must be made. Those complicated settings will be made automatically for you as soon as you connect the MOTIF-RACK XS to a computer via an IEEE1394 cable.

Indicating the Audio/MIDI port including the model name

When connecting via an IEEE1394 cable, the Device Setup window of the Cubase indicates the Audio Port or MIDI Port including the model name such as "MOTIF-RACK XS Main L" and "MOTIF-RACK XS," making it easy to confirm the current connection or change the connection. For details, see the illustration below.

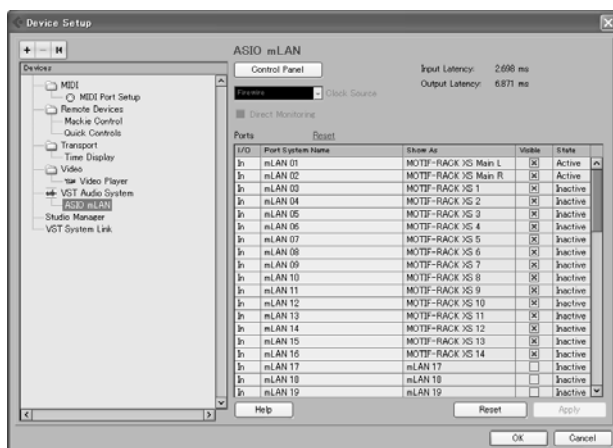

Using the Project Template for multi-channel audio recording

When creating a new project file within Cubase, you can select the template for multi-channel audio recording using the MOTIF-RACK XS via an IEEE1394 cable. By selecting a template, you can easily perform the recording in Cubase without having to make complicated or detailed settings.



For details refer to the following page:

<http://www.yamahasynth.com/>

Studio Connections

What is Studio Connections?



Studio Connections is a sophisticated software/hardware solution that lets you seamlessly integrate hardware synthesizers such as MOTIF-RACK XS into your computer music system. If you are

using sequencer software that is compatible with Studio Connections (such as Cubase 4) and the MOTIF-RACK XS Editor, you can use the MOTIF-RACK XS within your sequencer, just as if it were a plug-in software synthesizer—without the need for any complicated connections or complex setup procedures. Furthermore, you can save all MOTIF-RACK XS settings along with the project (song) file of the sequencer. Then, when you open the project again, all your MOTIF-RACK XS settings for the song are instantly recalled. This eliminates the repetitive work of recreating all your hardware settings when you reopen a song file.

For details about Studio Connections, visit our web site at:

<http://www.studioconnections.org/>

Quick Guide

Modes of MOTIF-RACK XS and Basic Operation

In order to make operation of the MOTIF-RACK XS as comprehensive and as smooth as possible, all functions and operations have been grouped in “modes.” In this section, we’ll take a look at the fundamental operating conventions of the MOTIF-RACK XS. Here, you’ll learn the basics—how to select modes and call up the various functions. You can play the MOTIF-RACK XS in the two modes below. You can select the desired mode, to suit your particular playing style, music genre or production environment.

Voice Mode

The Voice mode (page 27) lets you play a wide range of dynamic and authentic instrument sounds (Voices). Only one Voice can be played simultaneously. Use this mode when you want to play just a single Part. The Voices of the MOTIF-RACK XS are divided into the following two types:

- Normal Voices (pitched musical instrument-type sounds)
- Drum Voices (percussion/drum sounds)

Multi Mode

The Multi Mode (page 35) lets you set up the MOTIF-RACK XS as a multi-timbral tone generator for use with computer-based DAW software or external sequencers. You can play various Voices (up to 16 Parts) simultaneously. By assigning different Voices to each track in a song file of your sequencer, you can play back a complex band or ensemble performance with just a single MOTIF-RACK XS.

In addition, the MOTIF-RACK XS provides the following functions.

Arpeggio (page 40)	This function lets you trigger rhythm patterns, riffs and phrases using the current Voice by simply playing notes on an external keyboard.
Control Set (page 44)	This function lets you control the various functions of the MOTIF-RACK XS with an external MIDI controller.
Store (page 46)	This lets you save the edited Voices and various settings to the MOTIF-RACK XS.
Utility (page 98)	This lets you set the overall system of the MOTIF-RACK XS.

The modes of the MOTIF-RACK XS

The chart below lists all the modes of the MOTIF-RACK XS, their general functions and how each can be called up or entered.

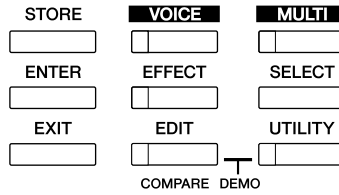

Mode	Function	Entering a mode
Voice mode		
Play	Playing a Voice.	[VOICE]
Common Edit	Editing/creating the parameters common to all Elements/Keys of the selected Voice.	[VOICE] → [EDIT]
Element/Key Edit	Editing/creating the individual Elements/Keys of the selected Voice.	Can only be edited on the MOTIF-RACK XS Editor
Store	Storing a Voice	[VOICE] → [STORE]
Utility	Edit the Master Effect and Master EQ settings, etc.	[VOICE] → [UTILITY]
Multi mode		
Play	Playing a Multi.	[MULTI]
Common Edit	Editing/creating the parameters common to all Parts of the selected Multi.	[MULTI] → [EDIT] → select "Common" in the Multi Edit Select display → [ENTER]
Part Edit	Editing/creating the individual Parts of the selected Multi.	[MULTI] → [EDIT] → select "1" – "16" in the Multi Edit Select display → [ENTER]
Store	Storing a Multi.	[MULTI] → [STORE]
Other Functions		
Utility	Making overall system settings.	[UTILITY]
Effect on/off	Turning the Effects on/off.	[EFFECT]
Category Search	Selecting a Voice using the Category Search function.	Press the Encoder knob in the Voice Select display.

How to leave the current display

If you want to return from the current display to the previous one, press the [EXIT] button.

You can return back to any of the previously selected basic displays (Voice Play display and Multi Play display) by pressing the [EXIT] button several times.

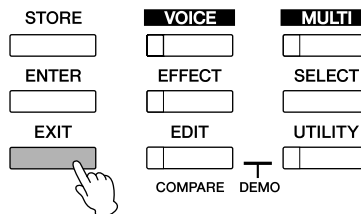

NOTE Parameters are divided into two basic groups: (1) functions that are related to each Voice and Multi, and (2) functions that affect all Voices/ Multis. The former are set in the Voice/ Multi Edit mode and latter in the Utility.

NOTE The parameter settings in the Voice mode, Multi mode, and Utility can be stored to User memory with the store function (page 46).

Voice Mode

In this section, you'll learn about the Voice mode, the most basic mode of the MOTIF-RACK XS.

Playing the Voices

In the Voice Play display (the top display of the Voice Mode), you can select and play a single Voice.

The Voices of the MOTIF-RACK XS are divided into the following two types:

Normal Voices

Normal Voices are mainly pitched musical instrument-type sounds (piano, organ, guitar, synthesizer etc.) that can be played over the range of an external keyboard.

Drum Voices

Drum Voices are mainly percussion/drum sounds that are assigned to individual notes. These Voices are used to perform rhythm parts.

The MOTIF-RACK XS features Banks for memorizing Voices. There are basically three different types of Banks: Preset, User, and GM.

The contained Voices and features depend on the Bank as described below.

Preset Banks

The Preset Banks contain a full set of specially programmed Voices. Voices you've edited yourself cannot be saved in the Preset Banks.

User Banks

The User Banks contain the Voices you have edited and stored. These are picked up from Preset Voices by default

NOTE If a Voice in a User Bank (User Voice) is overwritten or replaced, that User Voice will be lost. When you store an edited Voice, be careful not to overwrite any important User Voices.

GM Bank

The GM Bank contains the Voices allocated according to the GM standard.

GM Voices

GM (General MIDI) is a worldwide standard for Voice organization and MIDI functions of synthesizers and tone generators. It was designed primarily to ensure that any song data created with a specific GM device would sound virtually the same on any other GM device—no matter the manufacturer or the model. The GM Voice bank on this tone generator is designed to appropriately play back GM song data. However, keep in mind that the sound may not be exactly the same as played by the original tone generator.

In the Voice mode, a total of 15 Banks (Preset Bank 1 – 8, User Bank 1 – 3, GM Bank, Preset Drum Bank, User Drum, GM Drum Bank) are available. Each of these Banks includes the Voices according to the Voice type. In the Voice Play display, you can select the desired Voice from various Voice Banks and play it.

NOTE For details about Voices, refer to "Basic Structure" on page 49. For a list of available Voices, refer to the Voice List in the separate Data List.

In the following section, we'll select and play some Voices. The example below assumes that you have connected an external MIDI keyboard to the MOTIF-RACK XS.

NOTE Make sure that the MIDI Transmit Channel of the external MIDI keyboard matches the MIDI Receive Channel of the MOTIF-RACK XS (page 21).

Selecting a Voice

1. Press the [VOICE] button.

This calls up the Voice Play display. (The [VOICE] button lamp lights.)

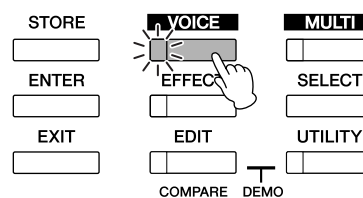

2. Select a Voice Bank with the Cursor [< / >] buttons.

In this condition, playing the external keyboard sounds the Voice indicated in the display. The parameters shown in the Voice Play mode are briefly explained below.

Voice Play display

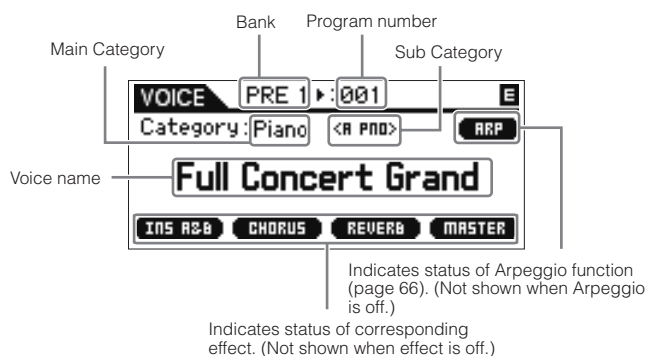

Normal Voice Banks

There are 12 different banks for the Normal Voices: PRE 1 – 8 (Preset Banks), GM (GM Bank), USR 1 – 3 (User Banks)

Drum Voice Banks

There are 3 different banks for the Drum Voices: PDR (Preset Drum Bank), GMDR (GM Drum Bank), UDR (User Drum Bank)

NOTE If the "Bank/Part Wrap" (page 99) of the Utility General window is set to "on," you can change from the last Bank to the first Bank continuously.

3. Select a Voice with the Encoder knob or Cursor [^]/[v] buttons.

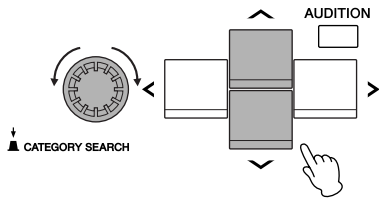

NOTE You can use the Encoder knob or Cursor [^]/[v] buttons to select the Voice number. This operation lets you call up Voices in subsequent or previous Banks.

NOTE To quickly move forward through the program (Voice) numbers in 10-step jumps, simultaneously hold down the Cursor [^] button and press the Cursor [v] button in the Play display. To do the same in reverse, use the opposite operation: simultaneously hold down the Cursor [v] button and press the Cursor [^] button.

TIP Selecting Voices by receiving MIDI messages

You can select Voices on this instrument from your DAW software by specifying the following MIDI messages. To do this, the following three MIDI messages must be transmitted to the MOTIF-RACK XS.

- Bank Select MSB (Control #0)
- Bank Select LSB (Control #32)
- Program Change

For example, transmit the following MIDI messages to select the Voice of program number 12 in the PRE2.

1. Transmit a Bank Select MSB (Control #0) value of 63.
2. Transmit a Bank Select LSB (Control #32) value of 1.
3. Transmit a Program Change value of 12*.

* If you are using a DAW software that has a Program Change value range of 0 to 127, transmit a Program Change value of 11 to the MOTIF-RACK XS.

For details on what values are assigned to the Voice Bank/Number of this tone generator, see the "MIDI Data Format" in the separate Data List. Also, for specific Program Change numbers and the corresponding Voices, refer to the separate Data List.

NOTE Set the MIDI Channel to the same channel as the "Receive Ch (Basic Receive Channel)" parameter (page 102).

NOTE When MIDI messages are received in the Voice mode, the [VOICE] button lamp flashes. This provides a quick way to check whether MIDI data is being received or not.

4. Play the connected keyboard.

The selected Voice sounds in response to the incoming MIDI data. Let's play some Voices here.

NOTE Keep in mind there is also an Audition function (page 16) that lets you listen to and audition each Voice as you select it.

Using the Category Search function

The MOTIF-RACK XS Voices are conveniently divided into some Categories, irrespective of their bank locations. The categories are divided based on the general instrument type or sound characteristics. The Category Search function gives you quick access to the sounds you want.

1. Press the Encoder knob in the Voice Play display.

The Category Search dialog appears.

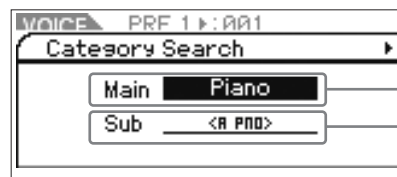

Main Category
Sub Category

NOTE Press [EXIT] to close the Category Search dialog.

2. Move the cursor position to "Main" (Main Category) with the Cursor [^] button, and turn the Encoder knob to select the Main Category.

3. Move the cursor position to "Sub" (Sub Category) with the Cursor [v] button, and turn the Encoder knob to select the Sub Category.

4. Press the [ENTER] button, Encoder knob, or Cursor [>] button to actually call up the Category.

The Voice List of the selected category is shown.

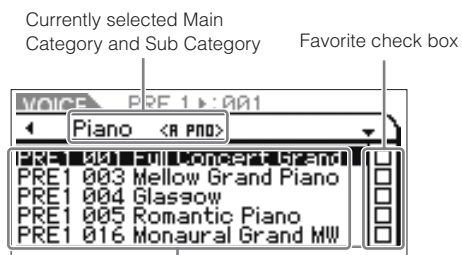

Voice list of currently selected category.

5. Select the Voice with the Cursor [^]/[v] buttons or Encoder knob.

If you want to change the Category, press the Cursor [<] button or [EXIT] button and go back to step 2.

6. Press the [ENTER] button or Encoder knob to actually call up the Voice.

This closes the Category Search dialog.

Grouping your most-used Voices together—Favorite Category

Category Search also has a convenient Favorite Category that lets you bring together your most often used and favorite Voices for easy selection. This is one more useful way you can quickly select the Voices you need from the huge number available on the instrument.

Registering your favorite Voices to the Favorite Category

1. Perform steps 1 through 4 of the “Using the Category Search Function” on page 28 to call up the Voice List of the selected Category.
2. Press the Cursor [>] button to move the cursor position to the Favorite check box column.
3. Press the Cursor [^]/[v] buttons or turn the Encoder knob to select the favorite Voice.
4. Press the [ENTER] button or Encoder knob to place a check in the Favorite check box.

The checkmark will be put to the box, and the selected Voice will be registered to the Favorite Category. To remove the checkmark from the box, press the [ENTER] button or Encoder knob again. To register other Voices, repeat steps 3 through 4.

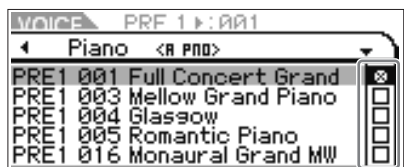

Favorite check box column

NOTE The Favorite Category is automatically stored immediately after checking the box.

5. When you complete registering Voices to the Favorite Category, press the [VOICE] button to return to the Voice Play display.

The Voice selected in the Category Search dialog is shown.

Selecting a Voice from the Favorite Category

1. Press the Encoder knob in the Voice Play display. The Category Search dialog appears.
2. Move the cursor position to “Main” (Main Category) with the Cursor [^] button, and turn the Encoder knob to set “Main” to “Favorite.”

NOTE When no Voice is registered to the Favorite Category, “Favorite” cannot be selected in the “Main” (Main Category) settings.

3. Press the [ENTER] button, Encoder knob, or cursor [>] button to actually call up the Favorite Category. The list of Voices registered to the Favorite Category will be shown.

Using Knobs 1 – 5 to change the sound

These let you adjust a variety of parameters for the current Voice, such as effect depth, attack/release characteristics, tonal color, and others. Four functions can be assigned to each knob, alternatively selected via the [SELECT] button. Each press of the button lets you switch among the function rows, with the currently enabled row indicated by the corresponding lamp at left.

Using Knobs 1 – 5

1. Press the [SELECT] button a few times so that the lamp corresponding to the desired functions lights.

The Knob Select pop-up window will appear. In the pop-up window, the function currently assigned to the Knob and the current value of the function are shown.

To close the pop-up window, press the [EXIT] button.

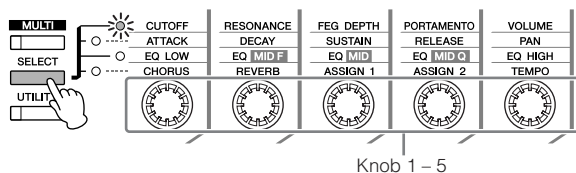

Knob 1 – 5



Functions assigned to Knob 1 – 5



Current values of the functions

NOTE When the “Knob Sel Disp Sw” is set to “off” in the Utility General window, the Knob Select pop-up window will not be shown.

NOTE When holding the [SELECT] button for two seconds or longer, Knobs 1 – 5 are assigned to the top functions.

2. Turn a desired Knob while playing the connected keyboard.

The Knob pop-up window will appear, and the function assigned to the Knob you’re currently operating will affect the sound of the current Voice. The Knob pop-up window shows the function assigned to the Knob you’re currently operating, the function value, and the “Original” value. The “Original” value indicates the unedited value (previously saved value) of the function assigned to the Knob.

Function of currently operated Knob Current value

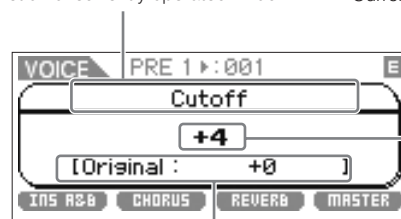

Unedited value (previously saved)

NOTE The “Knob Disp Time” (page 99) parameter of the Utility General window can be used to set the time that the Knob pop-up window remains displayed. When the “Knob Disp Time” is set to “off,” the pop-up window appears only when the Knob is pressed.

Functions of Knobs 1 – 5

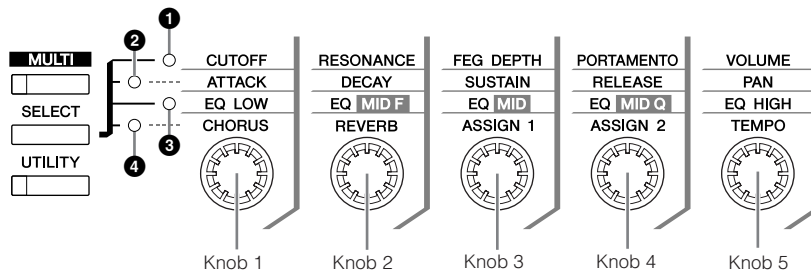

① When the 1st lamp is turned on:		Moving Knobs 1 and 2 changes the Filter parameters on the Filter display (pages 68, 83, and 96). Moving Knob 3 changes one of the FEG parameters on the EG display (pages 68 and 96). Moving Knobs 4 and 5 changes two of the parameters on the Play Mode display (pages 65, 83 and 94).
Knob 1	CUTOFF	Raises or lowers the Filter Cutoff Frequency (pages 68 and 96) to adjust the tone brilliance.
Knob 2	RESONANCE	Raises or lowers the Resonance (pages 68 and 96) to boost the level of the signal in the area of the cutoff frequency. By emphasizing the overtones in this area, this can produce a distinctive “peaky” tone, making the sound brighter and harder.
Knob 3	FEG DEPTH (Filter EG Depth)	Raises or lowers the Filter EG Depth (pages 68 and 96) to change the range of the cutoff frequency. When a Drum Voice is selected, this parameter cannot be set.
Knob 4	PORTAMENTO	Raises or lowers the Portamento Time (pages 65 and 95) to determine the pitch transition time or the speed of the pitch change when Portamento is applied. If you continue turning the knob toward the left, this parameter setting will turn “off” and set the “Porta Sw (Portamento Switch)” to “off.”
Knob 5	VOLUME	Sets the volume of the Voice (pages 65 and 94).
② When the 2nd lamp is turned on:		Moving Knobs 1 – 4 changes the AEG parameters on the EG display (pages 68, 83, and 96). Moving Knob 5 changes one of the parameters on the Play Mode display (pages 65, 83, and 94).
Knob 1	ATTACK (AEG Attack Time)	Increases or decreases the AEG Attack Time (pages 69 and 96) of the current Voice to adjust the attack rate. Positive values increasingly slow down the attack rate, while negative values speed it up.
Knob 2	DECAY (AEG Decay Time)	Increases or decreases the AEG Decay Time (pages 69 and 96) of the current Voice, controlling how fast the volume falls from maximum attack level to the sustain level. The smaller the value, the faster the decay.
Knob 3	SUSTAIN (AEG Sustain Level)	Increases or decreases the AEG Sustain Level (pages 69 and 96) at which the volume will continue while a key is held, after the initial attack and decay. When a Drum Voice is selected, this parameter cannot be set.
Knob 4	RELEASE (AEG Release Time)	Increases or decreases the AEG Release Time (pages 69 and 96) of the sound, controlling the time that the volume falls from the sustain level to zero when a Note Off message is received. When a Drum Voice is selected, this parameter cannot be set.
Knob 5	PAN	Adjusts the stereo pan position of the current Voice (pages 65 and 94).
③ When the 3rd lamp is turned on:		Moving Knobs 1 – 5 changes the parameters on the 3 Band EQ display (pages 71 and 83)/ Part EQ display (page 96).
Knob 1	EQ LOW (EQ Low Gain)	Increases or decreases the EQ Low Gain (pages 71 and 96) to change the sound.
Knob 2	EQ MID F (EQ Middle Frequency)	Increases or decreases the EQ Middle Frequency (pages 71 and 96) around which the band is adjusted via Knob 3 (EQ MID).
Knob 3	EQ MID (EQ Middle Gain)	Increases or decreases the EQ Middle Gain (pages 71 and 96) to change the current Voice.
Knob 4	EQ MID Q (EQ Middle Q)	Increases or decreases the EQ Middle Q (pages 71 and 97) to change the width of the band over which you can adjust the gain via Knob 3 (EQ Middle Gain). Turning Knob 4 clockwise increases the Q value to reduce the band width. Turning Knob 4 counter-clockwise decreases the Q value to widen the band width.
Knob 5	EQ HIGH (EQ High Gain)	Increases or decreases the EQ High Gain (pages 71 and 96) to change the current Voice.
④ When the 4th lamp is turned on:		Moving Knobs 1 and 2 changes parameters on the Effect display (pages 72 and 83)/ Fx Send display (page 97). Moving Knobs 3 and 4 changes parameters on the Control display (pages 71, 83, and 93). Moving Knob 5 changes one of the parameters on the Arp Edit display (page 66) or Arpeggio display (page 91).
Knob 1	CHORUS (Chorus Send)	Adjusts the Chorus Send Level (pages 72 and 83).
Knob 2	REVERB (Reverb Send)	Adjusts the Reverb Send Level (pages 72 and 83).
Knob 3	ASSIGN 1 (Assign 1 value)	A variety of functions can be assigned to these Knobs. Turning the Knob can edit the value of the function assigned to the Knob as offset. You can confirm the functions currently assigned to these Knobs in the Control display (pages 71 and 93) in the Voice Common Edit / Multi Common Edit.
Knob 4	ASSIGN 2 (Assign 2 value)	
Knob 5	TEMPO (Arpeggio Tempo)	Adjusts the tempo for the Arpeggio playback (pages 66 and 91).

NOTE Operating the knobs may have little to no effect on certain voices.

NOTE The Multi mode features the same parameter-to-knob assignments as the Voice mode.

The Indicator

When changing the value of the parameter in the Voice/Multi Play or Edit display, the  (Edit) Indicator will appear on the top right corner of the LCD. This gives a quick confirmation that the current Voice/Multi has been modified but not yet stored. To store the current edited status, follow the instructions on page 46.

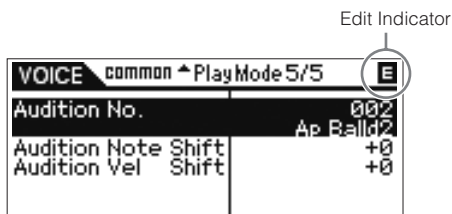

NOTE For certain Arpeggio types or Audition Phrase types, playing the MOTIF-RACK XS sound will show the  (Edit) Indicator.

Voice Editing

“Editing” refers to the process of creating a Voice by changing the parameters that make up the Voice. This can be done in Voice Edit, a sub mode within the Voice mode.

The actual parameters that are available differ depending on the Voice type.

Normal Voice Edit

A Normal Voice (pitched musical instrument-type sounds) can consist of up to eight Elements. There are two types of Voice Edit displays: Common Edit, for editing the settings common to all eight Elements; and Element Edit, for editing individual Elements. In Element Edit, you can edit the parameters only on the MOTIF-RACK XS Editor.

Drum Voice Edit

There are two types of Drum Voice Edit displays: Common Edit, for editing the settings that apply to all Drum keys in the Voice; and Key Edit, for editing individual keys. In Key Edit, you can edit the parameters only on the MOTIF-RACK XS Editor.



About Elements

An Element is the basic and the smallest unit for a Voice, and is created by applying various parameters (Effect, EG, etc.) to the waveform of the instrument sound. Each Voice of the MOTIF-RACK XS consists of several Elements.

TIP Compare Function

When you're editing a Voice or Multi, this feature lets you quickly and easily hear the effect of the edits you make—allowing you to switch between the original, unedited Voice/Multi and the newly edited settings.

1. In the Edit mode (with the  indicator shown in the display and the [EDIT] button lamp lit), press the [EDIT] button.

The [EDIT] button lamp will flash, and the  (Compare) indicator is shown at the top of the display (in place of the  (Edit) indicator), and the original, unedited Voice is restored for monitoring.

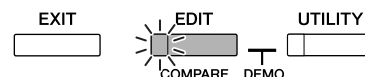

Compare Indicator

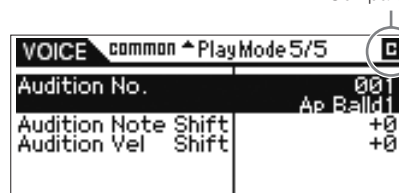

2. Press the [EDIT] button again to disable the Compare function.

This returns the Voice to its current edited condition. (The  indicator is shown in the display and the [EDIT] button lamp lights.) Compare the edited sound with the unedited sound as desired by repeating steps 1 and 2.

NOTE The Compare function is also available in the Multi Edit mode.

NOTE While Compare is active, you cannot make edits to the parameters.

Normal Voice Edit/ Drum Voice Edit

1. Press the [VOICE] button to show the Voice Play display, then select a Voice to be edited (page 27).
2. Press the [EDIT] button to enter the Common Edit mode.

The Voice Edit Select display appears.

Indicates that Common Edit is selected.



Names of the selectable Edit displays are shown.

3. Move the cursor position to the desired Edit display with the Cursor [^]/[v]/[<]/[>] buttons or Encoder knob.

4. Press the [ENTER] button or Encoder knob to call up the desired Edit display.

The selected Edit display appears.

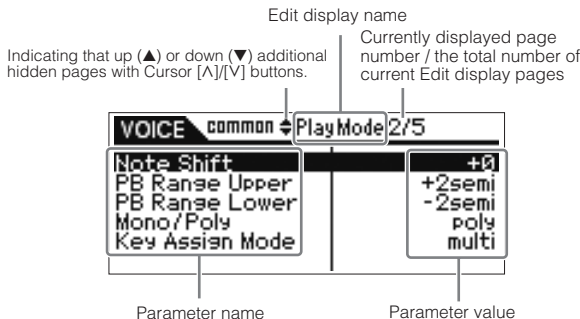

5. Press the Cursor [^]/[v] buttons to select the desired parameter.

For details about each parameter, refer to the Reference section (page 64).

NOTE On the Edit display, simultaneously holding down the Cursor [v] button and pressing the Cursor [^] button selects the first parameter on the previous page, while holding down the Cursor [^] button and pressing the Cursor [v] button selects the first parameter on the next page.

6. Turn the Encoder knob to change the Parameter settings.

7. Repeat steps 3 – 6 as desired.

8. Name the edited Voice.

Input the desired name in the "Name" parameter in the Name display of Common Edit. For detailed instructions on naming, see page 47.

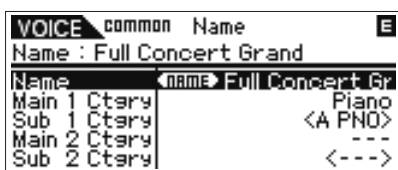

9. Press the [STORE] to store the edited Voice.

For details about storing the Voice, see page 46.

NOTE When you press the [EDIT] button in the Store display, you can check the sound of the Voice at the storing destination by playing the connected keyboard or playing the Audition Phrase (Store Compare function).

CAUTION

The edited Voice will be lost when selecting a different Voice or turning the power off. Make sure to store the Voice data to the internal memory by pressing the [STORE] button before selecting a different Voice or turning the power off.

NOTE If desired, save the edited and stored Voices to the MOTIF-RACK XS Editor on a computer connected to the MOTIF-RACK XS. Keep in mind that edited Voice data is stored to internal User memory (Flash ROM) and is maintained even when turning the power off. As such it is not necessary to save the data to an external device; however, we still recommend that you save or archive all important data to an external device. For details, see page 47.

Editing the Elements/ Drum Keys on the MOTIF-RACK XS Editor

If you want to do detailed editing of the Elements/ Drum Keys of the MOTIF-RACK XS, you can do that on the MOTIF-RACK XS Editor. Included in the Element/ Drum Key settings are Oscillator, Pitch, Filter, Amplitude, and EG (Envelope Generator), and other parameters. For a complete list of the parameters, refer to Element Edit (page 73) and Key Edit (page 84) in the Reference section.

When both the MOTIF-RACK XS data and the MOTIF-RACK XS Editor are synchronized, the settings in the MOTIF-RACK XS Editor will be reflected to the same as in the MOTIF-RACK XS. For details about how to connect the MOTIF-RACK XS to the MOTIF-RACK XS Editor, refer to the section "Using the MOTIF-RACK XS Editor" (page 23).

TIP Assigning drum/percussion instruments to individual keys

In the Drum Key Edit mode on the MOTIF-RACK XS Editor, you can create your own original drum kits by assigning specific instrument sounds to individual keys (in any desired order) and edit detailed parameters for each key's sound. For detailed instructions, refer to the Owner's Manual of the MOTIF-RACK XS Editor via the Help menu in the program.

TIP Setting the drum key for independent open and closed hi-hat sounds

In a real drum kit, some drum sounds cannot physically be played simultaneously, such as open and closed hi-hats. You can prevent different drum instruments from playing back simultaneously by assigning them to the same Alternate Group (page 84).

The preset Drum Voices have many such Alternate Group assignments to ensure the most authentic, natural sound. When creating a Voice from scratch, you can use this feature on the MOTIF-RACK XS Editor—either to ensure authentic sound, or to create special effects, where playing one sound cancels out a previous one. For detailed instructions, refer to the Owner's Manual of the MOTIF-RACK XS Editor via the Help menu in the program.

TIP Determining how the Drum Voice responds when the key is released

You can determine whether or not the selected Drum key responds to MIDI Note Off messages in the Drum Key Edit on the MOTIF-RACK XS Editor. Setting the "Receive Note Off" parameter (page 84) to "off" can be useful for cymbal sounds and other sustaining sounds. This lets you have the selected sounds sustain to the length of their natural decay even if you release the note, or when a Note Off message is received. If this parameter is set to "on," the sound will stop immediately when a Note Off message is received.

TIP Setting the Output destination for each key

You can change the output destination for the individual Drum key signal in the Drum Key Edit on the MOTIF-RACK XS Editor. This function is useful when you wish to apply a connected external effect to a specific drum instrument. For details, see the section "Output Select" (page 85) in Key Edit of the Reference section.

NOTE The "Output Select" parameter is available only when the "Ins Effect Output (Insertion Effect Output)" parameter is set to "thru" in the OSC (Oscillator) section on the MOTIF-RACK XS Editor.

Using Voice Effects

In the final stages of programming, you can set effects parameters to further change the sound's character. In the Voice Mode, you can set up and store effects with each Voice. For details on the structure of the effects, see the Effect Block in the Basic Structure (page 57). For details on the effect parameters, see the Effect display of the Voice mode in the Reference section (page 72).

Here we'll show an example how to edit effect settings.

1. Select the Voice you wish to edit (page 27).
2. Press the [EDIT] button, move the cursor position to the "Effect" in the Voice Edit Select display, then press the [ENTER] button.

The Effect display in the Voice Common Edit appears.

NOTE Holding the [EFFECT] button for two seconds or more also calls up the Effect display in the current mode.

The selected parameter name and value are shown.

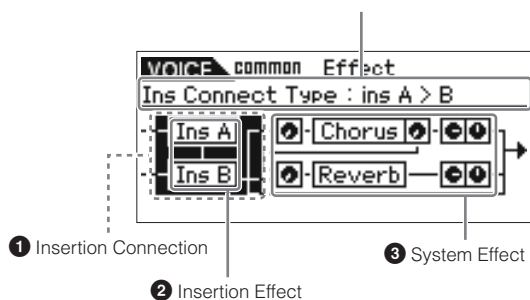

① Insertion Connection

Determine the effect routing for Insertion Effects A and B.

② Insertion Effect

Indicates the currently selected effect type of Insertion Effect A or B. When the cursor is located at "Ins A" / "Ins B," pressing the [ENTER] button or the Encoder knob calls up the Effect Parameters display, letting you set the effect type or effect parameters.

③ System Effect (Chorus/ Reverb)

Indicates the currently selected effect types of the System Effect (Chorus/ Reverb), and Set the Send levels and Return levels. When the cursor is located at "Chorus" / "Reverb," pressing the [ENTER] button or the Encoder knob calls up the Effect Parameters display, letting you set the effect type or effect parameters.

3. Move the cursor position to "Ins A"/"Ins B" with the Cursor [^]/[v]/[<]/[>] buttons, then press the [ENTER] button.

The Effect Parameters display (page 72) will appear. In the display, you can set the Insertion Effect types or parameters.

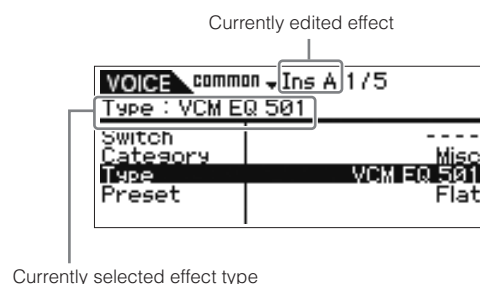

Currently selected effect type

4. Move the cursor position to the effect type parameter or the effect parameters with the Cursor [^]/[v] buttons, then turn the Encoder knob to change each of the parameter settings.

NOTE For details about effect categories, effect types, and effect parameters, refer to the section "Basic Structure" on page 59 or the effect related list in the separate Data List

5. Press the [EXIT] button to return to the Effect display.

6. Move the cursor position to the Insertion Connection with the Cursor [^]/[v]/[<]/[>] buttons, then turn the Encoder knob to determine the effect routing for Insertion Effects A and B.

7. As necessary, set the "Element Out" (page 72)/"Key Out" (page 83) parameters in the Effect display on the MOTIF-RACK XS Editor.

The "Element Out" parameter determines whether the signals for each individual Element 1 – 8 are sent to Insertion Effect (A or B) or if they bypass the Insertion Effect. The "Key Out" parameter determines whether the signals for each individual Drum Key are sent to Insertion Effect (A or B) or if they bypass the Insertion Effect.

8. Move the cursor position to the "Chorus"/"Reverb" with the Cursor [^]/[v]/[<]/[>] buttons, then press the [ENTER] button.

This calls up the relevant effect parameters display (page 72). In the display, set the System Effect (Chorus/Reverb).

9. Move the cursor position to the effect type parameter or effect parameters, then turn the Encoder knob to change each parameter setting.

NOTE For details about effect categories, effect types, and effect parameters, refer to the section "Basic Structure" on page 59 or the effect related list in the separate Data List.

10. Press the [EXIT] button to return to the Effect display.

11. Move the cursor position to Send level, Return level, or Pan, then turn the Encoder knob to set the levels.

NOTE For Drum Voices, the "Chorus Send (Key Chorus Send)" / "Reverb Send (Key Reverb Send)" parameters (page 84) or the "Chorus Ins Send (Insertion Chorus Send)" / "Reverb Ins Send (Reverb Insertion Send)" parameters (page 84) on the MOTIF-RACK XS Editor determine the Send levels for each Key of the current Drum Voice.

12. Press the [STORE] button to store the Voice.

The Effect parameters in the Voice mode can be set for each Voice. If you wish to save the new settings, store the settings with the other Voice parameters as a single Voice before you leave the selected Voice (page 46).

NOTE When you press the [EDIT] button in the Store display, you can check the sound of the Voice at the storing destination by playing the connected keyboard or playing the Audition Phrase (Store Compare function).

CAUTION

If you call up another Voice or another mode without storing, the edited settings may be lost.

13. If desired, set the Master Effect or the Master EQ.

These settings are found in the Utility Voice MEF window (page 102) or Utility Voice MEQ window (page 103). To call up these displays, use this procedure:

Voice mode → [UTILITY] → select "Voice MEF"/"Voice MEQ" → [ENTER]

For details on the structure of the effects, refer to Effect Block of the "Basic Structure" on page 57.

14. Press the [STORE] button to store the edited Voice.

When you execute this store operation in the Utility Voice MEF window / Utility Voice MEQ window, the entire system settings including the MEF/MEQ settings are stored.

To go back to the original display in the Voice mode, press the [EXIT] button twice.

CAUTION

If the power is turned off without storing, the edited settings may be lost.

Switching the Effect on/off

From the Effect dialog (called up by pressing the [EFFECT] button), you can switch the Insertion Effects, System Effects (Chorus / Reverb), and Master Effect on or off.

These Effect settings are temporary and will reset to "on" when the power is switched off. Also, these settings are applied to all Voices/ Multis.

As for the Master Effect setting in this dialog, it is linked with the Master Effect Switch in the Voice mode / Multi mode.

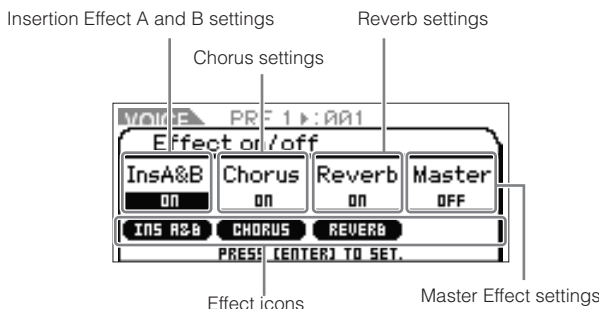

When each Effect parameter is set to "on," the corresponding Effects are enabled and the Effect icons are shown. When each Effect parameter is set to "off," the corresponding Effects are disabled and the Effect icons are off.

NOTE The Master Effect Switch can also be set via the "Switch" parameter of the Utility Voice MEF window (page 103) in the Voice mode or the "Switch" parameter of the Master Effect parameters display (page 93) in Multi Common Edit.

NOTE Even if the "Ins Effect Sw (Insertion Effect Switch)" in Multi Part Edit is set to "on" (page 97), setting the "Ins A&B" to "off" in the Effect dialog will disable the Insertion Effect of the selected Multi.

NOTE When selecting the Voice/Multi which Effects in the Effect dialog are set to on for all units, the lamp of the [EFFECT] button will light.

NOTE Holding the [EFFECT] button for two seconds or more calls up the Effect display in Common Edit.

Multi Mode

The Multi mode lets you set up the MOTIF-RACK XS as a multi-timbral tone generator for use with computer-based music software or external sequencers. If each track in a song file uses a different MIDI channel, you can independently assign each of the Parts in a Multi to those MIDI channels. In this way, you can play back the song data on a sequencer with each track playing a different Voice. You can create a Multi containing up to 16 Parts using the internal tone generator. Since there is only one bank for Multi, you need not select a Multi Bank.

NOTE About the User Bank of Multis

When shipped from the factory, this tone generator contains a full set of specially programmed 128 User Multis in the User Bank. If a Multi in a User Bank is overwritten, the User Multi will be lost. When you store the edited Multi, be careful not to overwrite any important User Multis.

Playing a Multi

From the Multi Play display in the Multi mode, you can select and play any of the Multis. For more details about Multis, see page 25. Here, you'll learn how to play back song files of the DAW software on your computer with the MOTIF-RACK XS.

1. **Connect the MOTIF-RACK XS to the computer following the instructions on page 17.**
2. **On the computer, start the DAW software, then open the new file.**

Set the MIDI related settings such as MIDI port and MIDI transmit channel for each track by following the instructions on page 22.

MIDI port

If you are using the internal tone generator of the MOTIF-RACK XS, set the MIDI port for each track of the DAW software to "1."

MIDI channel

Match the MIDI transmit channels of the DAW software with the receive channels of the Multi Parts. The receive channels of the Multi can be set in the Voice display of the Multi Part Edit mode (page 94).

For details, refer to the manual of your DAW software.

3. **On the MOTIF-RACK XS, press the [MULTI] button to enter the Multi mode.**

The lamp of the [MULTI] button lights.

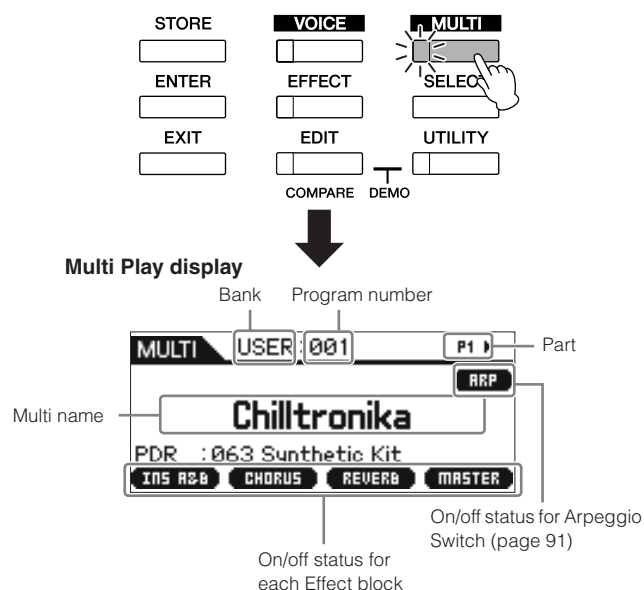

4. **Select a Multi with the Cursor [▲]/[▼] buttons and Encoder knob, then set the desired parameters for each Part.**

Assign the various settings to each Part, such as the desired Voice, appropriate MIDI Receive Channels, and Effects for optimum playback of the song. For more information, refer to page 36.

NOTE When shipped from the factory, the MOTIF-RACK XS contains a full set of specially programmed 128 User Multis in the User Bank. If you wish to initialize all settings for a selected Multi, press the [ENTER] button while holding the [MULTI] button.

NOTE You can increase the program number by 10 by simultaneously holding down the [▲] button and pressing the [V] button. To decrease by 10, do the opposite; simultaneously hold down the [▼] button and press the [▲] button.

5. **Record your song data to the DAW software.**

For details, refer to the owner's manual of your DAW software.

6. Play back the song file on the DAW software to play the sounds of the MOTIF-RACK XS.

When a Note On message is received, the corresponding Part is played. For example, when you play back tracks on the sequencer, the Part whose Receive Channel is same as the DAW software track's Transmit Channel is played. If two or more Parts have the same MIDI receive channel value, those Parts will play in unison. For details about the channel settings, see page 21.

Multi mode

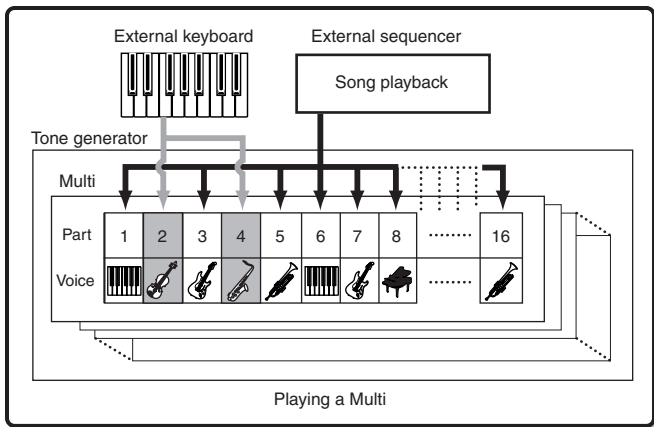

Change the sound of the current Multi by using Knobs 1 – 5

You can change the sound of the current Multi by using Knobs 1 – 5 on the front panel. These knobs are assigned to control parameters common to all Multi Parts. For information on operating these knobs and assigned functions, refer to explanations (page 29) about the Voice mode.

Editing the Multi

The Multi Edit functions consist of Common Edit and Part Edit. Common Edit lets you edit the parameters common to all the Parts while Part Edit lets you edit the parameters for each of the Parts.

1. Press the [MULTI] button to enter the Multi mode, then select the desired Multi (page 35).

If you are creating a Multi from scratch, use the convenient Initialize function. Pressing the [ENTER] button while holding the [MULTI] button initializes all settings for the selected Multi. Initializing the selected Multi can also be performed from the MOTIF-RACK XS Editor. For information about data communication between MOTIF-RACK XS Editor and this instrument, see page 23. For instructions about the Initialize function, refer to the manual of the MOTIF-RACK XS Editor.

2. Press the [EDIT] button to enter the Multi Edit mode.

The Multi Edit Select display appears.

3. Select “Common” or one of the “1” – “16” settings with the Cursor [^]/[v]/[<]/[>] buttons and Encoder knob.

Select “Common” when you want to edit the Common parameters. Select the desired number from “1” – “16” when you want to edit the individual Part parameters.

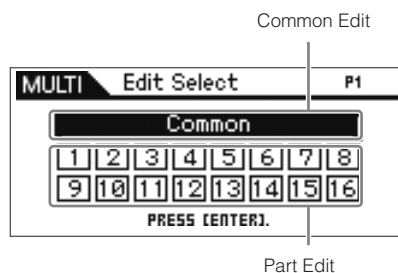

4. Press the [ENTER] button or the Encoder knob.

The Common Edit Select display or the Part Edit Select display appears.

5. Select a menu with the Cursor [^]/[v]/[<]/[>] buttons and the Encoder knob.

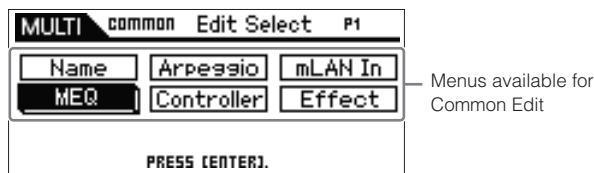

Common Edit Select display

Indicates the currently selected Part

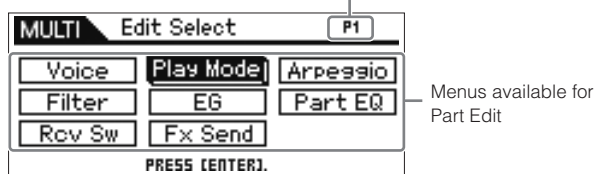

Part Edit Select display

6. Press the [ENTER] button or Encoder knob to select the particular Edit display.

The Edit display of the selected menu will appear.

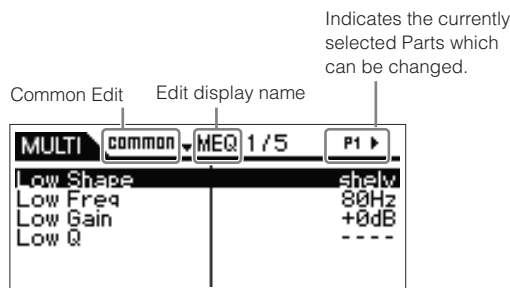

Example: MEQ display of Common Edit

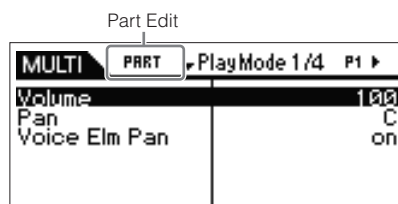

Example: Play Mode display of Part Edit

7. Select the desired parameter with the Cursor [\wedge]/[\vee] buttons.

For details about each parameter, refer to the Reference section (page 91).

NOTE On the Edit display, holding the [\vee] button then pressing the [\wedge] button moves the cursor to the parameter at the top of the next page, while holding the [\wedge] button then pressing the [\vee] button moves the cursor to the parameter at the top of the previous page.

8. Edit the value of the selected parameter by turning the Encoder knob.

TIP Assigning a Voice to each Part

In Part Edit:

Call up the Voice display (page 94) of the desired Part (this operation corresponds to steps 3 – 6), then select a Bank and Voice number in the Voice display (this operation corresponds to steps 7 – 8).

By using the Category Search function:

The Category Search function is available in the Multi mode as well as in the Voice mode via the following two methods.

- [MULTI] → select any Part → press the Encoder knob to call up the Category Search dialog
- [MULTI] → [EDIT] → select any Part → [ENTER] → select "Voice" → [ENTER] → press the Encoder knob to call up the Category Search dialog

For information about how to set the Category Search dialog, refer to explanations of the Voice mode (page 28).

By using MIDI messages:

You can select a Voice by transmitting the appropriate MIDI messages from the external DAW software. Transmitting the Bank Select MSB, Bank Select LSB and Program Change messages to the MOTIF-RACK XS will change the Voice of the Part of which the MIDI Receive channel is same as that of the Transmit Channel.

NOTE The Transmit Channel of the Bank Select MSB, Bank Select LSB and Program Change messages should be set to the value same as the MIDI Receive Channel for the desired Part.

NOTE The lamp of the [MULTI] button flashes while the MIDI messages are received in the Multi mode.

9. If the MOTIF-RACK XS is in Multi Part Edit, change the Part by using the [\leftarrow]/[\rightarrow] buttons, then edit the parameters.

NOTE When the "Bank/Part Wrap" parameter (page 99) is set to "on" in the Utility General display, you can select the Part values continuously in "wrap around" fashion, backwards or forwards, when using the Cursor [\leftarrow]/[\rightarrow] buttons.

10. Set the Effect related parameters.

For details, see the next section, "Effect setting in the Multi mode."

11. Repeat steps 3 – 10 as desired.

12. Assign a name to the edited Multi.

You can assign a name to the edited Multi in the Name display of the Common Edit. For instructions on naming, see page 47.

13. Press the [STORE] button to store the edited Multi.

Up to 128 User Multis can be stored in the User Memory. For instructions on storing, see page 46.

NOTE From the Multi Store window, you can check the sound of the Multi specified as destination by pressing the [EDIT] button in the window. Use this function named "Store Compare" before executing the Store operation.

CAUTION

The edited Multi will be lost when selecting a different Multi or turning the power off. Make sure to store the Multi data to the internal memory by pressing the [STORE] button before selecting a different Multi or turning the power off.

CAUTION

When you execute the Store operation, the settings for the destination memory will be overwritten. Important data should always be backed up to the MOTIF-RACK XS Editor on a computer connected to the MOTIF-RACK XS.

Effect settings in the Multi mode

In the final stages of programming and creating sounds, you can use effects to further enhance and change the character of the sound — such as by applying a deep, ambient reverb, or by using chorus to make certain sounds richer and more animated. When you edit Multi Effect parameters, keep in mind that there are two different types:

Parameters specific to individual Parts (in Multi Part Edit)

- A** Part EQ
- B** Insertion Effect Switch on/off and Send Level/Dry Level settings for System Effects

Parameters common to all Parts (in Multi Common Edit)

- C** System Effect settings such as Effect Type and Return Level
- D** Master Effect
- E** Master EQ

Effect setting flow in the Multi mode

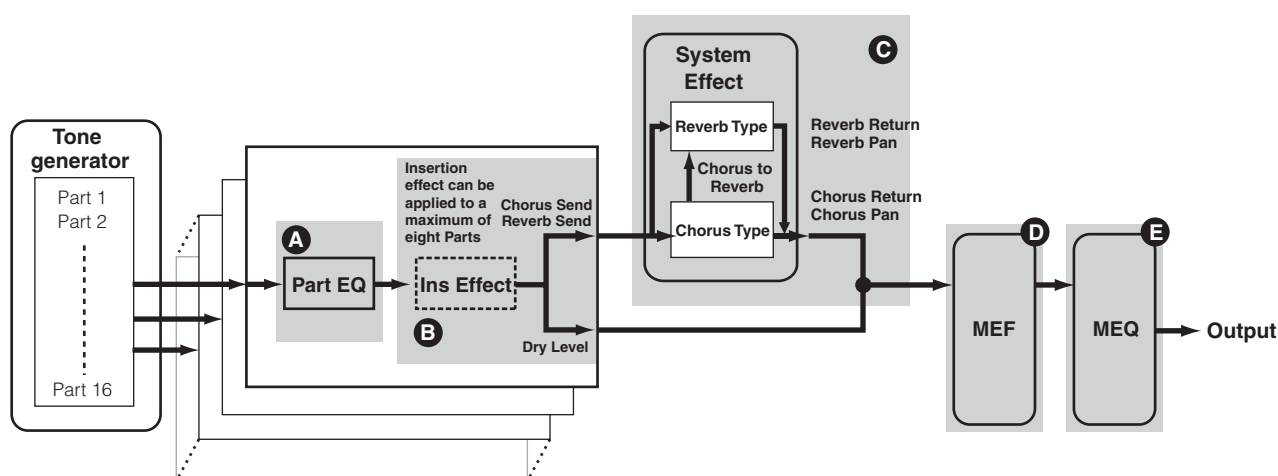

NOTE The audio signals of the Parts for which the “Output Select” parameter (page 96) is set to something other than “L&R” can be applied at only “Part EQ” and “Ins Effect (Insertion Effect)” as shown above and output. The signals are not applied at the effect settings after “Chorus Send”/ “Reverb Send”/ “Dry Level” in the signal flow.

Below is an example of editing effect settings in the Multi Mode.

1. Select the desired Multi for editing in the Multi mode (page 35).
2. Press the [EDIT] button to enter the Multi Edit mode. The Multi Edit Select display appears.
3. Choose a Part to which you want to apply the Insertion Effect with the Cursor [\wedge]/[\vee]/[<]/[>] buttons and Encoder knob, then press the [ENTER] button to actually select the Part for editing. The Part Edit Select display appears.
4. Select “Fx Send” by using the Cursor [\wedge]/[\vee]/[<]/[>] buttons and Encoder knob, then press the [ENTER] button. The Fx Send display appears.
5. Move the cursor position to “Ins Effect Sw,” then set the value to on by turning the Encoder knob \odot . If desired, select a different Part by using the Cursor [<]/[>] buttons, then set this parameter likewise. By setting the Ins Effect Sw parameter to on, you can apply the Insertion Effect which is set to the Voice of the current Part to the currently edited Part. Note that this parameter can be set to on for up to eight Parts simultaneously.

MULTI	PART	Effect Send	P2	▶	E
Chorus Send			12		
Reverb Send			0		
Dry Level			127		
Ins Effect Sw			on		

6. In the same display, move the cursor position to “Chorus Send,” “Reverb Send” and “Dry Level,” then set the values by turning the Encoder knob **Ⓔ**.

You can adjust the Chorus Send Level, Reverb Send Level and Dry Level for the currently selected Part.

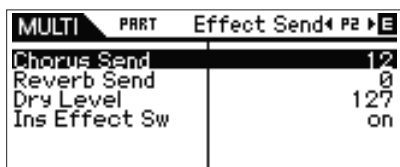

NOTE Setting Reverb Send and Chorus Send to values of 0 will result in no Reverb/Chorus being applied to the current Part.

7. Press the [EXIT] button twice to return to the Multi Edit Select display.

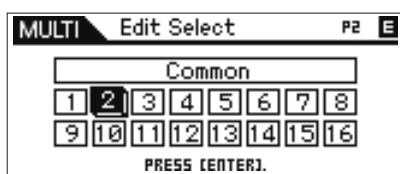

8. Select “Common” by using the Cursor [**^**]/[**V**]/[**<**]/[**>**] buttons and Encoder knob, then press the [ENTER] button.

The Common Edit display appears.

9. Select “Effect” by using the Cursor [**^**]/[**V**]/[**<**]/[**>**] buttons and Encoder knob, then press the [ENTER] button.

The Effect display appears.

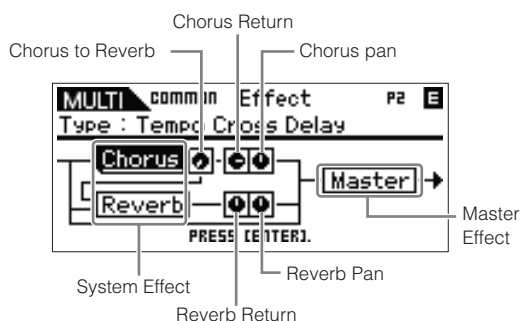

10. Move the cursor position to “Chorus” or “Reverb” by using the Cursor buttons, press the [ENTER] button, then set the parameters.

In the Reverb or Chorus displays, you can set the System Effect (to which Reverb/Chorus belong) parameters, such as Effect type and detailed Effect parameters.

NOTE For details about the Effect categories, types and parameters, refer to page 59 and the Effect related list in the separate Data List booklet.

11. Press the [EXIT] button to return to the Effect display.

12. Move the cursor position to “Chorus Return,” “Chorus Pan,” “Reverb Return,” “Reverb Pan” or “Chorus to Reverb” by using the Cursor buttons, then set the value by turning the Encoder knob **Ⓔ**.

These parameters determine the depth or degree with which the Effect is applied.

13. Move the cursor position to “Master,” press the [ENTER] button, then set the related parameters.

In the Master Effect (MEF) display (page 93), you can edit the parameters for the Master Effect common to all Parts.

14. Set the parameters related to the Master EQ (MEQ) and Part EQ **Ⓐ** **Ⓑ**.

When setting the Master EQ, press the [EXIT] button a few times to return to the Multi Common Edit Select display, select “MEQ,” then press the [ENTER] button to call up the MEQ display (page 92). When setting the Part EQ, press the [EXIT] button a few times to return to the Multi Edit Select display, select any Part from 1 – 16, press the [ENTER] button, select “Part EQ,” then press the [ENTER] button to call up the Part EQ display (page 96).

15. Press the [STORE] button to store the edited Multi.

The Effect related settings can be stored as a Multi. For instructions on storing, see page 46.

NOTE From the Multi Store window, you can hear the sound of the Multi specified as destination by pressing the [EDIT] button in the window. Use this function named “Store Compare” before executing the Store operation.

CAUTION

The edited Multi including the Effect settings will be lost when selecting a different Multi or turning the power off. Make sure to store the Multi data to the internal memory by pressing the [STORE] button before selecting a different Multi or turning the power off.

CAUTION

When you execute the Store operation, the settings for the destination memory will be overwritten. Important data should always be backed up to the MOTIF-RACK XS Editor on a computer connected to the MOTIF-RACK XS.

Playing four Parts in a layer with a single MIDI keyboard

In the Multi mode, you can set so that four Voices (Parts) can sound simultaneously by receiving the MIDI messages for a single MIDI channel from an external MIDI keyboard or computer (DAW software).

The settings for the Parts 1 – 4 of a preset Multi can be made to create a thick, richly textured sound and Arpeggio playback (rhythm pattern, etc.) simply by playing a single MIDI keyboard (over a single MIDI channel), and serve as inspiration for song creation and music performance.

Here, we'll show you how to play the four Voices (Parts) simply by using a single MIDI keyboard. After connecting the MIDI keyboard to the MOTIF-RACK XS via MIDI, follow the instructions below.

1. Press the [UTILITY] button to enter the Utility mode.
The Utility Select window appears.

2. Select "General" by using the Cursor [^]/[v]/[<]/[>] buttons or the Encoder knob, then press the [ENTER] button or the Encoder knob.
The Utility General display appears.

3. Move the cursor position to "Layer 1-4 Parts" (page 98) in the second page by using the Cursor [^]/[v]/[<]/[>] buttons, then set the value to "on" by turning the Encoder knob.

When this parameter is set to on, the Parts 1 – 4 of the current Multi will handle only the MIDI messages of the MIDI channel set to the same value as specified in the "Receive Ch (Basic Receive Channel)" parameter (page 102) in the Utility parameters of the Voice mode, regardless of the MIDI Receive channel setting for each Part.

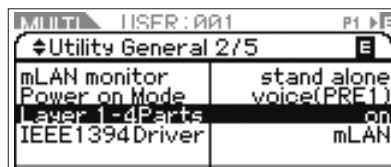

NOTE The MIDI channel settings for the Multi Parts 1 – 4 will be maintained regardless of the "Layer 1-4 Parts" parameter setting. These settings are available only when the "Layer 1-4 Parts" parameter is set to "off."

NOTE If you have changed the MIDI related parameters from the initial factory settings, make sure to set the "Receive Ch" parameters (page 94) for Parts 5 – 16 to values different from the value of the Receive Ch parameter (page 102) in the Utility mode before setting the Layer 1 – 4 Parts parameter.

4. Press the [MULTI] button to call up the Multi Play display, then select a Multi by using the Cursor [^]/[v] buttons or the Encoder knob.
5. On the external MIDI keyboard, set the MIDI Transmit Channel (via the keyboard performance) to the value same as the setting of the Receive Ch parameter (page 102) in the Utility parameters of the Voice mode of the MOTIF-RACK XS.
6. Play a note on the keyboard connected to the MOTIF-RACK XS.

Simply pressing a single note will play the four Voices simultaneously and may trigger Arpeggio playback depending on the Multi settings.

NOTE When a computer is connected to the MOTIF-RACK XS and the MOTIF-RACK XS Editor has been installed, you can try the additional Multi programs provided in the MOTIF-RACK XS Editor. On the MOTIF-RACK XS Editor, the 384 (128 x 3 banks) Multi programs are provided. In the online status between the MOTIF-RACK XS Editor and instrument, select a Multi which is not included in the MOTIF-RACK XS on the MOTIF-RACK XS Editor then try playing the keyboard.

Using the Arpeggio Function

What is the Arpeggio function?

This function automatically triggers preset arpeggio phrases, riffs, and rhythmic patterns according to the notes you play. It not only provides inspiration and full rhythmic passages over which you can perform, it gives you quality MIDI data you can use in creating songs, or fully formed backing parts to be used in your live performances. You can assign the desired five Arpeggio Types to each Voice. You can also set the Arpeggio playback method, Velocity range and Play Effects to create your own original grooves. What's more, Arpeggio playback can be transmitted through the MIDI Out, letting you record the Arpeggio data to the external MIDI sequencer or the DAW software on your computer.

TIP Transmitting Arpeggio playback as MIDI data

If you want to use the Arpeggios to trigger other MIDI tone generators or record the MIDI data of Arpeggios to the external MIDI sequencer or the DAW software on your computer for further editing, you can have the Arpeggio playback data transmitted as MIDI data via the USB, mLAN, or MIDI OUT terminal. This is done by setting the following switch parameters to "on":

Voice Arpeggio: Voice mode → [UTILITY] → select "Voice MIDI" → [ENTER] → "Arp MIDI Out Sw"

Multi Arpeggio: Multi mode → [EDIT] → select any Part → [ENTER] → select "Arpeggio" → [ENTER] → select "Arp Edit" → [ENTER] → "Arp MIDI Out Sw"

Arpeggio structure

The following illustration indicates the data structure of the Arpeggio.

Up to five Arpeggio types can be assigned to each Voice or each Part of a each Part of a Multi.

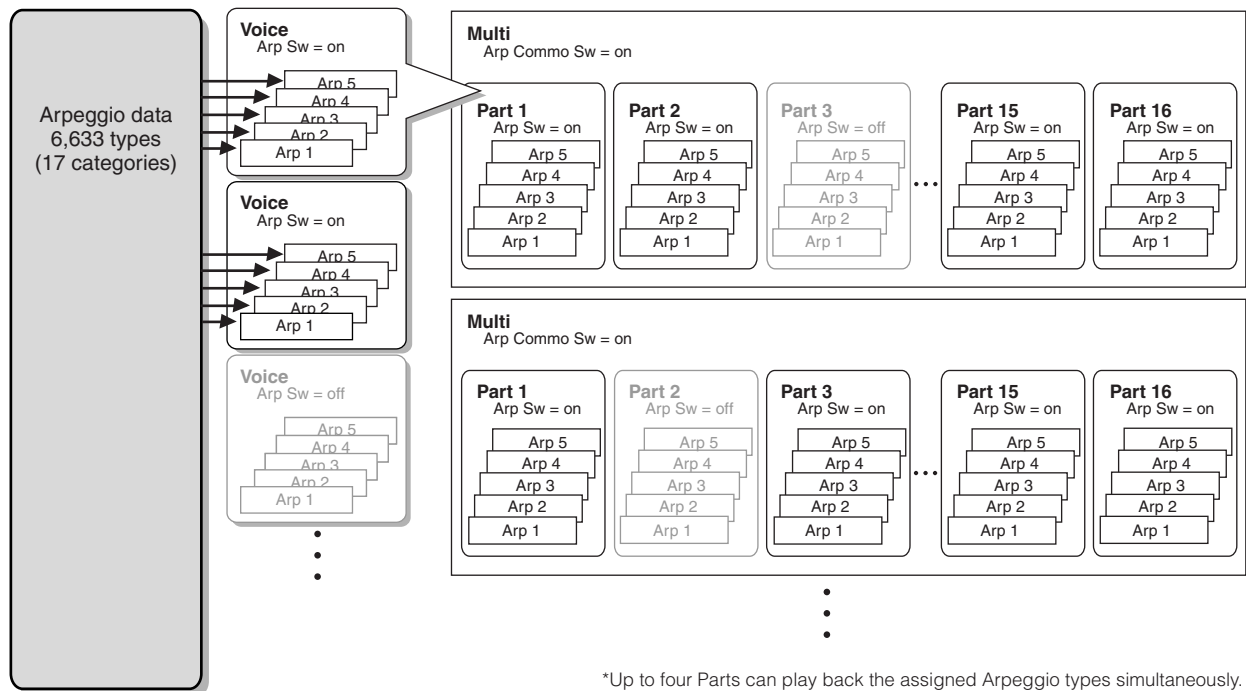

Arpeggio types

The MOTIF-RACK XS features 6,633 Arpeggio types (in 17 categories) including Synthesizer, Piano, Guitar, Bass, Strings, Drum, etc. For details, see the Arpeggio Block in the Basic Structure on page 53.

Arpeggio playback

Arpeggio playback in the Voice mode

The Arpeggio can be played back only when the MOTIF-RACK XS receives Note On messages from an external MIDI device or DAW software. After connecting the MIDI keyboard to the MOTIF-RACK XS, follow the instructions below to play the Arpeggio.

1. Set the “Audition Button” parameter to “arpeggio sw” (page 99) in the Utility General window (called up via [UTILITY] → select “General” → [ENTER]).
2. Press the [VOICE] button to enter the Voice mode, then select the desired Voice in the Voice Play display.
3. Press the [AUDITION] button so that the lamp lights. This operation enables the Arpeggio function.

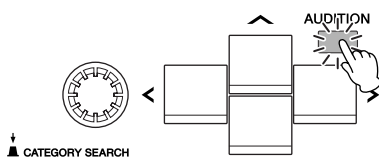

NOTE If the “Arp Sw” parameter of the Voice has been already set to on, the lamp of the [AUDITION] button lights immediately when the Voice is selected.

4. Play the external MIDI keyboard connected to the MOTIF-RACK XS.

How the Arpeggio playback responds to incoming notes may differ depending on the Arpeggio type assigned to the selected Voice. While referring to page 55, play the note or notes with various styles—only a single note, various notes simultaneously, same notes in various order, etc. You can hear the various Arpeggio phrases or rhythm patterns. Depending on the Arpeggio type, you may also trigger the special Accent Phrase by pressing the note strongly (with high velocities).

NOTE Some Arpeggio types include the Control Change messages. When you play back such an Arpeggio type, the sound of the current Voice may inadvertently be changed and the [E] indicator may appear in the top right of the display.

5. Press the [EDIT] button, select “Arpeggio,” then press the [ENTER] button.

The Arp Select display appears.

6. At the “Arp Select” column, select any of “ARP1” – “ARP5” (five Arpeggio types) assigned to the current Voice.

You can select and play one of the five Arpeggio types assigned to each Voice. When you want to change the settings common to all five Arpeggio types, move the cursor position to “Arp Edit” then press the [ENTER] button to call up the Arpeggio Edit display (page 66). When you want to change the Arpeggio type that is assigned to “ARP1” for example, move the cursor position to “Arp 1 Type,” then press the [ENTER] button to call up the Arp 1 – 5 Type display.

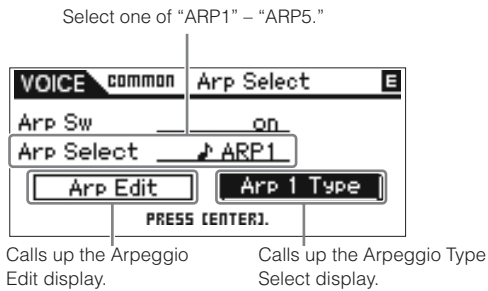

NOTE The 8th note icon at left of “ARP1” – “ARP5” indicates that the Arpeggio type has actually been assigned. No 8th note icon indicates that no Arpeggio type (“off”) is assigned and no sound is produced even when you play any note.

TIP Switching Arpeggio types using Control Change messages

The Arpeggios 1 – 5 can be also switched from an external device using Control Change messages.

1. Press the [UTILITY] button, select “Controller,” press the [ENTER] button, move the cursor position to “Arp 1-5 Ctrl No” (Arpeggio 1 – 5 Control Change number), then set the Control Change number you want to use for switching among Arp 1 – 5.

2. Move the cursor position to “Arp Assign Mode” then select one of the following values.

inc: Each time the MOTIF-RACK XS receives a Control Change message set in Step 1, Arpeggios 1 – 5 can be switched in numerical order. The actual Control Change value does not matter.

direct: You can select the Arpeggio number (ARP1 – ARP5) corresponding to the value of the Control Change message that is set in Step 1. For details, see page 102.

3. Try transmitting the Control Change message to the MOTIF-RACK XS from the external MIDI device to change the Arpeggio number (ARP1 – ARP5).

7. Press the [SELECT] button so that the lowest lamp lights, then turn Knob 5 while playing back the Arpeggio to adjust the tempo.

8. After the desired settings are completed, press the [STORE] button to store the Arpeggio related settings as User Voice data.

For information about storing the edited Voice, see page 46.

Arpeggio playback/recording in the Multi mode

In the Multi mode, an Arpeggio type can be assigned to each Part and up to four Parts can play back the assigned Arpeggio types simultaneously. This section explains how to trigger the Arpeggio types by using the note events in the track of the DAW software and how to record the MIDI notes generated via Arpeggio playback to a track in the DAW software.

NOTE For instructions on connecting the MOTIF-RACK XS to a computer, see page 17.

1. On the DAW software, record the note data (for triggering the Arpeggio) to a certain track, then set the MIDI output port of the track to USB port 1 or mLAN port 1.

NOTE For information about making these settings, refer to the manual of the DAW software.

2. On the MOTIF-RACK XS, enter the Multi mode, then select the desired Multi.

3. On the MOTIF-RACK XS, set the “Arp Common Sw” parameter to “on” in the Arpeggio display of the Common Edit.

When the “Audition Button” parameter (page 99) is set to “arpeggio sw” in the Utility General window, you can turn the arpeggio switch parameter on/off by pressing the [AUDITION] button on the panel. When the arpeggio switch parameter is set to on, the lamp of the [AUDITION] button lights.

4. In the Arp Edit display (page 96) of the Part Edit, set the “Arp Sw” parameter of the desired Part to “on,” then select the desired Arpeggio type in the Arp 1 – 5 Type display.

Set the other parameters as desired in the Arpeggio settings display. The “Arp Sw” parameter can be set to on for up to four Parts.

5. In the Voice display (page 94) of the Part Edit, set the “Receive Ch” parameter of the Part (of which the “Arp Sw” parameter is set to “on”) to that same as the Transmit Channel of the track on the DAW software.

6. Make desired MIDI clock settings for playing the Arpeggio.

Determine which clock will be used, the internal clock (of the MOTIF-RACK XS) or the external clock (from the separate MIDI device or DAW software/computer), as well as other settings. For details about these settings, refer to “Arpeggio tempo” on page 43.

7. On the DAW software, play the note data to trigger the Arpeggio of the MOTIF-RACK XS to sound the Arpeggio set on the MOTIF-RACK XS.

- 8. On the MOTIF-RACK XS, press the [STORE] button to store the current Multi after the desired settings are completed.**

For information on storing, see page 46.

Next, try recording Arpeggio playback data to a track of the DAW software.

- 9. In the Arp Edit display of the Part Edit, set the “Arp MIDI Out Sw” parameter of the Part (of which the “Arp Sw” parameter is set to “on”) to “on,” then set the “Arp Transmit Ch” to the desired channel in the same display.**

After this operation, Arpeggio playback data (MIDI data) will be transmitted to the external device (computer) over the specified MIDI channel.

- 10. On the DAW software, select an empty track, then set the MIDI output port to off.**
- 11. On the DAW software, play the note data prepared in step 1 to trigger the Arpeggio playback of the MOTIF-RACK XS, then press the record button to record the Arpeggio MIDI data to the track selected in step 9.**
- 12. After recording is completed, set the MIDI Transmit Channel of the recorded track to that same as the Parts (of which the “Arp Sw” parameter is set to on) of the MOTIF-RACK XS.**
- 13. Set the “Arp Sw” parameters of all Parts to “off” on the MOTIF-RACK XS, then play the recorded note data on the DAW software.**

The recorded note data on the DAW software will be transmitted to the MOTIF-RACK XS and play the sound of the MOTIF-RACK XS without the Arpeggio function.

Arpeggio playback with the Voices for Parts 1 – 4 simultaneously sounded.

Try playing the Multi of the Factory settings with “Layer 1 – 4 Parts” (page 98) set to “on” in the Utility General window. When “Layer 1 – 4 Parts” is set to on, the MIDI Receive Channel for the Parts 1 – 4 of the current Multi will be set to the same value as specified in the “Receive Ch (Basic Receive Channel)” parameter (page 102) in the Utility Voice MIDI window. In this setting, you can hear the multiple Arpeggio playbacks (up to four types) simultaneously by receiving the note data from the external MIDI sequencer or computer (DAW software).

NOTE Note that the MIDI Transmit Channel of the keyboard or DAW software should be set to the same value as the “Receive Ch” in the Utility Voice MIDI window of the MOTIF-RACK XS.

NOTE For details about how to use with “Layer 1 – 4 Parts” set to on, see page 40.

Arpeggio tempo

In order to synchronize the Arpeggio tempo to other devices, you can determine which clock will be used, the internal clock (of the MOTIF-RACK XS) or the external clock (from the separate MIDI device or DAW software/computer), by setting the MIDI Sync parameter (page 99) in the Utility MIDI window.

When you set this parameter so that the internal clock is used, you can determine the Arpeggio tempo by setting the “Arp Tempo” parameter (page 66) in the Arp Edit display of the Voice mode or the “Arp Tempo” parameter (page 91) in the Arp Edit display of the Multi mode.

When you set this parameter so that the external clock is used, you need to set related parameters so that the external MIDI device or computer can transmit the MIDI clocks. The instructions below explain how to set these in Cubase.

- 1. Select “Sync Setup” from the “Transport” menu in Cubase to call up the Synchronization Setup dialog.**

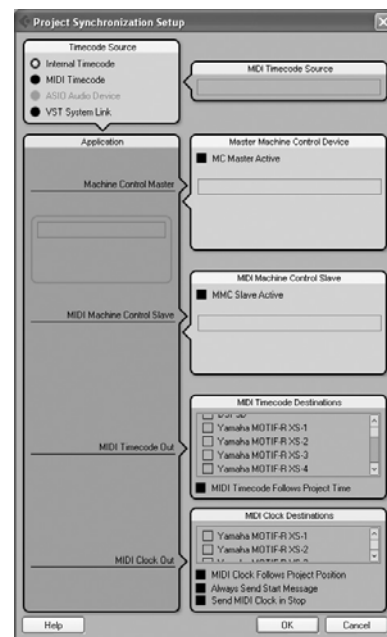

- 2. Enter checkmarks to the USB or mLAN Port1 of the MOTIF-RACK XS and “MIDI Clock Follows Project Position” of the “MIDI Clock Destination” at the lower right of the dialog.**

When connecting via a USB cable, enter the checkmark to “Yamaha MOTIF-R XS-1” or “MOTIF-R XS Port1.” When connecting via an IEEE1394 cable, enter the checkmark to “mLAN MIDI Out” or “MOTIF-RACK XS.”

- 3. Click [OK] to close the “Synchronization Setup” dialog.**

NOTE MIDI clock is transmitted from Cubase (on the computer) only when recording or playback is performed on Cubase.

NOTE For information about DAW software other than Cubase and how to transmit clock data from the MIDI device, refer to the owner’s manual of your particular DAW software/MIDI device.

Controlling from an External MIDI Keyboard

To use the MOTIF-RACK XS, you'll need an external keyboard (with various controllers, such as a pitch bend wheel, modulation wheel, etc.). The MOTIF-RACK XS's tone generator block produces the sound according to the MIDI messages received from the keyboard and computer.

External controllers supported by the MOTIF-RACK XS

The MOTIF-RACK XS can be played by connecting an external MIDI keyboard or synthesizer, and can be controlled by the MIDI controllers on the keyboard—pitch bend wheel, modulation wheel, ribbon controller, knobs, sliders, etc. In addition, you can also control the MOTIF-RACK XS using an optional Yamaha BC3 Breath Controller, FC4/FC5 Footswitch, FC7/FC9 Foot Controller, etc. by connecting these controllers to the external device.

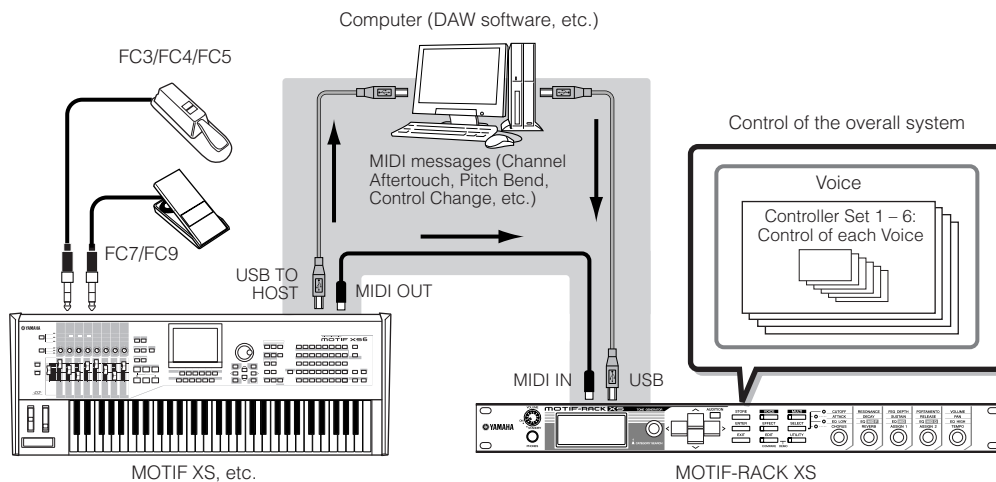

Controlling a Voice with Controller Set

[VOICE] → select a Voice → [EDIT] → select “Controller” → [ENTER] → Control display (page 71)

You can freely assign a variety of different functions to the external controllers. For example, you could have the Modulation Wheel control filter resonance and set aftertouch to apply vibrato. The settings for all external controllers are referred to as a “Controller Set,” and up to six Controller Sets can be created for each Voice.

NOTE You can assign a variety of functions to Knob 3 (ASSIGN 1) and Knob 4 (ASSIGN 2) as well as the external controllers.

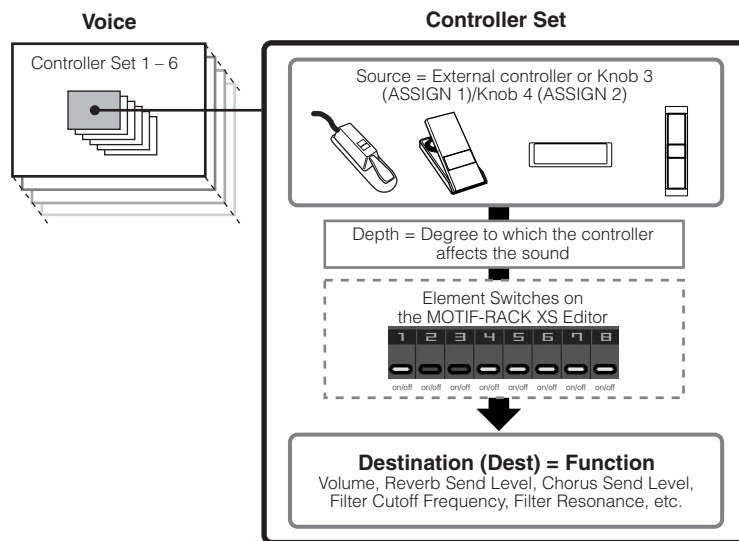

NOTE You can set whether the controller affects each Element by setting the Element Switch of the Controller Set on or off as desired. Note that this applies only to Normal Voices. The Element Switch parameter can be set only on the MOTIF-RACK XS Editor.

NOTE The Element Switch parameters of the Controller Set are not available when a function unrelated to the Elements is set as the destination.

Source and Destination

The term "source" refers to the hardware controller and "destination" refers to the parameter or function being controlled. An extensive variety of destination parameters are available, far more than those listed in the previous page. For a complete list of destination parameters, see the separate Data List.

For example, in the instructions below, we'll control panning with an external assignable controller after connecting the external controller to the MOTIF-RACK XS.

1. Set the "Ctrl Set 1 Src" parameter to "Assign 1" in the VOICE COMMON Control display, then confirm the Control Number for "Assign 1."

The Control Number is displayed in parentheses following "Assign 1."

Control Number

VOICE common Control 2/4		E
Ctrl Set 1 Src	Assign 1 (15)	
Dest	chorus send	
Depth	+17	
Ctrl Set 2 Src	Assign 1 (16)	
Dest	insA EQ5 Gain	
Depth	+13	

NOTE For the source parameters, refer to "Ctrl Set 1 – 6 Src (Controller Set 1 – 6 Source)" on page 71.

NOTE You can change the Control Number corresponding to the source controller (see right).

2. On the external controller device connected to the MOTIF-RACK XS, make sure that the "Assign 1" setting matches the Control Number generated by operating the relevant controller.

For details on how to do this, refer to the owner's manual of your particular device.

3. Set the "Ctrl Set 1 Dest" parameter to "E-Pan" (Element Pan).

NOTE For details on the available Destination parameter settings, refer to the Control List in the separate Data List booklet.

4. Set the depth of control by changing the "Ctrl Set 1 Depth" parameter setting.

5. Repeat Steps 1 and 3 above to assign the remaining Control Sets 2 through 6.

6. Play the sound of the MOTIF-RACK XS and try out the corresponding controller.

NOTE You can control the functions specified as destination of "Assign 1" and "Assign 2" by operating Knobs 3 and 4 respectively as well as the external controllers.

NOTE When at least one of the "LFO Set 1 – 3 Element Sw" parameters is set to "off" and the Element related parameters are assigned to any of the "Ctrl Set 1 – 6 Dest" parameters, an exclamation mark (!) is shown at the beginning of the value for "Ctrl Set 1 – 6 Src," "Ctrl Set 1 – 6 Dest" and "Ctrl Set 1 – 6 Depth." This indicates that the function specified as destination is not applied to all the Elements.

Using one source to control several destinations

For example, set the Src (Source) parameter of Control Set 1 to "ModWheel" (Modulation Wheel) and the Dest (Destination) parameter to "E-LFO PMD" (Element LFO Pitch Modulation Depth). Then set the Src (Source) parameter of Control Set 2 also to MW, but set the Dest parameter to "E-Pan" (Element Pan). In this example, when you move the Modulation Wheel upward, the amount of Pitch Modulation increases accordingly, and the Element is panned from left to right. In this way, you can have the sound change in several different ways, simply by adjusting a single controller.

Using several sources to control one destination

For example, set the Src (Source) parameter of Control Set 1 to "ModWheel" (Modulation Wheel) and the Dest (Destination) parameter to "E-LFO PMD" (Element LFO Pitch Modulation Depth). Then set the Src (Source) parameter of Control Set 2 to "Ribbon" (Ribbon Controller) and set the Dest parameter also to "E-LFO PMD." Now, Pitch Modulation is assigned to both the Modulation Wheel and Ribbon Controller. This can be useful in live performance situations, letting you use any one of several controllers depending on which is convenient at the time. In this way, you can have several different controllers affect the same aspect of the sound.

NOTE The Controller Set edited in the Voice Edit mode is available when the corresponding Voice is selected in the Multi mode.

NOTE Make sure to match the MIDI channel between the MOTIF-RACK XS and external controller.

In the Voice mode, set the transmit channel of the external controller to the same one as the Basic Receive channel (set in the Utility mode) of the MOTIF-RACK XS, and vice versa. In the Multi mode, likewise, set the transmit channel of the external controller to the same one as the Receive channel for the Part you want to control of the MOTIF-RACK XS, and vice versa.

Assigning Control numbers

Each external controller has a pre-assigned Control Change number. When operating the external controller, each Control Change message assigned to each controller is transmitted to the MOTIF-RACK XS, and the Destination (function) corresponding to the Control Number is performed. The Control Number assignments on the MOTIF-RACK XS can be made from the Utility Controller window (page 101).

NOTE The Control Numbers for Aftertouch, Pitch Bend, and Modulation Wheel are not changed.

NOTE Depending on the Control Change number settings of the "Ctrl Set 1 – 6 Src" parameter, the conventional functions of the Control Change messages may be disabled.

Storing the Edited Voice, Multi and Utility Settings

The edited Voice, Multi and Utility settings can be stored in the internal Flash ROM (page 48). In addition, the Voice or Multi data currently being edited can be transferred to the external MIDI device or computer (DAW software) as bulk data (consisting of MIDI system exclusive messages) and saved as a file.

Storing the edited Voice, Multi and Utility settings in the internal Flash ROM

The edited Voice, Multi and Utility settings can be stored by following the instructions below. If you want to change the name of the Voice or Multi, execute the Rename operation (page 47) before executing the Store operation.

CAUTION

When you store the Voice or Multi, the destination data will be overwritten. Important data should always be backed up as an MOTIF-RACK XS Editor file.

1. After editing is finished, press the [STORE] button. The Store window appears.

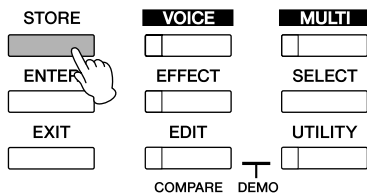

Example when a Normal Voice is selected

Voice Bank and Number as starting data of the Voice currently being edited



NOTE Pressing the [STORE] button in the Utility mode will store the Utility settings immediately without any confirmation message.

2. Move the cursor position to the Bank column with the Cursor [\leftarrow] button, then select the destination Bank with the Encoder knob, and move the cursor position to the Number column with the Cursor [\rightarrow] button. This step is necessary only when a Normal Voice is edited in the Voice mode.
3. Select a destination Voice number or Multi number by using the Encoder knob.

4. Press the [ENTER] button or the Encoder knob to execute the Store operation. The display prompts you for confirmation.



Press the [ENTER] button or the Encoder knob to execute the Store operation. A "Completed" message appears when the data has been stored, and the destination Voice or Multi is shown in the display.

NOTE To cancel the Store operation, press the [EXIT] button instead of the [ENTER] button. The Store operation will not be executed and the display returns to the original one.

CAUTION

Never attempt to turn off the power while data is being stored (while an "Executing..." or "Please keep power on" message is shown). Turning the power off in this state results in loss of all user data.

Store Compare function

When the Voice Store or Multi Store window is shown, the [EDIT] button's lamp flashes and the "STORE COMPARE" appears in the display. In this status (referred to as "Store Compare mode"), you can hear the sound of the destination Voice or Multi by playing the Audition Phrase (page 16) or playing the connected external MIDI keyboard.

Pressing the [EDIT] button again exits from this status.

Indicates that Store Compare is active.



Saving data to an external device (Bulk Dump)

You can archive or back up the current status (data in the Edit buffer) of the Voice Edit or Multi Edit by using the Bulk Dump function to transmit the data to the DAW software on your computer connected to the MOTIF-RACK XS.

NOTE For details about how to connect the MOTIF-RACK XS to a computer, see page 17.

NOTE In order to properly use Bulk Dump, the MIDI Device Number and the Receive Bulk Switch parameter must be set properly. For details, see page 100.

Transmitting and saving data

1. On the DAW software, create a new Project, then start recording.
2. On the MOTIF-RACK XS, hold the [VOICE] button or [MULTI] button then press the [STORE] button.
The current status (on the Edit buffer) of the Voice Edit or Multi Edit will be transmitted and recorded to the DAW software on your computer.
NOTE When bulk data transmission does not work properly, try increasing the transmit interval value ("Bulk Interval" parameter). See page 100.
3. On the DAW software, save the Project file to which the bulk data has been recorded.

Recalling data from the DAW software

1. On the DAW software, open the Project file including the data you want to call up.
2. On the MOTIF-RACK XS, enter the Voice mode or Multi mode according to the data type you want to call up from the DAW software.
If the bulk data is for Normal Voices, select a Normal Voice in the Voice mode. Likewise, if the bulk data is for Drum Voices, select a Drum Voice; if it is for Multis, select the Multi mode.
3. On the DAW software, play back the Project file including the bulk data.
The bulk data will be transmitted from the DAW software (computer) to the MOTIF-RACK XS and then restored on the Edit buffer as the current Voice or Multi.

CAUTION

When the MOTIF-RACK XS receives bulk data, the settings are overwritten and replaced with the settings from the bulk data. Be careful not to overwrite any important data.

Voice/Multi Name settings (Entering Characters)

In the Name display of the Voice or Multi Common Edit mode, you can assign the desired name to the current Voice or Multi. In this section, you'll see how to enter characters in the Name display.

1. Call up the Name display then move the cursor position to "Name" (pages 65 or 91).

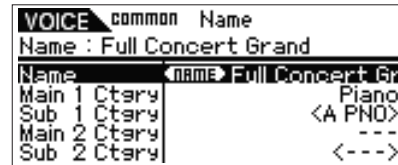

2. Press the [ENTER] button or Encoder knob to call up the Name dialog.

In the Character list, the cursor is located at the left top of this area. In the Name Edit area, the cursor is located at the left end.

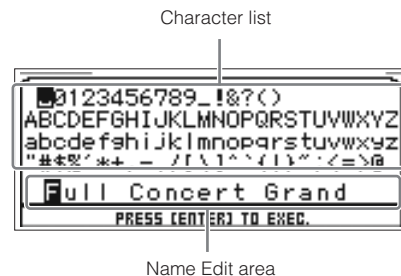

3. Press the Cursor [<] and [>] buttons to move the cursor to the desired location in the Name Edit area.
4. Turn the Encoder knob to select the desired character in the Character List.
5. Press the Cursor [<] and [>] buttons to move to the next desired location in the Name Edit area.
6. Repeat steps 4 – 5 as necessary.
7. After entering the name, press the [ENTER] button.

The Controls & Connectors

Setting Up

Listening to the Sound

Connections

Using a Computer

Quick Guide

Basic Structure

Voice

Multi

Utility

Appendix

Reference

Internal Memory

Below are explanations of the internal memory used in the MOTIF-RACK XS.

Flash ROM

ROM (Read Only Memory) is memory designed specifically for reading out of data, and as such data cannot be written to it. Unlike conventional ROM, Flash ROM can be overwritten—allowing you to store your own original data. The contents of Flash ROM are maintained even when the power is turned off.

DRAM

RAM (Random Access Memory) is memory designed specifically for data writing and data reading operations. There are two different kinds of RAM, depending on the condition for storing the data: SRAM (Static RAM) and DRAM (Dynamic RAM). The MOTIF-RACK XS is equipped with only DRAM. The created data stored on DRAM is lost when the power is turned off. Because of this, you should always store any data residing in DRAM to the Flash ROM or the computer connected to the MOTIF-RACK XS before turning off the power.

Edit Buffer and User Memory

The edit buffer is the memory location for edited Voice and Multi data. Data edited in this location will be stored to the User Memory. If you select another Voice or Multi, the entire contents of the edit buffer will be rewritten with the newly selected Voice/Multi data. Make sure to store any important data before selecting another Voice, etc.

Resetting the User Memory to the Initial Factory Settings

The original factory settings of this instrument's User Memory can be restored as follows.

NOTE When connecting a computer to the MOTIF-RACK XS via a IEEE1394 cable, disable the driver used for this connection beforehand, and follow the procedure below to execute Factory Set.

CAUTION

When the factory settings are restored, all the Voice, Multi, and system settings in the Utility mode you created will be erased. Make sure you are not overwriting any important data. Be sure to save all important data to a computer before executing this procedure (page 47).

1. Press the [UTILITY] button.

The Utility Select window appears.



This window can be called up from the Voice mode.

2. Select "Fctry Set" by using the Cursor [▲]/[▼]/[<]/[>] buttons or Encoder knob, then press the [ENTER] button or Encoder knob.

The Factory Set window appears.



CAUTION

When setting the Auto Factory Set parameter to on and pressing the [ENTER] button, the Factory Set will automatically be executed each time the power is turned on. Keep in mind that this also means that your original data in Flash ROM will be erased each time you turn on the power. Therefore, the Auto Factory Set parameter should normally be set to off. When setting the Auto Factory Set parameter to off and pressing the [ENTER] button, the Factory Set will not be executed when turning the power on next time.

3. Press the [ENTER] button or Encoder knob to execute Factory Set.

The display prompts you for confirmation. Press the [ENTER] button or Encoder knob again to execute Factory Set. After Factory Set has been completed, operation returns to the Voice Play display. Press the [EXIT] button to cancel the Factory Set operation.

CAUTION

For Factory Set operations that take longer to process, you will see the message "Now executing Factory Set..." during processing. While such a message is shown on the display, never attempt to turn off the power while data is being written to Flash ROM. Turning the power off in this state results in loss of all user data and may cause the system to freeze (due to corruption of data in the Flash ROM). This means that this tone generator may not be able to start up properly, even when turning the power on next time.

Basic Structure

The Five Functional Blocks

The MOTIF-RACK XS system consists of five main functional blocks: Tone Generator, Audio Input, Arpeggio, Controller, and Effect.

MOTIF-RACK XS

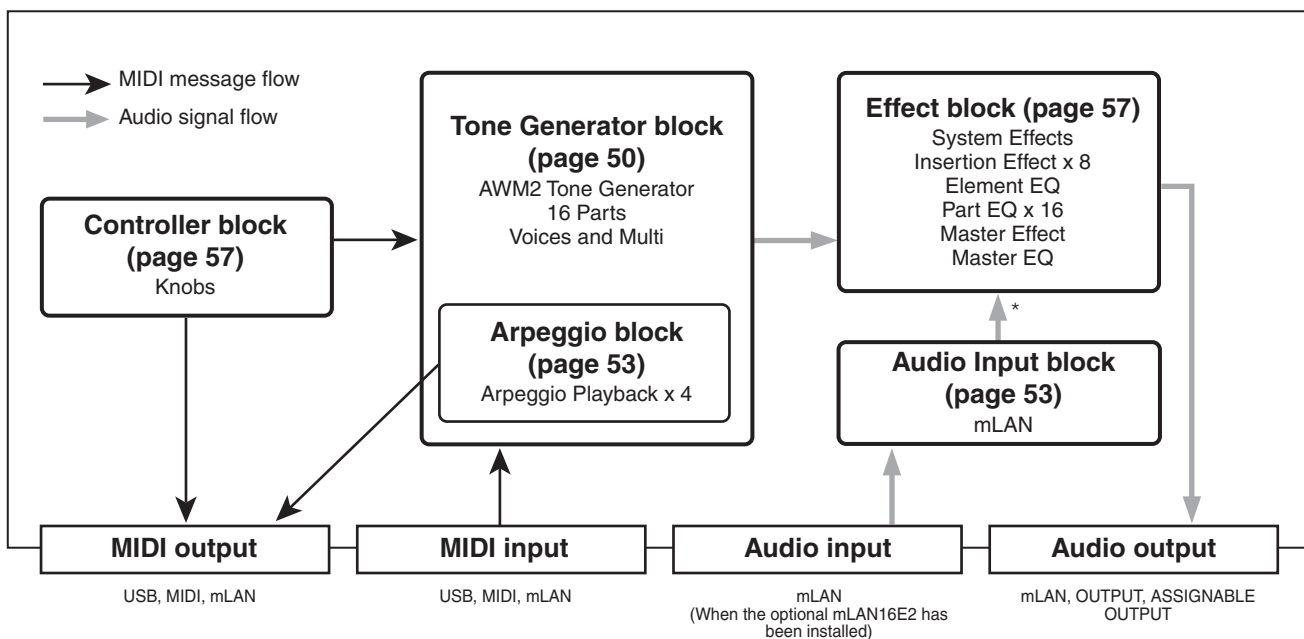

*Audio Signals from the Audio Input block can be transmitted to the only System Effects, Master Effect, and Master EQ of the Effect Block.

AWM2 (Advanced Wave Memory 2)

This instrument is equipped with AWM2 tone generator block. AWM2 (Advanced Wave Memory 2) is a synthesis system based on sampled waves (sound material), and is used in many Yamaha synthesizers. For extra realism, each AWM2 Voice uses multiple samples of a real instrument's waveform. Furthermore, a wide variety of parameters—envelope generator, filter, modulation, and others—can be applied.

Tone Generator Block

The tone generator block is what actually produces sound in response to the MIDI messages received from the Sequencer block, the Controller block, the Arpeggio block and from the external MIDI instrument via the MIDI IN terminal, the USB terminal, or the mLAN terminal. The MIDI messages are assigned to sixteen independent channels, and this instrument is capable of handling sixteen MIDI channels. The sixteen-channel limit can be overcome by using separate MIDI "ports," each supporting sixteen channels. The tone generator block responds to those MIDI messages assigned to Port 1. The structure of the tone generator block differs depending on the mode.

Tone Generator block in the Voice mode

Part structure in the Voice mode

In this mode, the tone generator block receives MIDI data over a single channel. This status is referred to as a "single timbre" tone generator.

The MIDI receive channel in the Voice mode can be determined by setting the Receive Ch (Basic Receive Channel) parameter (page 102) in the Voice MIDI window of the Utility mode.

NOTE Keep in mind that song data on an external sequencer consisting of multiple MIDI channels will not play back properly in this mode. If you are using an external MIDI sequencer or computer to play the instrument, make sure to use the Multi mode.

Voice

A program that contains the sonic elements for generating a specific musical instrument sound is referred to as a "Voice." Internally, there are two Voice Types: Normal Voices and Drum Voices. Normal Voices are mainly pitched musical instrument type sounds that can be played over the range of a keyboard. Drum Voices are mainly percussion/drum sounds that are assigned to individual notes on the keyboard.

Each Voice consists of up to eight elements (Normal Voice) or up to 73 keys (Drum Voice). The elements and keys are the smallest unit that make up a Voice, and to each can be assigned a different instrument sound. Voice data consists of the Element Edit parameters (for each element)/Key Edit parameters (for each key) and Common Edit parameters (applied commonly to all the elements/keys). The Common Edit parameters can be edited on the MOTIF-RACK XS while the Element Edit/Key Edit parameters can be edited only on the MOTIF-RACK XS Editor installed to your computer.

NOTE For instructions on editing a Normal Voice, see page 64. For instructions on editing a Drum Voice, see page 83.

Normal Voices and Drum Voices

Normal Voices

These are Voices which are played conventionally from the keyboard, with standard pitches sounding for each key. A Normal Voice consists of up to eight Elements. Depending on the settings in the Voice Edit mode, these Elements are sounded simultaneously, or the different Elements are sounded according to the note range, velocity range and the XA (Expanded Articulation) settings.

The illustration below is an example of a Normal Voice. Since the six Elements here are distributed across both the note range of

the keyboard and the velocity range, a different Element sounds depending on which note you play and how strongly you play it. In the note distribution, Elements 1 and 2 sound in the lower range of the keyboard, Elements 3 and 4 sound in the middle range, and Elements 5 and 6 sound in the higher range. In the velocity distribution, Elements 1, 3 and 5 sound when playing the keyboard softly, while Elements 2, 4 and 6 sound when playing it strongly. In a practical example of this in use, a piano Voice could be composed of six different samples. Elements 1, 3 and 5 would be the sounds of the piano played softly, over the respective note ranges, while Elements 2, 4 and 6 would be strongly played sounds, for each respective note range. Actually, the MOTIF-RACK XS is even more flexible than this, since it allows up to eight independent Elements.

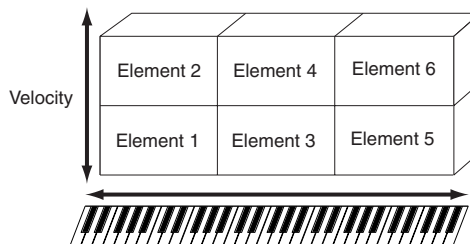

Drum Voices

Drum Voices are mainly percussion/drum sounds that are assigned to individual notes on the keyboard. A collection of assigned percussion/drum waves or Normal Voices is known as a Drum Kit.

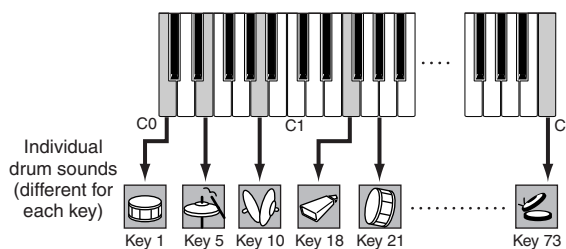

Expanded Articulation (XA)

Expanded Articulation (XA) is a specially designed tone generation system used by the MOTIF-RACK XS that provides greater performance flexibility and acoustic realism. It allows you to more effectively recreate realistic sound and natural performance techniques—such as legato and staccato—and provides other unique modes for random and alternate sound changes as you play.

Realistic legato performance

Conventional synthesizers recreate a legato effect by continuing the volume envelope of a previous Note On to the next one, in the mono mode. However, this results in an unnatural sound different from that of an actual acoustic instrument. The MOTIF-RACK XS more accurately reproduces a legato effect by allowing specific Elements to be sounded when playing legato and other Elements to be played normally (with the XA Control parameter settings “normal” and “legato”).

Authentic note release sound

Conventional synthesizers do not adequately reproduce the special sounds or nuances that occur when a note on an actual acoustic instrument is released. The MOTIF-RACK XS is capable of realizing these subtle sonic nuances by setting the XA Control parameter of a certain Element to “key-off sound.”

Subtle sound variations for each note played

Conventional synthesizers attempt to reproduce this by randomly changing the pitch and/or filter. However, this produces an electronic effect and is different from the real sound changes on an acoustic instrument. The MOTIF-RACK XS more accurately reproduces these subtle sound variations by using the XA Control parameter settings, “wave cycle” and “wave random.”

Switching among different sounds to recreate the natural performance on an acoustic instrument

Acoustic instruments have their own unique characteristics—even specific, unique sounds that are produced only at certain times in a performance. These include the flutter tonguing on a flute or playing high harmonics on an acoustic guitar. The MOTIF-RACK XS recreates these by allowing you to switch between the sounds while you play—setting the A.Func [1] button and A.Func [2] button on the synchronized MOTIF-RACK XS Editor to on/off, with the XA Control parameter settings, “AF 1 on,” “AF 2 on” and “all AF off.”

NOTE The A.Func [1] button and A.Func [2] button can also be set to on/off by transmitting the Control Change messages assigned to the “A.Func1 Ctrl No.” and “A.Func2 Ctrl No.” parameters in the Utility Controller window (page 102) from the external device.

New sounds and new styles of playing

The highly versatile functions above can be applied effectively not only to acoustic sounds but also to synthesizer and electronic Voices as well. The XA feature opens up enormous potential for realizing authentic sounds, performing expressively and coming up with creative new styles of playing.

To create sounds such as those described above using Expanded Articulation, refer to page 73.

Elements and Drum Keys

Elements and Drum Keys are the smallest “building blocks” in the MOTIF-RACK XS that comprise a Voice; in fact, only one Element or one Drum Key could be used to create a Voice. These small sound units can be built, enhanced and processed by a variety of traditional synthesizer parameters, such as Oscillator, Pitch Filter, Amplitude, and LFO (shown below).

IMPORTANT

Keep in mind that these Element and Drum Key parameters can be conveniently and easily edited on the MOTIF-RACK XS Editor (installed to your computer) instead of the MOTIF-RACK XS instrument.

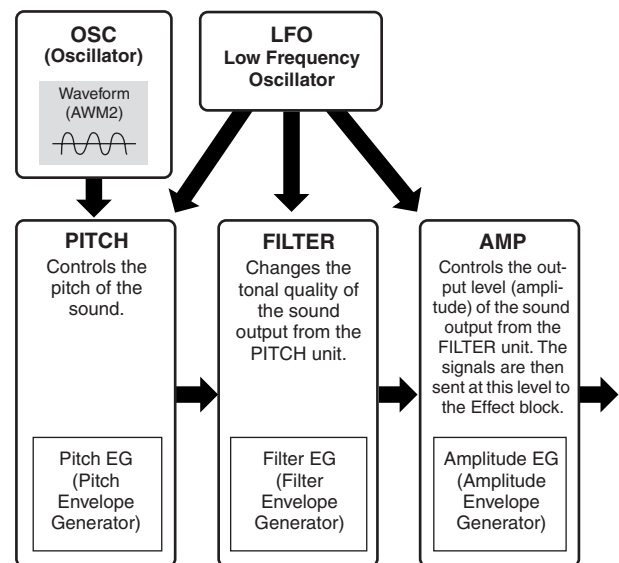

Oscillator

This unit outputs the wave which determines the basic pitch. You can assign the waveform (or basic sound material) to each Element of a Normal Voice or each Key of a Drum Voice. In the case of a Normal Voice, you can set the note range for the Element (the range of notes on the keyboard over which the Element will sound) as well as the velocity response (the range of note velocities within which the Element will sound). In addition, the XA related parameters can be set in this unit. Oscillator related parameters (pages 73 and 84) can be set on the MOTIF-RACK XS Editor.

Pitch

This unit controls the pitch of the sound (wave) output from the Oscillator. In the case of a Normal Voice, you can detune separate Elements, apply Pitch Scaling and so on. Also, by setting the PEG (Pitch Envelope Generator), you can control how the pitch changes over time. Pitch-related parameters (pages 74 and 85) can be set on the MOTIF-RACK XS Editor.

Filter

This unit modifies the tone of the sound output from Pitch by cutting the output of a specific frequency portion of the sound. Also, by setting the FEG (Filter Envelope Generator), you can control how the Cutoff Frequency of the Filter changes over time. Filter related parameters (pages 76, 77, 78, and 85) can be set on the MOTIF-RACK XS Editor.

Amplitude

This unit controls the output level (amplitude) of the sound output from the Filter block. The signals are then sent at this level to the Effect block. Also, by setting the AEG (Amplitude Envelope Generator), you can control how the volume changes over time. Amplitude related parameters (pages 78, 81, 85 and 86) can be set on the MOTIF-RACK XS Editor.

LFO (Low Frequency Oscillator)

As its name suggests, the LFO produces a wave of a low frequency. These waves can be used to vary the pitch, filter or amplitude of each Element to create effects such as vibrato, wah and tremolo. LFO can be set independently for each Element; it can also be set globally for all Elements.

Among the LFO related parameters, the Common Edit parameters can be set in the Common LFO display (page 69) and the Element Edit parameters (page 81) can be set on the MOTIF-RACK XS Editor.

Memory structure of Voice

Normal Voice

- Preset Banks 1 – 8: 1024 Normal Voices (128 Voices for each Bank)
- GM Bank: 128 Voices
- User Banks 1 – 3: 384 Normal Voices (128 Voices for each Bank)
(selected from Preset Voices by default)

Drum Voice

- Preset Drum Bank: 64 Voices
- GM Drum Bank: 1 Voice
- User Drum Bank: 32 Voices
(selected from Preset Voices by default)

Tone Generator block in the Multi mode

Part structure in the Multi mode

In this mode, multiple Parts are provided and different Voices and different melodies or phrases can be played back for each Part. This status is referred to as a “multi timbral” tone generator. Because this mode lets you set the MIDI channel for each part of the tone generator block, you can use an external MIDI sequencer to play the sounds. The sequence data of each track on the external MIDI sequencer plays the corresponding Parts (those having the same MIDI channel assignment) in the tone generator block.

To play the tone generator in the Multi mode, set the MIDI Port to 1 on the external MIDI sequencer or computer then set a MIDI Receive channel (page 94) for each of 16 Parts in the Voice display of the Multi Part Edit, according to the MIDI transmit channel for each track of the external MIDI sequencer or computer.

Multi

A program in which multiple Voices are assigned to Parts for multi-timbral play is referred to as a “Multi” on the MOTIF-RACK XS or “Mixing” on certain Yamaha synthesizers. Each Multi program can contain up to 16 parts and can be created by editing parameters unique to each Part and parameters common to all the Parts in the Multi mode.

Memory structure of Multi

128 Multi programs are programmed in the User Bank.

Maximum Polyphony

Maximum polyphony refers to the highest number of notes that can be sounded simultaneously from the internal tone generator of the instrument. The maximum polyphony of this tone generator is 128. When the internal tone generator block receives a number of notes exceeding the maximum polyphony, previously played notes are cut off. Keep in mind this may be especially noticeable with Voices not having decay. Furthermore, the maximum polyphony applies to the number of Voice Elements used, not the number of Voices. When Normal Voices that include up to eight Elements are used, the maximum number of simultaneous notes may be less than 128.

Audio Input Block

This block handles the audio signal input from the mLAN terminal (available only when the optional mLAN16E2 has been installed). Various parameters such as volume, pan, and effect can be set for the audio signal and the sound is output together with other Voices. The System Effects, Master Effects and Master EQ can be applied to the audio signal input via the mLAN terminal. The Audio Input related parameters can be set in the following display.

Mode	Display	Page
Voice mode	Voice mLAN window of the Utility mode	page 102
Multi mode	mLAN In display of the Multi Common Edit	page 91

Arpeggio Block

This block lets you automatically trigger musical and rhythmic phrases using the current Voice by simply pressing a note or notes on the external MIDI keyboard. The Arpeggio sequence also changes in response to the actual notes or chords you play, giving you a wide variety of inspiring musical phrases and ideas—both in composing and performing.

Arpeggio Category

The Arpeggio types are divided into 17 categories as listed below.

Category List

ApKb	Acoustic Piano & Keyboard
Organ	Organ
GtPl	Guitar / Plucked
GtMG	Guitar for "Mega Voice"
Bass	Bass
BaMG	Bass for "Mega Voice"
Strng	Strings
Brass	Brass
RdPp	Reed / Pipe
Lead	Synth Lead
PdMe	Synth Pad / Musical Effect
CPrc	Chromatic Percussion
DrPc	Drum / Percussion
Seq	Synth Seq
Chord	Chord Seq
Hybrd	Hybrid Seq
Cntr	Control

NOTE Categories named "GtMG" and "BaMG" include Arpeggio types appropriate for using with a Mega Voice.

Mega Voices and Mega Voice Arpeggios

Normal Voices use velocity switching to make the sound quality and/or level of a Voice change according to how strongly or softly you play the keyboard. This makes these Voices respond naturally. However Mega Voices have a very complex structure with many different layers, and are not suitable for playing manually. Mega Voices were developed specifically to be played by Mega Voice arpeggios to produce incredibly realistic results. You should always use Mega Voices with Mega Voice Arpeggios (included in "GtMG" and "BaMG" category). For information about appropriate Arpeggio type for each Mega Voice, refer to the Voice Type column of the Arpeggio Type List, separate online documentation.

Arpeggio Sub Category

The Arpeggio categories are divided into sub categories as listed below. Because the sub categories are listed based on music genres, it is easy to find the sub category appropriate for your desired music style.

Sub Category List

Rock	Rock	Z.Pad	Zone Velocity for Pad*
R&B	R&B	Filtr	Filter
Elect	Electronic	Exprs	Expression
Jazz	Jazz	Pan	Pan
World	World	Mod	Modulation
Genrl	General	Pbend	Pitch Bend
Comb	Combination	Asign	Assign 1/2
Zone	Zone Velocity*		

NOTE Arpeggio types belonging to the Sub Categories marked with an asterisk (*) contain some velocity ranges, to each of which a different phrase is assigned. When a type of these categories is selected, it is a good idea to set the Velocity Limit of each Element to the same range as below.

Velocity ranges of each Arpeggio type

2Z_****: 1 – 90, 91 – 127

4Z_****: 1 – 70, 71 – 90, 91 – 110, 111 – 127

8Z_****: 1 – 16, 17 – 32, 33 – 48, 49 – 64, 65 – 80, 81 – 96, 97 – 108, 109 – 127

PadL_****: 1 – 1, 2 – 2, 3 – 127

PadH_****: 1 – 112, 113 – 120, 121 – 127

Arpeggio Type Name

The Arpeggio Types are named according to certain rules and abbreviations. Once you understand these rules and abbreviations, you'll find it easy to browse through and select the desired Arpeggio Types.

Arpeggio type with “_ES” at the end of the type name (example: HipHop1_ES)

These Arpeggios created for use of Normal Voices will be played back matching the played notes (page 55).

Arpeggio type with “_XS” at the end of the type name (example: Rock1_XS)

These Arpeggios created for Normal Voices use a newly developed chord recognition technology to determine what notes should be played back by the Arpeggio.

Arpeggio type with a normal name (example: UpOct1)

In addition to the above types, there are three other playback types: the Arpeggios created for use of Normal Voices and played back using only the played notes and their octave notes (page 55), the Arpeggios created for use of Drum Voices (page 55), and Arpeggios containing mainly non-note events (page 56).

How to use the Arpeggio Type List

The Arpeggio Type list (separate online documentation) contains the following columns.

1	2	3	4	5	6	7	8	9	10
Main Category	Sub Category	ARP No.	ARP Name	Time Signature	Length	Original Tempo	Accent	Random SFX	Voice Type
ApKb	Rock	1	70sRockB	4 / 4	2	130			Acoustic Piano
ApKb	Rock	2	70sRockC	4 / 4	1	130			
ApKb	Rock	3	70sRockD	4 / 4	2	130			
ApKb	Rock	4	70sRockE	4 / 4	4	130			
ApKb	Rock	5	70sRockF	4 / 4	2	130			
ApKb	Rock	6	70sRockG	4 / 4	1	130			
ApKb	Rock	7	70sRockH	4 / 4	1	130			

NOTE Note that this list is for illustration purposes only. For a complete listing of the Arpeggio Types, refer to the Arpeggio Type list (separate online documentation).

1 Main Category

Indicates an Arpeggio Category.

2 Sub Category

Indicates an Arpeggio Sub Category.

3 ARP No. (Arpeggio Number)

Indicates the Arpeggio Type Number.

4 ARP Name

Indicates the Arpeggio Name.

5 Time Signature

Indicates the time signature or meter of the Arpeggio type.

6 Length

Indicates the data length (amount of measures) of the Arpeggio type. When the Loop parameter (*) is set to “off,” the Arpeggio plays back for this length and stops.

7 Original Tempo

Indicates the appropriate tempo value of the Arpeggio type. Note that this tempo is not set automatically when selecting an Arpeggio type.

8 Accent

The circle indicates that the Arpeggio uses the Accent Phrase feature (page 55).

9 Random SFX

The circle indicates that the Arpeggio uses the SFX feature (page 55).

10 Voice Type

Indicates the voice type appropriate for the Arpeggio Type. When the Voice With Arpeggio parameter (page 96) is set to “on” in the Multi mode, the voice of this type is automatically selected.

* The “Loop” parameter can be set in the Arp Edit display (pages 66 and 96) of Voice Common Edit and Multi Part Edit.

Arpeggio related settings

There are several methods for triggering and stopping the Arpeggio playback. In addition, you can set whether or not SFX sounds and special Accent Phrases are triggered along with the normal sequence data. This section covers the Arpeggio related parameters which can be set in the Voice and Multi modes.

Turning Arpeggio playback on/off

The following three settings are available for turning the Arpeggio playback on/off.

To play the Arpeggio only when the note is pressed:	Set the “Hold” parameter to “off” and the “Trigger mode” to “gate.”
To continue the Arpeggio even if the note is released:	Set the “Hold” parameter to “on.”
To toggle the Arpeggio playback on/off whenever the note is pressed:	Set the “Trigger mode” to “toggle.” The “Hold” parameter can be set to either “on” or “off.”

The “Hold” parameter and “Trigger Mode” parameter can be set in the Arp Edit display (pages 66 and 96) of Voice Common Edit and Multi Part Edit.

NOTE When receiving the MIDI sustain message (control change #64) with the “Arp Sw” set to “on,” you can obtain the same result by setting the “Arp Hold” to “on.”

Controlling Arpeggio tempo by using a knob

When the lowest lamp is turned on by pressing the [SELECT] button a few times, you can control Arpeggio playback tempo by turning the right end knob as illustrated below. Try this out and listen for the changes in the tempo.

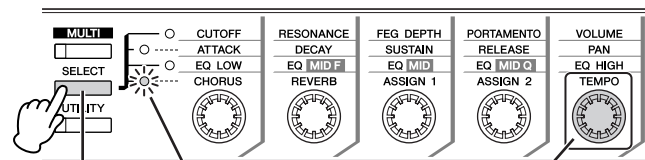

Press this button a few times so that the lowest lamp lights.

The lamp is turned on.

Turn this knob to control the tempo of Arpeggio playback

NOTE When you wish to control Arpeggio playback tempo by turning the knobs on the MOTIF-RACK XS, make sure to set "MIDI Sync" of the Utility MIDI window to "Internal."

Accent Phrase

Accent Phrases are composed of sequence data included in some Arpeggio types, sounding only when you play notes (on an external MIDI keyboard) at a velocity higher (stronger) than that specified in the Accent Velocity Threshold parameter. If it is hard to play at velocities necessary to trigger the Accent Phrase, set the Accent Velocity Threshold parameter to a lower value.

NOTE The Accent Velocity Threshold parameter can be set in the Arp Edit display (pages 66 and 96) of Voice Common Edit and Multi Part Edit.

NOTE For information on Arpeggio types that use this function, refer to the Arpeggio Type List in the Arpeggio Type List (PDF) documentation, available from the online Yamaha Manual Library.

Random SFX

Some Arpeggio types feature a Random SFX function which will trigger special sounds (such as guitar fret noises) when the note is released. The following parameters affecting Random SFX are provided.

For turning the Random SFX on/off:	Random SFX parameter
For setting the volume of the SFX sound:	Random SFX Velocity Offset parameter
For determining whether or not the volume of the SFX sound is controlled by velocity:	Random SFX Key On Control parameter

NOTE The Random SFX, SFX Vel Offset and SFX Key on Ctrl parameters can be set in the Arp Edit display (pages 66 and 96) of Voice Common Edit and Multi Part Edit.

NOTE For information on Arpeggio types that use this function, refer to the Arpeggio Type List in the Arpeggio Type List (PDF) documentation, available from the online Yamaha Manual Library.

Arpeggio playback types

The Arpeggio playback features three main playback types as described below.

Arpeggio Types for Normal Voices

Arpeggio types (belonging to the categories except for the DrPc and Cntr) created for use of Normal Voices have the following three playback types.

Playback only of the played notes

The Arpeggio is played back using only the played note and its octave notes.

Playback of a programmed sequence according to the played notes

These Arpeggio types have the several sequences each of which is suited for a certain chord type. Even if you press only one note, the Arpeggio is played back using the programmed sequence—meaning that notes other than the ones you play may be sounded. Pressing another note triggers the transposed sequence regarding the pressed note as a root note. Adding notes to those already held changes the sequence accordingly. An Arpeggio with such a playback type has "_ES" at the end of the type name.

Playback of a programmed sequence according to the played chord type

These Arpeggio types created for use with Normal Voices are played back to match the chord type determined by detecting the notes you play on the keyboard. An Arpeggio with such a playback type has "_XS" at the end of the type name.

NOTE When the Key Mode parameter is set to "sort" or "sort+direct," the same sequence is played back no matter what order you play the notes. When the Key Mode parameter is set to "thru" or "thru+direct," a different sequence is played back depending on the order you play the notes.

NOTE Since these types are programmed for Normal Voices, using them with Drum Voices may not give musically appropriate results.

Arpeggio Types for Drum Voices (Category: DrPc)

These arpeggio types are programmed specifically for use with Drum Voices, giving you instant access to various rhythm patterns. Three different playback types are available.

Playback of a drum pattern

Pressing any note(s) will trigger the same rhythm pattern.

Playback of a drum pattern, plus additional played notes (assigned drum instruments)

Pressing any note will trigger the same rhythm pattern. Adding notes to the one already held produces additional sounds (assigned drum instruments) for the drum pattern.

Playback only of the played notes (assigned drum instruments)

Playing a note or notes will trigger a rhythm pattern using only the notes played (assigned drum instruments). Keep in mind that even if you play the same notes, the triggered rhythm pattern differs depending on the order of the notes played. This gives you access to different rhythm patterns using the same instruments simply by changing the order in which you play the notes when the Key Mode parameter is set to “thru” or “thru+direct.”

NOTE The three playback types above are not distinguished by category name or type name. You'll have to actually play the types and hear the difference.

NOTE Since these types are programmed for Drum Voices, using them with Normal Voices may not give musically appropriate results.

Arpeggio Types containing mainly non-note events (Category: Cntr)

These arpeggio types are programmed primarily with Control Change and Pitch Bend data. They are used to change the tone or pitch of the sound, rather than play specific notes. In fact, some types contain no note data at all. When using a type of this category, set the Key Mode parameter to “direct,” “thru+direct,” or “sort+direct.”

NOTE The Key Mode parameter can be set in the Arp Edit display (pages 66 and 96) of Voice Common Edit and Multi Part Edit.

Tips for Arpeggio playback

The Arpeggio function is useful for creating original songs as well as a creative aid in your live performance, allowing you to automatically trigger high-quality MIDI sequence phrases that match the selected Voice or your desired music genre. For details about how to use this function, refer to page 40 in the Quick Guide section.

Controller Block

This block generates the MIDI events then transmits them to the tone generator block.

On synthesizers such as the MOTIF XS, this block consists of the keyboard, Pitch Bend and Modulation Wheels, Ribbon Controller, Knobs, Sliders and panel buttons. On the MOTIF-RACK XS, this block consists of only the five knobs and panel buttons. Controlling the knobs while playing the external MIDI keyboard adjusts the Voice parameters such as tonal characteristics and volume in real time. For details on using knobs, see page 29 in the Quick Guide section.

Effect Block

This block applies effects to the output of the tone generator block, and audio input block, processing and enhancing the sound. Effects are applied in the final stages of editing, letting you change the sound of the created Voice as desired.

Effect structure

System Effects—Reverb and Chorus

System Effects are applied to the overall sound. With System Effects, the sound of each Part is sent to the effect according to the effect Send Level for each Part. The processed sound (referred to as “wet”) is sent back to the mixer, according to the Return Level, and output—after being mixed with the unprocessed “dry” sound. This arrangement lets you prepare an optimum balance of the effect sound and the original sound of the Parts.

Insertion Effect

Insertion Effects can be applied individually to each Part. Insertion Effects are mainly used to directly process a single Part, or Voice. A insertion effect has two units, A and B. Different effect types can be set for each unit (Insertion Effects A and B). The Insertion Effect can be specified in the effect parameter display of Voice Edit (page 72). This instrument features eight sets of Insertion Effects (each set has two units, A and B). They can be applied to a maximum of eight Parts in the Multi mode.

Master Effect

This block applies effects to the final stereo output signal of the entire sound.

Element EQ

The Element EQ is applied to each element of the Normal Voice and each key of the Drum Voice. You can specify which shape is used among five types, such as shelving and peaking. The Element EQ parameters can be set only on the MOTIF-RACK XS Editor.

Common EQ/Part EQ

The Part EQ, the 3-band parametric EQ, is applied to each part of the Multi. The high band and low band are the shelving type. The middle band is the peaking type. The Common EQ parameters offset the settings of the Part EQ parameters.

Master EQ

Master EQ is applied to the final (post-effect), overall sound of the instrument. In this EQ, all five bands can be set to peaking, or the lowest and highest bands can also be set to shelving.

Effect connection in each mode

In the Voice mode

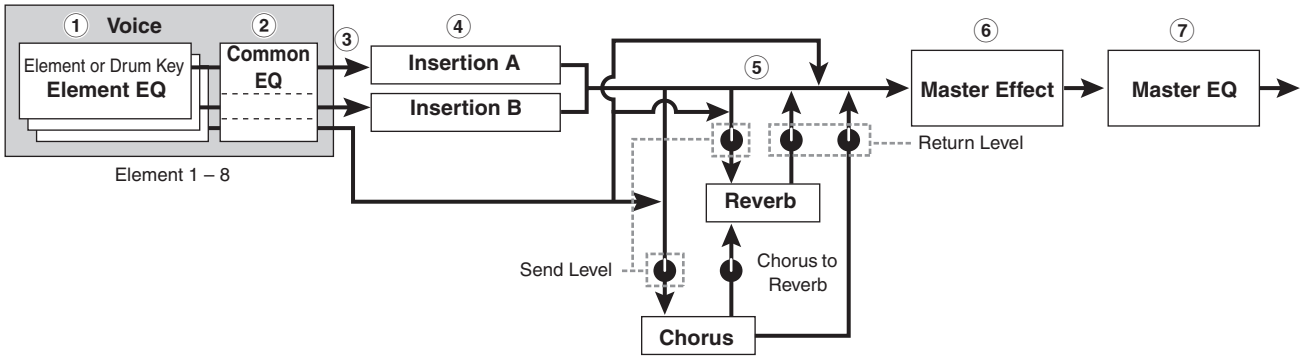

- ① **Element EQ applied to each Element (for a Normal Voice) and each Key (for a Drum Voice)**
Can be set on the MOTIF-RACK XS Editor. See pages 81 and 86.
- ② **Common EQ applied to all the Elements and Keys**
Can be set in the 3 Band EQ display (page 71) of Voice Common Edit.
- ③ **Selection which Insertion Effect, A or B is applied to each Element/Key**
Can be set on the MOTIF-RACK XS Editor. See page 72.

- ④ **Insertion Effect A/B related parameters**
Can be set in the Effect Parameter display (page 72) for "Ins A" and "Ins B" of Voice Common Edit.
- ⑤ **Reverb and Chorus related parameters**
Can be set in the Effect Parameter display (page 72) for "Reverb" and "Chorus" of Voice Common Edit.
- ⑥ **Master Effect related parameters**
Can be set in the Voice MEF window (page 102) of Utility.
- ⑦ **Master EQ related parameters**
Can be set in the Voice MEQ window (page 103) of Utility.

NOTE Regarding the Audio Input signal from the mLAN terminal in the Voice mode, when the "Output Select" parameter (page 102) is set to something other than "L&R," the signal can be applied at only ① - ④ settings as shown above and output.

In the Multi mode

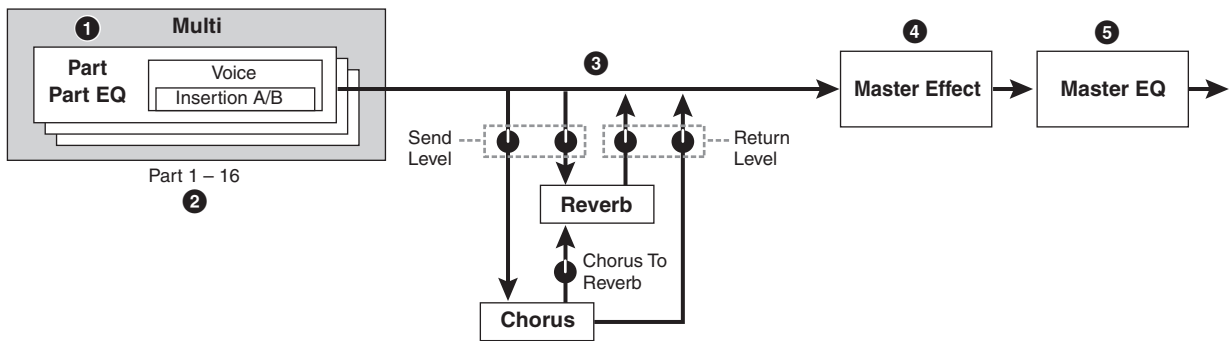

- ① **Part EQ applied to each Part**
Can be set in the Part EQ display (page 96) of Multi Part Edit.
- ② **Selection to which Parts the Insertion Effect is applied**
Can be set in the Fx Send display (page 97) of the Multi Part Edit and the Effect display of Multi Common Edit on the MOTIF-RACK XS Editor.
- ③ **Reverb and Chorus related parameters**
Can be set in the Effect Parameter display (page 93) for "Reverb" and "Chorus" of Multi Common Edit and the Fx Send display (page 97) of Multi Part Edit.

- ④ **Master Effect related parameters**
Can be set in the Effect Parameter display (page 93) for "Master" of Multi Common Edit.
 - ⑤ **Master EQ related parameters**
Can be set in the MEQ display (page 92) of Multi Common Edit.
- NOTE** The Effect settings of ①, ③, and ④ in the Voice mode illustrated on page 58 are available for up to eight parts for which the Insertion Effect is turned on.
- NOTE** The audio signals of the parts for which the "Output Select" parameter (page 95) is set to something other than "L&R" can be applied only at the ① and ② settings as shown above and output.

Effect Types divided into Effect Categories

The MOTIF-RACK XS provides such a wide and extensive variety of Effect types that it may be difficult to find the desired Effect type out of the great number that are available. This is why all the Effect types are divided into convenient Effect categories. This section explains the Effect categories and their types. The Effect Type list described below for each category contains the columns: Rev (Reverb), Cho (Chorus), Ins (Insertion) and Mas (Master Effect). The checkmarks indicated in these columns means the Effect Type is available for each block. These Effect types (with the checkmarks indicated in each list) can be selected from the panel controls.

Reverb

Also called “reverberation,” this refers to the sound energy remaining in a room or closed space after the original sound stops. Similar to yet different from echo, reverb is the indirect, diffuse sound of reflections from the walls and ceiling that accompany the direct sound. The characteristics of this indirect sound depends on the size of the room or space and the materials and furnishings in the room. Reverb Effect types use digital signal processing to simulate these characteristics.

Effect Type	Rev	Cho	Ins	Description
REV-X HALL	✓	–	–	Reverb emulating the acoustics of a concert hall using REV-X technology.
R3 HALL	✓	–	–	Reverb emulating the acoustics of a concert hall using an algorithm derived from the Yamaha ProR3.
SPX HALL	✓	✓	✓	Reverb emulating the acoustics of a concert hall derived from the Yamaha SPX1000.
REV-X ROOM	✓	–	–	Reverb emulating the acoustics of a room using the REV-X technology.
R3 ROOM	✓	–	–	Reverb emulating the acoustics of a room using an algorithm derived from the Yamaha ProR3.
SPX ROOM	✓	✓	✓	Reverb emulating the acoustics of a room derived from the Yamaha SPX1000.
R3 PLATE	✓	–	–	Reverb emulating a metal plate using an algorithm derived from the Yamaha ProR3.
SPX STAGE	✓	✓	✓	Reverb designed for enhancing solo instruments, derived from the Yamaha SPX1000.
SPACE SIMULATOR	✓	–	–	Reverb which lets you set the space size by specifying the width, height, and depth.

Delay

An effect (or device) that delays an audio signal for ambient or rhythmic effects.

Effect Type	Rev	Ins	Mas	Description
CROSS DELAY	✓	✓	–	The feedback of the two delayed sounds is crossed.

Effect Type	Rev	Ins	Mas	Description
TEMPOCROSS DELAY	✓	✓	–	Cross delay synchronized with the tempo.
TEMPO DELAY MONO	✓	✓	–	Mono delay synchronized with the tempo.
TEMPO DELAY STEREO	✓	✓	–	Mono delay synchronized with the tempo.
CONTROL DELAY	–	✓	–	Delay with delay time controllable in real time.
DELAY LR	✓	✓	–	Produces two delayed sounds: L and R.
DELAY LCR	✓	✓	–	Produces three delayed sounds: L, R and C (center).
DELAY LR (Stereo)	✓	✓	✓	Produces two delayed sounds in stereo: L and R.

Chorus

Depending on the particular chorus type and parameters, this can make a voice sound “larger,” as if several identical instruments were playing in unison, or it can give a voice greater warmth and depth.

Effect Type	Cho	Ins	Description
G CHORUS	✓	✓	This chorus effect produces a richer and more complex modulation than conventional chorus.
2 MODULATOR	✓	✓	This chorus effect consists of pitch modulation and amplitude modulation.
SPX CHORUS	✓	✓	This effect uses a 3-phase LFO to add modulation and spaciousness to the sound.
SYMPHONIC	✓	✓	A multi-stage version of SPX CHORUS modulation.
ENSEMBLE DETUNE	✓	✓	Chorus effect without modulation, created by adding a slightly pitch-shifted sound.

Flanger

This effect creates a swirling, metallic sound.

Effect Type	Cho	Ins	Description
VCM FLANGER	✓	✓	Flanger with VCM technology producing a vintage sound.
CLASSIC FLANGER	✓	✓	Conventional type of flanger.
TEMPO FLANGER	✓	✓	Tempo-synchronized flanger.
DYNAMIC FLANGER	–	✓	Dynamically controlled flanger.

Phaser

Cyclically modulates the phase to add modulation to the sound.

Effect Type	Cho	Ins	Description
VCM PHASER MONO	✓	✓	Mono phaser with VCM technology producing a vintage sound.
VCM PHASER STEREO	✓	✓	Stereo phaser with VCM technology producing a vintage sound.
TEMPO PHASER	✓	✓	Tempo-synchronized phaser.
DYNAMIC PHASER	–	✓	Dynamically controlled phase shifter.

Tremolo & Rotary

The tremolo effect cyclically modulates the volume. The Rotary Speaker effect simulates the characteristic vibrato effect of a rotary speaker.

Effect Type	Ins	Description
AUTO PAN	✓	An effect which cyclically moves the sound left/right and front/back.
TREMOLO	✓	An effect which cyclically modulates the volume.
ROTARY SPEAKER	✓	Simulation of a rotary speaker.

Distortion

This type can be used mainly for guitar, adding distortion with an edge to the sound.

Effect Type	Ins	Mas	Description
AMP SIMULATOR 1	✓	–	A simulation of a guitar amp.
AMP SIMULATOR 2	✓	–	A simulation of a guitar amp.
COMP DISTORTION	✓	–	Since a Compressor is included in the first stage, steady distortion can be produced regardless of changes in input level.
COMP DISTORTION DELAY	✓	✓	Compressor, Distortion and Delay are connected in series.

Compressor

Compressor is an effect commonly used to limit and compress the dynamics (softness/loudness) of an audio signal. For signals that vary widely in dynamics, such as vocals and guitar parts, it “squeezes” the dynamic range, effectively making soft sounds louder and loud sounds softer. When used with gain to boost the overall level, this creates a more powerful, more consistently high-level sound. Compression can be used to increase sustain for electric guitar, smooth out the volume of a vocal, or bring a drum kit or rhythm pattern further up-front in the mix.

Effect Type	Ins	Mas	Description
VCM COMPRESSOR 376	✓	✓	Compressor with VCM technology.
CLASSIC COMPRESSOR	✓	–	Conventional type of compressor.
MULTI BAND COMP	✓	✓	3-band type compressor.

Wah

This Effect cyclically modulates the tone brightness (cutoff frequency of a filter). Auto Wah modulates the tone via LFO, Touch Wah modulates the tone via volume (note on velocity) and Pedal Wah modulates the tone via pedal control (foot controller).

Effect Type	Ins	Description
VCM AUTO WAH	✓	Modulates the tone via the LFO.
VCM TOUCH WAH	✓	Modulates the tone via the volume (note on velocity).
VCM PEDAL WAH	✓	Modulates the tone via the pedal control. For best results, assign the Pedal Control parameter of this Effect type to the Foot Controller in the Controller Set display, then use the Foot Controller to control this effect in real time.

Lo-Fi

This effect intentionally degrades the audio quality of the input signal via several methods, including lowering of the sampling frequency.

Effect Type	Ins	Mas	Description
LO-FI	✓	✓	Degrades the audio quality of the input signal for a lo-fi sound.
NOISY	✓	–	Adds noise to the current sound.
DIGITAL TURNTABLE	✓	–	Simulates the noise, scratches and pops of a vinyl record.

Tech

This effect radically changes the tonal characteristics by using a filter and modulation.

Effect Type	Ins	Mas	Description
RING MODULATOR	✓	✓	An effect that modifies the pitch by applying amplitude modulation to the frequency of the input.
DYNAMIC RING MODULATOR	✓	–	Dynamically controlled ring modulation.
DYNAMIC FILTER	✓	✓	Dynamically controlled filter.
AUTO SYNTH	✓	–	Processes the input signal into a synthesizer-type sound.
ISOLATOR	✓	✓	Controls the level of a specified frequency band of the input signal.
SLICE	✓	✓	Cuts the Voice sound into separate segments for special rhythmic effects.
TECH MODULATION	✓	–	Adds a unique feeling of modulation similar to ring modulation.

MISC

This category includes effect types not included in the other categories.

Effect Type	Cho	Ins	Description
VCM EQ 501	–	✓	Vintage 5-band parametric EQ with VCM technology.
HARMONIC ENHANCER	–	✓	Adds new harmonics to the input signal to make the sound stand out.
TALKING MODULATOR	–	✓	Adds a vowel sound to the input signal.
DAMPER RESONANCE	–	✓	Simulates the resonance produced when the damper pedal of the piano is pressed.
PITCH CHANGE	–	✓	Changes the pitch of the input signal.
EARLY REFLECTION	✓	✓	This effect isolates only the early reflection components of the reverb.

VCM (Virtual Circuitry Modeling)

VCM is a technology that authentically models the elements in analog circuitry (such as resistors and capacitors). Effect types using the VCM technology produce the uniquely warm characteristics of vintage processing gear.

VCM Compressor 376

This effect emulates the characteristics of analog compressors, used as standard effects in recording studios. It frames and thickens the sound, and is suitable for drum and bass sounds.

VCM Equalizer 501

This effect emulates the characteristics of analog equalizers used in 1970s. It adds drive to the sound by reproducing distortion typical of analog circuits. It consists of two shelving-type filters and three peaking-type filters.

VCM Flanger

This effect emulates the characteristics of analog flanger used in the 1970s, recreating a warm, high-quality flanger effect.

VCM Phaser Mono, VCM Phaser Stereo

These effect emulate the characteristics of analog phasers used in the 1970s, recreating a warm, high-quality phaser effect.

VCM Auto Wah, VCM Touch Wah, VCM Pedal Wah

These effects emulate the characteristics of analog Wah used in the 1970s, recreating a warm, high-quality wah-wah effect.

REV-X

REV-X is a reverb algorithm developed by Yamaha. It provides a high-density, richly reverberant sound quality, with smooth attenuation, spread and depth that work together to enhance the original sound. The MOTIF-RACK XS features two types of REV-X effects: REV-X Hall and REV-X Room.

Effect Parameters

Each of the Effect Types has parameters that determine how the Effect is applied to the sound. A variety of sounds can be obtained from a single effect type by setting these parameters. For information about the Effect parameters, see below.

Preset settings for Effect parameters

Preset settings for parameters of each effect type are provided as templates and can be selected by the "Preset" parameter in the Effect Type selection display. To get a desired effect sound, try first selecting one of the Presets close to your imagined sound, then change the parameters as necessary. For details about the preset settings of each effect type, refer to the separate Data List booklet.

Effect parameters

Effect Parameters making up the affect of the Effect Type are listed here in alphabetical order.

NOTE Each name of the parameters listed below is indicated with its full or complete spelling, although it is indicated with the abbreviated spelling on the LCD. The discrepancy in the name may make it difficult to find the desired parameter. In such a case, confirm the parameters belonging to the Effect Type you want to edit by referring to the Effect Parameter List in the separate Data List booklet.

NOTE Some parameters below may appear in different effect types with the same name, but actually have different functions depending on the particular effect type. For these parameters, two or three types of explanations are given.

Parameter name	Description
AEG Phase	Offsets the phase of the AEG.
AM Depth	Determines the depth of the amplitude modulation.
AM Inverse R	Determines the phase of the amplitude modulation for the R channel.
AM Speed	Determines the amplitude modulation speed.
AM Wave	Determines the wave of the amplitude modulation.
AMP Type	Selects the amplifier type to be simulated.
Analog Feel	Adds the characteristics of an analog flanger to the sound.
Attack	Determines the amount of time that elapses between the playing of a key and the start of the compressor effect.
Attack Offset	Determines the amount of time that elapses between the playing of a key and the start of the wah effect.
Attack Time	Determines the attack time of the envelope follower.
Bit Assign	Determines how the Word Length is applied to the sound.
Bottom ¹	Determines the minimum value of the wah filter.
Click Density	Determines the frequency at which the click sounds.
Click Level	Determines the click level.
Color ²	Determines the fixed phase modulation.
Common Release	This is a parameter of "Multi Band Comp." This parameter determines the amount of time that elapses between the releasing of a note and the end of the effect.
Compress	Determines the minimum input level at which the compressor effect is applied.
Control Type	This is a parameter of "Control Delay." When set to "Normal," the delay effect is always applied to the sound. When set to "Scratch," the delay effect is not applied if both the Delay Time and Delay Time Offset are set to "0."
Damper Control	When the half-damper compatible FC3 footswitch is connected to the SUSTAIN jack, the Damper Control parameter is controlled by the FC3 over a range of 0 – 127, allowing for partial damper effects, such as is available on an actual grand piano.
Decay	Controls how the reverb sound decays.
Delay Level C	Determines the level of the delayed sound for the center channel.
Delay Mix	Determines the level of the delayed mixed sound when multiple effects are applied.
Delay Offset	Determines the offset value of the delay modulation.
Delay Time	Determines the delay of the sound in note value or absolute time.
Delay Time C, L, R	Determines the delay time for each channel: center, left and right.
Delay Time L>R	Determines the amount of time between the moment the sound is input from the L channel and the moment the sound is output to the R channel.
Delay Time Ofst R	Determines the delay time for the R channel as offset.
Delay Time R>L	Determines the amount of time between the moment the sound is input from the R channel and the moment the sound is output to the L channel.
Delay Transition Rate	Determines the speed (rate) at which the delay time is changed from the current value to the specified new value.
Density	When the Reverb effect is selected, this determines the density of the reverberations. When the Early Reflection is selected, this determines the density of the reflections.
Depth	When "Space Simulator" is selected, this parameter determines the depth of the simulated room. When "VCM Flanger" is selected, this parameter determines the amplitude of the LFO wave which controls the cyclic change of the delay modulation. When the phaser type is selected, this parameter determines the amplitude of the LFO wave which controls the cyclic change of the phase modulation.
Detune	Determines the amount of pitch to be detuned.

The Controls & Connectors

Setting Up

Listening to the Sound

Connections

Using a Computer

Quick Guide

Basic Structure

Voice

Multi

Utility

Appendix

Parameter name	Description
Device	Selects the device for changing how to distort the sound.
Diffusion	Determines the spread of the selected effect.
Direction	Determines the direction of the modulation controlled by the envelope follower.
Divide Freq High	Determines the high frequency for dividing the entire sound into three bands.
Divide Freq Low	Determines the low frequency for dividing the entire sound into three bands.
Divide Min Level	Determines the minimum level of the portions extracted via the slice effect.
Divide Type	Determines how the sound (wave) is sliced by the note length.
Drive	When one of the distortion, noisy and slice effects is selected, this parameter determines the extent to which the sound is distorted. When one of the misc effects is selected, this parameter determines the extent to which the enhancer is applied.
Drive Horn	Determines the depth of the modulation generated via the rotation of the horn.
Drive Rotor	Determines the depth of the modulation generated via the rotation of the rotor.
Dry Level	Determines the level of the dry sound (to which the effect is not applied).
Dry LPF Cutoff Frequency	Determines the cutoff frequency of the low pass filter applied to the dry sound.
Dry Mix Level	Determines the level of the dry sound (to which the effect is not applied).
Dry Send to Noise	Determines the level of the dry signal sent to the noise effect.
Dry/Wet Balance	Determines the balance of the dry sound and effect sound.
Dyna Level Offset	Determines the offset value added to the output from the envelope follower.
Dyna Threshold Level	Determines the minimum level at which the envelope follower starts.
Edge	Sets the curve that determines how the sound is distorted.
Emphasis	Determines the change of the characteristics in high frequencies.
EQ Frequency	Determines the center frequency for each band of the EQ.
EQ Gain	Determines the level gain of the EQ center frequency for each band.
EQ High Frequency	Determines the center frequency of the high EQ band that is attenuated/boosted.
EQ High Gain	Determines the amount of boost or attenuation applied to the high EQ band.
EQ Low Frequency	Determines the center frequency of the low EQ band that is attenuated/boosted.
EQ Low Gain	Determines the amount of boost or attenuation applied to the low EQ band.
EQ Mid Frequency	Determines the center frequency of the middle EQ band that is attenuated/boosted.
EQ Mid Gain	Determines the amount of boost or attenuation applied to the middle EQ band.
EQ Mid Width	Determines the width of the middle EQ band.
EQ Width	Determines the width of the EQ band.
ER/Rev Balance	Determines the level balance of the early reflection and reverb sound.
F/R Depth	This parameter of "Auto Pan" (available when PAN Direction is set to "L turn" and "R turn") determines the depth of the F/R (front/rear) pan.
FB Hi Damp Ofst R	Determines the amount of decay in high frequencies for the R channel as offset.
FB Level Ofst R	Determines the feedback level for the R channel as offset.
Feedback	Determines the level of the sound signal output from the effect block and returned to its own input.
Feedback High Damp	Determines how the high frequencies of the feedback sound decay.
Feedback Level	When one of the reverb and early reflection effects is selected, this parameter determines the feedback level of the initial delay. When one of the delay, chorus, flanger, comp distortion delay, and TEC effects is selected, this parameter determines the feedback level output from the delay and returned to the input. When "Tempo Phaser" or "Dynamic Phaser" is selected, this parameter determines the feedback level output from the phaser and returned to the input.
Feedback Level 1, 2	Determines the feedback level of the delayed sound in each of the 1st and 2nd series.
Feedback Time	Determines the delay time of the feedback.
Feedback Time 1, 2, L, R	Determines the time of the feedback delay 1, 2, L and R.

Parameter name	Description
Filter Type	When "Lo-Fi" is selected, this parameter selects the tonal characteristic type. When "Dynamic Filter" is selected, this parameter determines the filter type.
Fine 1, 2	Determines the pitch finely for each of the 1st series and 2nd series.
Gate Time	Determines the gate time of the sliced portion.
Height	Determines the height of the simulated room.
Hi Resonance	Adjusts the resonance of the high frequencies.
High Attack	Determines the amount of time from the moment a note is pressed to the moment the compressor is applied to the high frequencies.
High Gain	Determines the output gain for the high frequencies.
High Level	Determines the level of the high frequencies.
High Mute	Switches the mute status of the high frequencies.
High Ratio	When "REV-X Hall" or "REV-X Room" is selected, this parameter determines the ratio of the high frequencies. When "Multi Band Comp" is selected, this parameter determines the ratio of the compressor for the high frequencies.
High Threshold	Determines the minimum input level at which the effect is applied to the high frequencies.
Horn Speed Fast	Determines the speed of the horn when the slow/fast switch is set to "fast."
Horn Speed Slow	Determines the speed of the horn when the slow/fast switch is set to "slow."
Initial Delay	Determines the amount of time that elapses between the direct, original sound and the initial reflections.
Initial Delay 1, 2	Determines the delay time until the initial reflection for each of the 1st series and 2nd series.
Initial Delay Lch, Rch	Determines the amount of time that elapses between the direct, original sound and the initial reflections (echoes) that follow it for each of R and L channels.
Input Level	Determines the input level of the signal to which the compressor is applied.
Input Mode	Selects mono or stereo configuration for the input sound.
Input Select	Selects an input channel.
L/R Depth	Determines the depth of the L/R pan effect.
L/R Diffusion	Determines the spread of the sound.
Lag	Determines the lagging time additionally applied to the delayed sound specified via a note length.
LFO Depth	When one of "SPX Chorus," "Symphonic," "Classic Flanger," and "Ring Modulator" is selected, this parameter determines the depth of the modulation. When "Tempo Phase" is selected, this parameter determines the frequency of the phase modulation.
LFO Phase Difference	Determines the L/R phase difference of the modulated wave.
LFO Phase Reset	Determines how to reset the initial phase of the LFO.
LFO Speed	When one of the chorus effects, flanger effects, tremolo and ring modulator is selected, this parameter determines the frequency of the modulation. When "Tempo Phaser" is selected, this parameter determines the modulation speed via a note type. When "Auto Pan" is selected, this parameter determines the frequency of the Auto Pan.
LFO Wave	When any of the flanger effects or "Ring Modulator" is selected, this parameter selects the wave for modulation. When "Auto Pan" is selected, this parameter determines the panning curve. When "VCM Auto Wah" is selected, this parameter selects the wave, sine or square.
Liveness	Determines the decay characteristic of Early Reflection.
Low Attack	Determines the amount of time from the moment a note is pressed to the moment the compressor is applied to the low frequencies.
Low Gain	Determines the output gain for the low frequencies.
Low Level	Determines the output level for the low frequencies.
Low Mute	Determines whether the low frequency band is off or on.
Low Ratio	When "REV-X Hall" or "REV-X Room" is selected, this parameter determines the ratio of the low frequencies. When "Multi Band Comp" is selected, this parameter determines the ratio of the compressor for the low frequencies.
Low Threshold	Determines the minimum input level at which the effect is applied to the low frequencies.
LPF Resonance	Determines the resonance of the low pass filter for the input sound.

Parameter name	Description
Manual	When "VCM Flanger" is selected, this parameter determines the offset value of the delay modulation.
	When "VCM Phaser mono" or "VCM Phaser stereo" is selected, this parameter determines the offset value of the phase modulation.
Meter	Changes the meter.
Mic L-R Angle	Determines the L/R angle of the microphone.
Mid Attack	Determines the amount of time from the moment a note is pressed to the moment the compressor is applied to the mid frequencies.
Mid Gain	Determines the output gain for the mid frequencies.
Mid Level	Determines the output level for the mid frequencies.
Mid Mute	Switches the mute status of the mid frequencies.
Mid Ratio	Determines the ratio of the compressor for the mid frequencies.
Mid Threshold	Determines the minimum input level at which the effect is applied for the mid frequencies.
Mix	Determines the volume of the effect sound.
Mix Level	Determines the level of the effect sound mixed to the dry sound.
Mod Depth	Determines the depth of the modulation.
Mod Depth Ofst R	Determines the depth of the modulation for R channel as offset.
Mod Feedback	Determines the feedback level for the modulation.
Mod Gain	Determines the gain of the modulation.
Mod LPF Cutoff Frequency	Determines the cutoff frequency of the low pass filter applied to the modulated sound.
Mod LPF Resonance	Determines the resonance of the low pass filter for the modulated Sound.
Mod Mix Balance	When "Noisy" is selected, this parameter determines the mix level of the modulated element.
	When "Tech Modulation" is selected, this parameter determines the volume of the modulated sound.
Mod Speed	Determines the modulation speed.
Mod Wave Type	Selects the wave type for modulation.
Mode	Determines the phaser type, or more specifically, the factor for forming the phaser effect.
Modulation Phase	Determines the L/R phase difference of the modulated wave.
Move Speed	Determines how long it takes to move the sound from the current status to the sound specified via the Vowel parameter.
Noise Level	Determines the noise level.
Noise LPF Cutoff Frequency	Determines the cutoff frequency of the low pass filter applied to the noise.
Noise LPF Q	Determines the resonance of the low pass filter applied to the noise.
Noise Mod Depth	Determines the depth of the noise modulation.
Noise Mod Speed	Determines the speed of the noise modulation.
Noise Tone	Determines the characteristics of the noise.
On/Off Switch	Turns the isolator on or off.
OSC Frequency Coarse	Determines the frequency at which the sine wave modulates the amplitude of the input wave.
OSC Frequency Fine	Determines the frequency finely at which the sine wave modulates the amplitude of the input wave.
Output	Determines the level of the signal output from the effect block.
Output Gain	
Output Level	
Output Level 1, 2	Determines the level of the signal output from the 1st block and 2nd block respectively.
Over Drive	Determines the degree and character of the distortion effect.
Pan 1, 2	Determines the pan for each of the 1st series and 2nd series.
Pan AEG Min Level	This parameter of the Slice effect determines the minimum level of the AEG applied to the panned sound.
Pan AEG Type	This parameter of the Slice effect determines the type of the AEG applied to the panned sound.
Pan Depth	Determines the depth of the pan effect.
Pan Direction	Determines the direction toward which the stereo pan position of the sound moves.
Pan Type	Determines the pan type.
Pedal Control	When "VCM PEDAL WAH" is selected, this parameter determines the cutoff frequency of the wah filter. For best results, assign this parameter to the Foot Controller in the Controller Set display, then use the Foot Controller to control this parameter.
Pedal Response	Determines how the sound responds to the change of the damper control.
Phase Shift Offset	Determines the offset value of the phase modulation.

Parameter name	Description
Pitch 1, 2	Determines the pitch in semitones for each of the 1st series and 2nd series.
PM Depth	Determines the depth of the pitch modulation.
Pre Mod HPF Cutoff Frequency	Determines the Cutoff frequency of the High Pass Filter before the modulation.
Pre-LPF Cutoff Frequency	Determines the Cutoff frequency of the Low Pass Filter before the modulation.
Pre-LPF Resonance	Determines the Resonance of the Low Pass Filter for the input sound.
Presence	This parameter of the guitar amp effect controls high frequencies.
Ratio	Determines the ratio of the compressor.
Release	Determines the amount of time that elapses between the releasing of a key and the end of the compressor effect.
Release Curve	Determines the release curve of the envelope follower.
Release Time	Determines the release time of the envelope follower.
Resonance	Determines the resonance of the filter.
Resonance Offset	Determines the resonance as offset.
Reverb Delay	Determines the delay time from the early reflections until the reverberations.
Reverb Time	Determines the reverb time.
Room Size	Determines the size of the room in which the instrument sounds.
Rotor Speed Fast	Determines the speed of the rotor when the slow/fast switch is set to "fast."
Rotor Speed Slow	Determines the speed of the rotor when the slow/fast switch is set to "slow."
Rotor/Horn Balance	Determines the volume balance of the horn and rotor.
Sampling Freq. Control	Controls the sampling frequency.
Sensitivity	When one of "Dynamic Flanger," "Dynamic Phaser," and the TEC effects is selected, this parameter determines the sensitivity of the modulation applied to the input change.
	When one of the VCM Touch Wah effects is selected, this parameter determines the sensitivity of the wah filter's change applied to the input change.
Slow-Fast Time of Horn	Determines how long it takes for the rotation speed of the horn to change from the current speed (slow or fast) to the other one (fast or slow) when the rotation speed is switched.
Slow-Fast Time of Rotor	Determines how long it takes for the rotation speed of the rotor to change from the current speed (slow or fast) to the other one (fast or slow) when the rotation speed is switched.
Space Type	Selects the type of space simulation.
Speaker Type	When "VCM Auto Wah" is selected, this parameter determines the speed of the LFO.
Speed	When "VCM Flanger" is selected, this parameter determines the frequency of the LFO wave which controls the cyclic change of the delay modulation.
	When any of the phaser types is selected, this parameter determines the frequency of the LFO wave which controls the cyclic change of the phase modulation.
	When "VCM Auto Wah" is selected, this parameter determines the speed of the LFO.
Speed Control	Switches the rotary speed.
Spread	Determines the spread of the sound.
Stage	Determines the step number of the phase shifter.
Threshold	Determines the minimum input level at which the effect is applied.
Top ³	Determines the maximum value of the wah filter.
Type	When "VCM Flanger" is selected, this parameter determines the flanger type.
	When any of the wah effects is selected, this parameter determines the type of the Auto Wah.
	When "Early Reflection" is selected, this parameter determines the type of the reflection sound.
Vowel	Selects a vowel type.
Wall Vary	Determines the wall status of the simulated room. Higher settings produces more diffuse reflections.
Width	Determines the width of the simulated room.
Word Length	Determines the degree of sound roughness.

*1 The Bottom parameter is available only when the value is less than that of the Top parameter.
 *2 The Color parameter may not be effective depending on the values of the Mode and Stage parameters.
 *3 The Top parameter is available only when the value is more than that of the Bottom parameter.

The Controls & Connectors
Setting Up
Listening to the Sound
Connections
Using a Computer
Quick Guide
Basic Structure
Voice
Reference
Multi
Utility
Appendix

Reference

This section of the manual covers in detail all of the parameters and settings available on the MOTIF-RACK XS and the MOTIF-RACK XS Editor. Some Common Edit parameters and all Element/Key Edit parameters can only be edited in the MOTIF-RACK XS Editor. When the editing is synchronized between the MOTIF-RACK XS Editor and the MOTIF-RACK XS instrument, editing a parameter on the MOTIF-RACK XS Editor affects the same parameter on the MOTIF-RACK XS instrument and vice versa. In other words, any editing you do on either the software Editor or the hardware is automatically reflected on both. This provides a smooth, seamless interface, and makes it very easy to create and edit your data. For details about how to synchronize data between the two, refer to the owner's manual of the MOTIF-RACK XS Editor.

For detailed instructions on accessing each Edit display, refer to page 25 of the Quick Guide.

About the **EDITOR** marks

In the Reference section, the parameters shown in only the MOTIF-RACK XS Editor are marked with **EDITOR** marks.

How to use the Edit display

(Example)

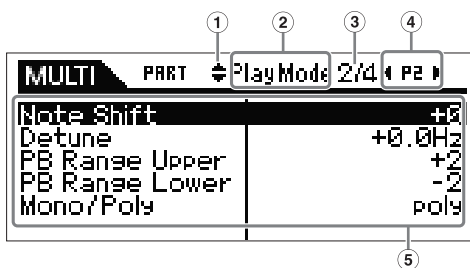

- ① These marks mean that up (▲) or down (▼) additional hidden pages. The next or previous page is displayed by pressing the Cursor [▲]/[▼] buttons to move the cursor in the display.
- ② This indicates the name of the Edit display that is currently selected for your edit operations.
- ③ This number means the currently displayed page number of the selected Edit display. For example, the symbol "2/4" indicates that the currently selected Edit display has four pages, and the second page is displayed.
- ④ (Multi mode only) This indicates the currently selected part. When left indicator (◀)/right indicator (▶) are displayed, you can change the part with the Cursor [◀]/[▶] buttons.
- ⑤ The currently editable parameters are displayed. You can select the desired parameter for editing by using the Cursor [▲]/[▼]/[◀]/[▶] buttons and change the settings with the Encoders.

Voice Mode

Normal Voice Edit

A Normal Voice, which contains pitched musical instrument-type sounds that can be played over the range of a keyboard, can consist of up to eight Elements. There are two types of Normal Voice Edit displays: those for Common Edit to edit the settings common to all Elements, and those for Element Edit to edit individual Elements.

In this section, we'll cover the Normal Voice parameters.

Common Edit

These parameters are for making global (or common) edits to all eight Elements of the selected Normal Voice.

Procedure

[VOICE] → select Normal Voice → [EDIT] → select the desired display in the Voice Edit Select display → [ENTER] → Edit display

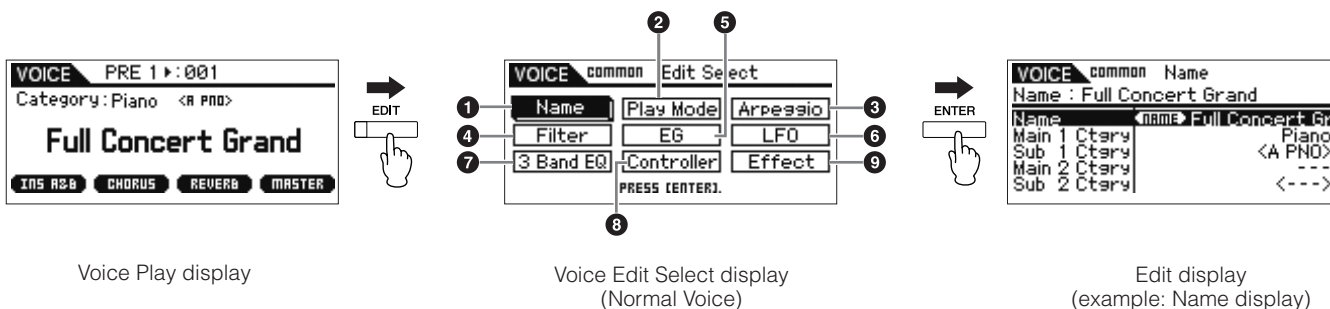

1 Name	
Name	Enters the desired name for the Voice. When you move the cursor to "Name," pressing the [ENTER] button calls up the Naming dialog, allowing you to enter the desired name. The Voice name can contain up to 20 characters. For detailed instructions on naming, refer to page 47 in the Quick Guide.
Main 1 Ctgry (Main Category 1)	Determines the two Main Categories and their Sub Categories to which the Voice belongs respectively. "Category" can be used as a keyword representing the characteristics of the Voice. The appropriate setting makes it easy to find the desired Voice from a variety of Voices. There are 16 Main Categories which indicate types of instruments. There are up to five Sub Categories for each Main Category, indicating more detailed types of instruments. Settings: Refer to the Category List on page 87.
Sub 1 Ctgry (Sub Category 1)	
Main 2 Ctgry (Main Category 2)	
Sub 2 Ctgry (Sub Category 2)	
2 Play Mode	
Volume	Determines the output level of the Voice. Set this parameter to adjust the balance between the current Voice and other Voices. This parameter can be changed directly via the Knob. Settings: 0 – 127
Pan	Determines the stereo pan position of the Voice. This parameter can be changed directly via the Knob. Settings: L63 (far left) – C (center) – R63 (far right) NOTE Note that this Part Pan parameter may have little or no audible effect if the Pan for a specific Element is set to the left position and the Pan for another Element is set to the right position.
Note Shift	Determines the transpose setting for the amount (in semitones) by which the pitch is raised or lowered. Settings: 24 – +0 – +24
PB Range Upper (Pitch Bend Range Upper)	Determines the maximum Pitch Bend range in semitones. Setting the Upper parameter to +12 would result in a maximum pitch rise of one octave when the Pitch Bend wheel is moved upwards. On the other hand, a Lower setting of -12 would result in the pitch being lowered up to a maximum of one octave (12 semitones) when the Pitch Bend wheel is moved downwards. Settings: -48 semi – +0 semi – +24 semi
PB Range Lower (Pitch Bend Range Lower)	
Mono/Poly	Determines the playback method of the Voice: monophonic (single Note Only) or polyphonic (multiple notes). Settings: mono, poly mono When set to "mono," the selected Voice is played back monophonically (only a single note is played back simultaneously). For many instrument sounds (such as bass and synth lead), this allows a more natural and smooth sounding legato performance than when this parameter is set to "poly." poly..... When set to "poly," the selected Voice is played back polyphonically (multiple notes can be played back simultaneously or a chord is played back).
Key Assign Mode	This is useful when two or more instances of the same note are received nearly simultaneously, or without a corresponding Note Off message. Settings: single, multi single..... When this is set to "single" and double playback of the same note are transmitted to the internal tone generator, the first note will be stopped then the next note will be sounded. multi..... When this is set to "multi" and double playback of the same note are transmitted to the internal tone generator, all the notes are sounded simultaneously.
Porta Sw (Portamento Switch)	Determines whether Portamento is applied to the current Voice or not. This parameter can be changed directly via the Knob. Settings: off, on
Porta Time (Portamento Time)	Determines the pitch transition time when Portamento is applied. The effect of the parameter differs depending on the settings of the "Portamento Time Mode." Higher values result in a longer pitch change time, or a slow speed. This parameter can be changed directly via the Knob. Settings: 0 – 127
Porta Mode (Portamento Mode)	Determines how Portamento is applied to your keyboard performance. Settings: fingered, fulltime fingered Portamento is only applied when you play legato (playing the next note before releasing the previous one). fulltime Portamento is applied to all notes.
Porta Time Mode (Portamento Time Mode)	Determines how the pitch changes in time. Settings: rate1, time1, rate2, time2 rate1 Pitch changes at the specified rate. time1..... Pitch changes in the specified time. rate2 Pitch changes at the specified rate within an octave. time2..... Pitch changes in the specified time within an octave.

The Controls & Connectors
Setting Up
Listening to the Sound
Connections
Using a Computer
Quick Guide
Basic Structure
Voice
Reference
Multi
Utility
Appendix

<p>Porta Lgt Slope (Portamento Legato Slope)</p>	<p>When the Mono/Poly is set to "mono," legato playing may produce an unnatural attack depending on the waveform assigned to the selected Voice. To solve such a problem, you can use this parameter to adjust the attack of the Voice. Normally, this should be set to a low value for waveforms with short attack times, and should be set to a high value for waveforms with long attack times. Settings: 0 – 7</p>
<p>Micro Tune Bank (Micro Tuning Bank)</p>	<p>Determines the Micro Tuning Bank. Settings: preset, user preset Contains the 13 preset Micro Tuning types. user Contains your original Micro Tuning types created in the Micro Tune display (page 102) of the Utility mode.</p>
<p>Micro Tune No. (Micro Tuning Number)</p>	<p>Determines the Micro Tuning number. The Preset Bank provides 13 types, including equal temperament, which is the most commonly used tuning system. For details about Micro Tuning, refer to the "Micro Tuning" (page 87) section in the Supplementary information. Settings: Preset Bank: 1 – 13 (See the Micro Tuning list on page 87) User Bank: 1 – 8</p>
<p>Micro Tune Root (Micro Tuning Root)</p>	<p>Sets the base note for each scale. For some scales this setting may not be necessary. Settings: C – B</p>
<p>Audition No. (Audition Phrase Number)</p>	<p>Selects the type of the Audition phrase. Settings: 001 – 285</p>
<p>Audition Note Shift (Audition Phrase Note Shift)</p>	<p>Adjusts the pitch in semitone increments. Settings: -24 – +0 – +24</p>
<p>Audition Vel Shift (Audition Phrase Velocity Shift)</p>	<p>Determines the offset value by which the Audition Phrase will be shifted from their original velocities. Settings: -64 – +0 – +63</p>
<p>③ Arp Select (Arpeggio Select) Determines whether the item being edited will commonly affect all five Arpeggios assigned to each Voice ("Arp Edit"), or affect only the selected Arpeggio ("Arp 1 – 5 Type").</p>	
<p>Arp Sw (Arpeggio Switch)</p>	<p>Determines whether Arpeggio playback is on or off. You can also turn this on or off from the front panel with the [AUDITION] button when the "Audition Button" (page 99) in the Utility General window is set to "arpeggio sw." Settings: off, on</p>
<p>Arp Select (Arpeggio Select)</p>	<p>Select the desired Arpeggio from Arpeggios 1 – 5. The 8th note icon shown in the settings indicates some Arpeggio Type (other than "off") is selected in the Arpeggio. Settings: Arp 1 – Arp 5</p>
<p>Arp Edit (Arpeggio Edit) Common settings for the five Arpeggios assigned to each Voice.</p>	
<p>Arp Sw (Arpeggio Switch)</p>	<p>Determines whether Arpeggio playback is on or off. This is the same function as the "Arp Sw" in the Arp Select display. Settings: off, on</p>
<p>Arp Hold (Arpeggio Hold)</p>	<p>When this is set to "on," the Arpeggio cycles automatically, even if Note Off message is received, and it continues to cycle until the next Note On message is received. Settings: sync-off, off, on sync-off..... When set to "sync-off," the Arpeggio playback continues to run silently, even when Note Off message is received. Receiving a Note On message turns the Arpeggio playback on again. NOTE When receiving the MIDI sustain message (control change #64) with "Arp Sw" set to "on," you can obtain the same result by setting "Arp Hold" to "on."</p>
<p>Arp Tempo (Arpeggio Tempo)</p>	<p>Determines the Arpeggio Tempo. This parameter can be changed directly via the Knob. Settings: 5 – 300 NOTE If you are using this instrument with an external sequencer, DAW software, or MIDI device, and you want to synchronize it with that device, set the "MIDI Sync" parameter in the Utility MIDI window (page 99) to "external" or "auto." When "MIDI Sync" is set to "auto" (only when MIDI clock is transmitted continuously) or "external," the Tempo parameter here indicates "external" and cannot be changed.</p>
<p>Velocity Rate</p>	<p>Determines how much the velocity of the Arpeggio playback is offset from the original value. A setting of 100% means the original velocities are used. Settings below 100% will reduce the velocities of the Arpeggio notes, whereas settings above 100% will increase them. If the resultant velocity value is less than zero it will be set to 1, and if the resultant velocity is greater than 128 it will be set to 127. Settings: 0 – 200%</p>
<p>Gate Time Rate</p>	<p>Determines how much the Gate Time (length) of the Arpeggio notes is offset from the original value. A setting of 100% means the original gate times are used. Settings below 100% will shorten the gate times of the Arpeggio notes, whereas settings above 100% will lengthen them. The Gate Time cannot be decreased beyond its normal minimum of 1; any values outside that range will automatically be limited to the minimum. Settings: 0 – 200%</p>

Unit Multiply	<p>Adjusts the Arpeggio playback time based on tempo. By using this parameter, you can create a different Arpeggio type from the original one. For example, if you set a value of 200%, the playback time will be doubled and the tempo halved. On the other hand, if you set a value of 50%, the playback time will be halved and the tempo doubled. Normal playback time is 100%.</p> <p>Settings: 50%, 66%, 75%, 100%, 133%, 150%, 200%</p>
Quantize Value	<p>Determines to what beats the note data in the Arpeggio will be aligned, or to what beats in the Arpeggio the swing is applied. The number shown at right of each value indicates the length assumes that the quarter-note resolution is 480.</p> <p>Settings: 60 (32nd note), 80 (16th note triplet), 120 (16th note), 160 (8th note triplet), 240 (8th note), 320 (1/4 note triplet), 480 (1/4 note)</p>
Quantize Strngth (Quantize Strength)	<p>Sets the "strength" by which note events are pulled toward the nearest quantize beats. A setting of 100% produces exact timing set via the "Quantize Value" parameter above. A setting of 0% results in no quantization. A setting of 50% result that the note events are pulled to the half point between the 0% and 100%.</p> <p>Settings: 0% – 100%</p>
Swing	<p>Delays notes on even-numbered beats (backbeats) to produce a swing feel. Settings above 1 delay the Arpeggio notes, whereas settings below -1 advance them. A setting of 0 produces exact timing set via the "Quantize Value." resulting in no swing. Judicious use of this setting lets you create swing rhythms and triplet feels, such as shuffle and bounce.</p> <p>Settings: -120 – +120</p> <p>NOTE When a triplet quantize value is used, the last note of each triplet will become the target for the swing.</p>
Octave Range	<p>Specifies the maximum Arpeggio range in octaves. Positive value settings increase the octave range of the Arpeggio playback upward, whereas negative value settings increase it downward.</p> <p>Settings: -3 – +0 – +3</p>
Change Timing	<p>Determines the actual timing at which the Arpeggio type is switched when you select another type during Arpeggio playback. When set to "realtime," the Arpeggio type is switched immediately. When set to "measure," the Arpeggio type is switched at the top of the next measure.</p> <p>Settings: realtime, measure</p>
Velocity Mode	<p>Adjusts the velocity of the Arpeggio notes when receiving the Note On message.</p> <p>Settings: original, thru</p> <p>original..... The Arpeggio plays back at the preset velocities included in the Arpeggio sequence data.</p> <p>thru The Arpeggio plays back according to the velocity of the received Note On message.</p>
Key Mode	<p>Determines how the Arpeggio plays back when receiving Note On messages.</p> <p>Settings: sort, thru, direct, sort+direct, thru+direct</p> <p>sort When the MOTIF-RACK XS receives specific Note On messages (for example, the notes of a chord), the same sequence plays, no matter what order it the Note On messages are received.</p> <p>thru When the MOTIF-RACK XS receives Note On messages (for example, the notes of a chord), the resulting sequence differs depending on the order of the Note On messages received.</p> <p>direct Note events of the Arpeggio sequence do not play; only the received Note On messages are heard. When the Arpeggio plays back, events such as Pan and Brightness are applied to the sound of your tone generator performance. Use this setting when the Arpeggio types includes non-note data or when the Category type "Ctrl" is selected.</p> <p>sort+direct The Arpeggio is played back according to the "sort" setting here, and the received Note On messages are also sounded.</p> <p>thru+direct The Arpeggio is played back according to the "thru" setting here, and the received Note On messages are also sounded.</p> <p>NOTE Some Arpeggio types belonging to the "Cntr" Category may not have note events (page 56). When such an Arpeggio type is selected and the Key Mode is set to "sort" or "thru," no sound is produced even if the MOTIF-RACK XS receives Note On messages.</p>
Note Limit Lo/Hi	<p>Determines the lowest and highest notes in the Arpeggio's note range. Notes received in this range trigger the Arpeggio. If you specify the highest note first and the lowest note second, for example "C5 to C4," then the note range covered will be "C -2 to C4" and "C5 to G8."</p> <p>Settings: C -2 – G8</p>
Velocity Limit Lo/Hi	<p>Determines the lowest and highest velocity which can trigger the Arpeggio playback. Arpeggio will only playback for notes received within its specified velocity range. If you specify the maximum value first and the minimum value second, for example "93 to 34," there will be a velocity "hole" and the velocity range covered will be "1 to 34" and "93 to 127."</p> <p>Settings: 1 – 127</p>
Octave Shift	<p>Shifts the pitch of the Arpeggio up or down in octaves.</p> <p>Settings: -10 – +10</p>
Loop	<p>When this is set to "on," the Arpeggio cycles while notes are held. When this is set to "off," the Arpeggio plays only once even if notes are held.</p> <p>Settings: off, on</p>

The Controls & Connectors

Setting Up

Listening to the Sound

Connections

Using a Computer

Quick Guide

Basic Structure

Voice

Multi

Utility

Appendix

<p>Trigger Mode</p>	<p>When this is set to “gate,” receiving a Note On message starts Arpeggio playback and receiving a Note Off message stops it. When this is set to “toggle,” receiving a Note On message starts/stops Arpeggio playback and receiving a Note Off message does not affect Arpeggio playback. Normally, this parameter should be set to “gate.”</p> <p>Settings: gate, toggle</p> <p>NOTE The Trigger Mode “toggle” setting overrides the Hold “on” setting in the Arp Edit display (page 66). In other words, even when the Hold parameter is set to “on,” receiving a Note On message start/stops Arpeggio playback when the Trigger Mode is set to “toggle.”</p>
<p>Accnt Vel Th (Accent Velocity Threshold)</p>	<p>Some preset Arpeggio types include special sequence data called “Accent Phrase,” which will be played back only when the velocities higher than a specified value are received. This parameter determines the minimum velocity that will trigger the Accent Phrase.</p> <p>Settings: off, 1 – 127</p>
<p>Accnt Strt Qtz (Accent Start Quantize)</p>	<p>Determines the start timing of the Accent Phrase when the Velocity specified in “Accent Vel Th” above is received. When set to off, the Accent Phrase starts as soon as the Velocity is received. When set to on, the Accent Phrase starts on the beat specified for each Arpeggio type after the Velocity is received.</p> <p>Settings: off, on</p>
<p>Random SFX</p>	<p>Some Arpeggio types feature a Random SFX function which will trigger special sounds (such as guitar fret noises) when the Note Off message is received. This parameter determines whether the Random SFX is active or not.</p> <p>Settings: off, on</p>
<p>SFX Vel Offset (Random SFX Velocity Offset)</p>	<p>Determines the offset value by which the Random SFX notes will be shifted from their original velocities. If the resultant velocity value is less than zero it will be set to 1, and if the resultant velocity is greater than 128 it will be set to 127.</p> <p>Settings: -64 – +0 – +63</p>
<p>SFX Key on Ctrl (Random SFX Key on Control)</p>	<p>When this is set to “off,” the Random SFX special sound is played with the pre-programmed velocity. When this is set to “on,” the Random SFX special sound is played with the velocity generated when the Note On message is received.</p> <p>Settings: off, on</p>

Arp 1 – 5 Type (Arpeggio 1 – 5 Type)

Specific settings for a selected Arpeggio in the Arp Select display.

<p>Main Ctgry (Main Category) Sub Ctgry (Sub Category)</p>	<p>Determines the Arpeggio Main Category and Sub Category including the desired Arpeggio type.</p> <p>Settings: See “Category List” in the Basic Structure (page 53).</p>
<p>Type</p>	<p>Determines the desired Arpeggio Type number from the specified Category. The number and name of the selected Arpeggio Type is shown at the second line from the top of the display. Refer to the Arpeggio Type List in “Arpeggio Type List” (separate online documentation), described on page 8.</p> <p>NOTE For details about how to use the “Arpeggio Type List,” see page 53.</p>
<p>Vel Rate (Velocity Rate Offset)</p>	<p>Determines the offset value by which the Arpeggio notes will be shifted from their original velocities. If the resultant velocity value is less than zero it will be set to 1, and if the resultant velocity is greater than 128 it will be set to 127.</p> <p>Settings: -100% – +0% – +100%</p>
<p>GTime Rate (Gate Time Rate Offset)</p>	<p>Determines the Gate Time (length) of the Arpeggio notes. The Gate Time cannot be decreased beyond its normal minimum of 1; any values outside that range will automatically be limited to the minimum.</p> <p>Settings: -100% – +0% – +100%</p>

4 Filter

Filter parameter settings common to all elements of the Voice.

<p>Cutoff</p>	<p>Determines the common offset value of filter Cutoff Frequencies for all Elements (page 76). This parameter can be changed directly via the Knob.</p> <p>Settings: -64 – +0 – +63</p>
<p>Resonance</p>	<p>Determines the common offset value of filter Resonance/Width for all Element (page 76). This parameter can be changed directly via the Knob.</p> <p>Settings: -64 – +0 – +63</p>

5 EG

Using the AEG and FEG, you can control the sound transition from the moment the sound starts to the moment the sound stops. The EG settings commonly affect all Elements.

<p>FEG Attack FEG Decay FEG Release FEG Depth</p>	<p>Determines the FEG (Filter Envelope Generator) parameters for each Part. Using the FEG, you can control the transition in tonal color (Cutoff Frequency) from the moment the sound starts to the moment the sound stops. The settings made here will be applied to the same parameters in the FEG (page 77) of Element Edit as offset. “FEG Sustain” is not available here. “FEG Depth” can be changed directly via the Knob.</p> <p>Settings: -64 – +0 – +63</p>
-------------------------------------------------------------------------------------------	-----------------------------------------------------------------------------------------------------------------------------------------------------------------------------------------------------------------------------------------------------------------------------------------------------------------------------------------------------------------------------------------------------------------------------------------------------------------------------

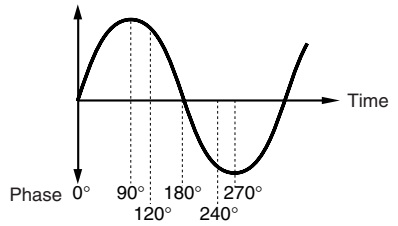
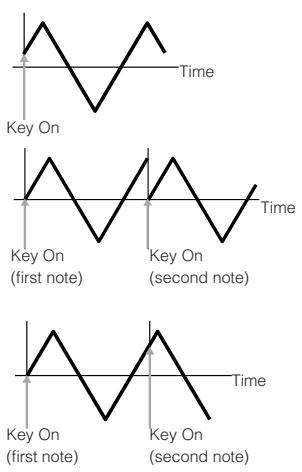
<p>AEG Attack AEG Decay AEG Sustain AEG Release</p>	<p>These can be used to control the change in volume from the moment a note is played to the moment the sound stops. The settings made here will be applied to the same parameters in the AEG (page 80) of Element Edit as offset. Each parameter can be changed directly via the Knob. Settings: -64 – +0 – +63</p>
<p>6 LFO (Common LFO) Determines how the vibrato, tremolo and wah effect are produced by using the LFO (Low Frequency Oscillator). The Common LFO parameter settings commonly affect all elements of the Voice.</p>	
<p>Wave</p>	<p>Selects the Wave and determines how the LFO waveform vibrates. Settings: triangle, triangle+, saw up, saw down, squ1/4, squ1/3, square, squ2/3, squ3/4, trapezoid, S/H1, S/H2, user You can use your original LFO wave by selecting this as the LFO wave. The LFO wave can be created only on the MOTIF-RACK XS Editor. For details about setting, see USER LFO parameters (page 71).</p>
<p>Play Mode</p>	<p>Determines whether the LFO cycles repeatedly (loop) or only once (one shot). Settings: loop, one shot</p>
<p>Speed</p>	<p>Determines the speed of the LFO Wave. The higher the value, the faster the speed. This parameter cannot be set when “Tempo Sync” is set to “on.” Settings: 0 – 63</p>
<p>Phase</p>	<p>Determines the starting phase point for the LFO Wave when it is reset. Settings: 0°, 90°, 120°, 180°, 240°, 270°</p> 
<p>Tempo Sync</p>	<p>Determines whether or not the LFO speed is synchronized to the tempo of the Arpeggio. Settings: off (not synchronized), on (synchronized) NOTE When this parameter is set to “on” and “MIDI Sync” in the MIDI display of the Utility (page 99) is set to “external” or “auto,” the LFO speed is synchronized with the external clock.</p>
<p>Tempo Speed</p>	<p>This parameter is available only when Tempo Sync above has been set to “on.” It allows you to make detailed note value settings that determine how the LFO pulses in sync with the Arpeggio. Settings: 16th, 8th/3 (eighth-note triplets), 16th. (dotted sixteenth note), 8th (eighth note), 4th/3 (quarter-note triplets), 8th (dotted 8th note), 4th (quarter notes), 2nd/3 (half-note triplets), 4th. (dotted quarter notes), 2nd (half notes), whole/3 (whole-note triplets), 2nd. (dotted half note), 4thx4 (quarter-note quadruplets; four quarter notes to the beat), 4thx5 (quarter-note quintuplets; five quarter notes to the beat), 4thx6 (quarter-note sextuplets; six quarter notes to the beat), 4thx7 (quarter-note septuplets; seven quarter notes to the beat), 4thx8 (quarter-note octuplets; eight quarter notes to the beat), 4thx16 (sixteen quarter notes to the beat), 4thx32 (32 quarter notes to the beat), 4thx64 (64 quarter notes to the beat) NOTE The note type setting above is synchronized with the tempo of the Arpeggio playback.</p>
<p>Key on Reset</p>	<p>Determines whether or not the LFO is reset each time a Note On message is received. The following three settings are available. Settings: off, each-on, 1st-on</p> <p>off The LFO cycles freely with no key synchronization. Receiving a Note On message starts the LFO wave at whatever phase the LFO happens to be at that point.</p> <p>each-on The LFO resets with each received Note On message and starts a waveform at the phase specified by the Phase parameter (above).</p> <p>1st-on The LFO resets with each received Note On message and starts a waveform at the phase specified by the Phase parameter (above). If a second Note On message is received while the first is being held, the LFO continues cycling according to the same phase as triggered by the first note. In other words, the LFO only resets if the first Note Off message is received before the second Note On message is received.</p>  <p>NOTE The starting phase is determined by the “Phase” parameter although the starting phase is shown as 0 in the illustration.</p>
<p>Random Speed</p>	<p>Determines the degree to which the LFO speed changes randomly. A setting of “0” results in the original speed. Higher values result in a larger degree of random speed change. This parameter cannot be set when “Tempo Sync” is set to on. Settings: 0 – 127</p>

The Controls & Connectors

Setting Up

Listening to the Sound

Connections

Using a Computer

Quick Guide

Basic Structure

Voice

Reference

Multi

Utility

Appendix

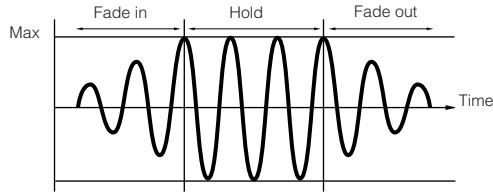
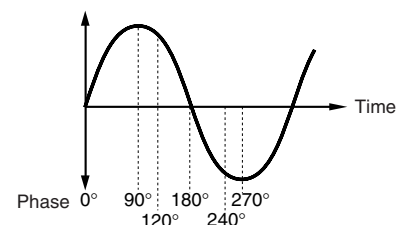
<p>Delay Time</p>	<p>Determines the delay time between the moment a Note On message is received and the moment the LFO takes effect. A higher value results in a longer delay time. Settings: 0 – 127</p>
<p>Fade in Time</p>	<p>Determines the amount of time for the LFO effect to fade in after the Delay time has elapsed. A higher value results in a slower fade-in. When set to "0," the LFO effect will not fade in and reach the maximum level immediately after the Delay time has elapsed. Settings: 0 – 127</p>
<p>Hold Time</p>	<p>Determines the length of time for which the LFO is held at its maximum level. A higher value results in a longer Hold time. A setting of hold produces no fade out. Settings: 0 – 126, hold</p> 
<p>Fade out Time</p>	<p>Determines the amount of time for the LFO effect to fade out (after the Hold time has elapsed). A higher value results in a slower fade-out. Settings: 0 – 127</p>
<p>LFO Set 1 – 3 Dest (LFO Set 1 – 3 Destination)</p>	<p>Determines the parameters which are to be controlled (modulated) by the LFO Wave. Three Destinations can be assigned, and you can choose from several parameters per Destination. Settings: insA1 – insA16, insB1 – insB16, A mod, P mod, F mod, reso, pan, LFOspd insA1 – insA16, insB1 – insB16, (Effect parameters) Each parameter of the selected Effect type is modulated cyclically. When one of those parameters is selected, the corresponding parameter name of the selected Effect type is shown in the display. A mod (Amplitude Modulation Depth) A tremolo effect produced by cyclically modulating the volume. P mod (Pitch Modulation Depth) A vibrato effect produced by cyclically modulating the pitch. F mod (Filter Modulation Depth) A wah effect produced by cyclically modulating the tonal brightness. reso (Resonance) A special wah effect produced by cyclically modulating the resonance. pan An effect produced by cyclically modulating the stereo pan position. LFOspd (Element LFO Speed) When this is selected, the Common LFO speed cyclically modulates the Element LFO speed. NOTE If one or more "LFO Set 1 – 3 Element Sw" is set to "off" in the one set on the MOTIF-RACK XS Editor and this parameter is set to something other than one of the effect parameters, "!" indications are shown at right of the "LFO Set 1 – 3 Dest" and "LFO Set 1 – 3 Depth" settings. This "!" mark indicates that the settings do not apply to all Elements.</p>
<p>LFO Set 1 – 3 Depth</p>	<p>Determines the LFO Wave Depth for each set. Settings: 0 – 127</p>
<p>LFO Set 1 – 3 Element Sw EDITOR</p>	<p>Determines whether or not each Element is to be affected by the LFO on the MOTIF-RACK XS Editor. When some buttons are set to "on", the appropriate Elements are to be affected by the LFO.</p>
<p>LFO Set 1 – 3 Depth Offset EDITOR</p>	<p>Determines the offset values of the "LFO Set 1 – 3 Depth" parameter (above) for the respective Elements on the MOTIF-RACK XS Editor. If the resultant "LFO Set 1 – 3 Depth" value is less than zero it will be set to 0, and if the resultant "LFO Set 1 – 3 Depth" value is greater than 127 it will be set to 127. Settings: 0 – 127</p>
<p>LFO Phase Offset EDITOR</p>	<p>Determines the offset values of the "Phase" parameter in the Wave for the respective Elements on the MOTIF-RACK XS Editor. Settings: 0°, 90°, 120°, 180°, 240°, 270°</p> 
<p>User LFO Cycle EDITOR</p>	<p>Determines the amount of steps for creating the wave on the MOTIF-RACK XS Editor. Settings: 2, 3, 4, 6, 8, 12, 16</p>
<p>User LFO Slope EDITOR</p>	<p>Determines the slope or ramp characteristics of the LFO wave on the MOTIF-RACK XS Editor. Settings: off, up, down, up&down off Creates no slope. up Creates an upward slope. down Creates a downward slope. up&down Creates an upward then downward slope.</p>

<p>User LFO Template EDITOR</p>	<p>You can select a pre-programmed template for the LFO wave on the MOTIF-RACK XS Editor. Settings: all -64, all 0, all +63, saw up, saw down, even step, odd step all 0 Values of all the steps are set to 0. all -64 Values of all the steps are set to -64. all +63 Values of all the steps are set to +63. saw up Creates a saw shaped upward wave. saw down Creates a saw shaped downward wave. even step Values of all odd steps are set to +63, and values of all even steps are set to -64. odd step Values of all even steps are set to +63, and values of all odd steps are set to -64. random Creates a base wave at random. Each time you click the random button, a different LFO wave appears on the display randomly.</p>
<p>User LFO Step Value 1 – 16 EDITOR</p>	<p>Determines the value for each step on the MOTIF-RACK XS Editor. Settings: -64 – +0 – +63</p>
<p>7 3 Band EQ</p>	
<p>Low Freq Low Gain Mid Freq Mid Gain Mid Q High Freq High Gain</p>	<p>This is a parametric EQ featuring three bands (High, Mid and Low). You can attenuate or boost the level of each frequency band (High, Mid, Low) to change the Voice sound. For the Mid band, you can also set the Q (Bandwidth). Each parameter except for “Low Freq” and “High Freq” can be changed directly via the Knob.</p> <p>Frequency Determines the frequency for each frequency band. Set the value to the frequency around which you wish to attenuate or boost. Settings: Low: 50.1Hz – 2.00kHz Mid: 139.7Hz – 10.1kHz High: 503.8Hz – 14.0kHz</p> <p>Gain Determines the level gain for the Frequency (set above), or the amount the selected frequency band is attenuated or boosted. The higher the value, the greater the Gain. The lower the value, the lesser the Gain. Settings: -12.00 dB – +0.00 dB – +12.00 dB</p> <p>Q (Bandwidth) Determines the Q (bandwidth) for the Mid band. The higher the value, the smaller the bandwidth. The lower the value, the wider the bandwidth. Settings: 0.7 – 10.3</p> <p>NOTE The Q setting is available only for the Mid band, which is a Peaking type EQ. Peaking (referring to the “peak” shape) lets you attenuate/boost a specific frequency and allows you to control how wide or narrow the bandwidth is. On the other hand, the EQ shape of the High and Low band is the Shelving type which lets you attenuate/boost the signal at frequencies above or below the specified Frequency setting.</p>
<p>8 Control</p>	
<p>Assign 1 Value Assign 2 Value</p>	<p>Determines the offset value by which the functions assigned to the Assign 1/2 will be shifted from their original settings. Each parameter can be changed directly via the Knob. Settings: -64 – +0 – +63</p> <p>NOTE The functions assigned to the Assign 1/2 Knobs can be set in “Ctrl Set 1 – 6 Dest” of “Ctrl Set 1 – 6 Src” (below) to which “Assign 1” or “Assign 2” are assigned.</p>
<p>Ctrl Set 1 – 6 Src (Controller Set 1 – 6 Source)</p>	<p>Determines which panel controller is to be assigned and used for the selected Set. You can also assign multiple functions to a controller. Settings: PitchBend, ModWheel, AfterTch (Aftertouch), FootCtrl1 (Foot Controller1), FootSw (Footswitch), Ribbon, Breath, Assign1, Assign2, FootCtrl2 (Foot Controller2), A. Func 1 (Assignable Function 1), A. Func 2 (Assignable Function 2)</p> <p>NOTE The Control Change number for the assignable controllers are set in the Utility Controller window (page 101). NOTE You can determine the degree to which the Pitch Bend wheel affects the Destination parameter (below) by setting the “PB Range Upper (Pitch Bend Range Upper)” and “PB Range Lower (Pitch Bend Range Lower)” in the Play Mode display (page 65).</p>
<p>Ctrl Set 1 – 6 Dest (Controller Set 1 – 6 Destination)</p>	<p>Determines the parameter that is controlled by the Source controller (above). You can select a parameter for each controller from the 69 parameters, such as volume, pitch and LFO depth. Settings: Refer to the Control List in the separate Data List booklet.</p> <p>NOTE Regarding “Insertion Effect A Parameter 1 – 16” and “Insertion Effect B Parameter 1 – 16” described in the Control List, the actual parameter names of the selected Effect type are shown on the display. If “insA/B---(Prm 1 - 16)” is shown, no function is assigned to that parameter.</p> <p>NOTE If one or more “Controller Set 1 – 6 Element Sw” is set to “off” in the one set on the MOTIF-RACK XS Editor and this parameter is set to a function related to Elements, “!” indications are shown at right of the “Ctrl Set 1 – 6 Src,” “Ctrl Set 1 – 6 Dest” and “Ctrl Set 1 – 6 Depth” settings. This “!” mark indicates that the settings do not apply to all Elements.</p>
<p>Ctrl Set 1 – 6 Depth (Controller Set 1 – 6 Depth)</p>	<p>Determines the degree to which the Source controller affects the Destination parameter. For negative values, the controller operation is reversed; maximum controller settings produce minimum parameter changes. Settings: -64 – +0 – +63</p>
<p>Controller Set 1 – 6 Element Sw EDITOR</p>	<p>Determines whether or not the selected controller affects each individual element on the MOTIF-RACK XS Editor. This parameter is disabled when the “Ctrl Set 1 – 6 Dest” described above is set to a parameter unrelated to the Voice Elements. When some buttons are set to “on,” the corresponding Elements are to be affected by the selected controller.</p>

The Controls & Connectors

Setting Up

Listening to the Sound

Connections

Using a Computer

Quick Guide

Basic Structure

Voice

Reference

Multi

Utility

Appendix

9 Effect

NOTE This display can be called up by pressing and holding the [EFFECT] button on the front panel.

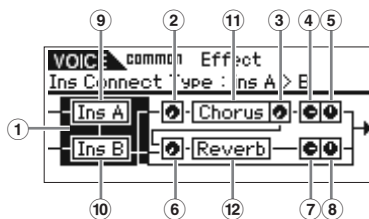

<p>① Insertion Connection</p>	<p>From this display you can set the effect routing for Insertion Effects A and B. The setting changes are shown on the diagram in the display, giving you a clear picture of how the signal is routed. For details, see page 58.</p> <p>Settings: parallel, ins A > B, ins B > A</p> <p>parallel..... Signals processed with the Insertion Effect A and B block will be sent to the Reverb, Chorus, Master Effect and Master EQ blocks.</p> <p>ins A > B..... Signals processed with Insertion Effect A will be sent to Insertion Effect B and signals processed with Insertion Effect B are sent to the Reverb, Chorus, Master Effect and Master EQ blocks.</p> <p>ins B > A..... Signals processed with Insertion Effect B will be sent to Insertion Effect A and signals processed with Insertion Effect A are sent to the Reverb, Chorus, Master Effect and Master EQ blocks.</p>
<p>② Chorus Send</p>	<p>Adjusts the chorus send level. The higher the value, the more pronounced the Chorus. This parameter can be changed directly via the Knob.</p> <p>Settings: 0 – 127</p>
<p>③ Chorus To Reverb</p>	<p>Determines the Send level of the signal sent from the Chorus Effect to the Reverb Effect. The higher the value, the deeper the Reverb that is applied to the Chorus-processed signal.</p> <p>Settings: 0 – 127</p>
<p>④ Chorus Return</p>	<p>Determines the Return level of the Chorus Effect.</p> <p>Settings: 0 – 127</p>
<p>⑤ Chorus Pan</p>	<p>Determines the pan position of the Chorus effect sound.</p> <p>Settings: L63 (far left) – C (center) – R63 (far right)</p>
<p>⑥ Reverb Send</p>	<p>Adjusts the reverb send level. The higher the value, the more pronounced the Reverb. This parameter can be changed directly via the Knob.</p> <p>Settings: 0 – 127</p>
<p>⑦ Reverb Return</p>	<p>Determines the Return level of the Reverb Effect.</p> <p>Settings: 0 – 127</p>
<p>⑧ Reverb Pan</p>	<p>Determines the pan position of the Reverb effect sound.</p> <p>Settings: L63 (far left) – C (center) – R63 (far right)</p>
<p>Element Out 1 – 8 EDITOR</p>	<p>Determines which Insertion Effect (A or B) is used to process each individual Element on the MOTIF-RACK XS Editor. The "thru" setting lets you bypass the Insertion Effects for the specified element.</p> <p>Settings: thru (through), insA (insertion A), insB (insertion B)</p>
<p>⑨ Ins A (Insertion Effect A) ⑩ Ins B (Insertion Effect B) ⑪ Chorus ⑫ Reverb</p>	<p>When the cursor is located here, pressing the [ENTER] button or the Encoder knob calls up the Effect Parameter display.</p>

Effect Parameters

<p>Switch</p>	<p>This parameter is available only for Master Effect. The value cannot be changed here.</p>
<p>Category Type</p>	<p>From the Category column, you can select one of the Effect Categories, each of which contains similar Effect types. From the Type column, you can select one of the Effect Types listed in the selected Category.</p> <p>Settings: Details about the Effect categories and the Effect types are described on page 59.</p> <p>NOTE The "Category" is not edited in the Reverb effect parameter display because there is only one Reverb category.</p>
<p>Preset</p>	<p>This lets you call up pre-programmed settings for each Effect Type, designed to be used for specific applications and situations.</p> <p>NOTE For details about "Preset" settings, refer to the separate Data List booklet.</p>
<p>Effect Parameter 1 – 16</p>	<p>The effect parameter differs depending on the currently selected effect type. Refer to page 61 for details about the Effect parameters. Refer to the separate Data List booklet for information on the parameters for each Effect type.</p>

Element Edit EDITOR

If you wish to edit the sounds that make up a Voice and the detailed parameters that determine the sound, such as Oscillator, Pitch, Filter, Amplitude, and EG (Envelope Generator), use the MOTIF-RACK XS Editor to edit the parameters of the individual Elements. These parameters can be edited only on the MOTIF-RACK XS Editor, and not the device itself. For details on each parameter setting window, refer to the MOTIF-RACK XS Editor Owner's Manual.

OSC (Oscillator)	
Element Switch 1 – 8	Determines whether each Element is on or off. When this is set to off, the corresponding Elements will not sound. Settings: off (inactive), on (active)
Wave Bank Category Number Name	Determines the Waveform assigned to the Element. Preset Banks are available for the Waveform Bank. For details about Preset Waveforms, see the Waveform list in the separate Data List.
XA Control (Expanded Articulation Control)	Expanded Articulation (XA) is a special feature of the MOTIF-RACK XS that provides greater performance flexibility and realism. This parameter determines how the XA feature of the Element works. Try setting this parameter referring to the five types of XA Control described in the Basic Structure on page 51. You can obtain the desired sound and expressive control depending on your performance articulation by assigning the same Element Group to those Elements having the same type of XA Control. Settings: normal, legato, key off sound, wave cycle, wave random, all AF off, AF 1 on, AF 2 on normal When this is selected, the Element will sound normally each time a Note On message is received. legato When this is selected and the Mono mode is selected, an alternate Element (different from the one used when XA Control is set to "normal") will be played when you play an external keyboard in legato fashion (playing the next note of a single-note line or melody before releasing the previous note). key off sound When this is selected, the Element will sound each time a Note Off message is received. wave cycle When this is selected for multiple Elements, each Element sounds alternately according to its numerical order each time a Note On message is received. (In other words, receiving the first Note On message will sound Element 1, the second Note On message Element 2, and so on.) wave random When this is selected for multiple Elements, each Element will sound randomly each time a Note On message is received. all AF off When this is selected, the Element will sound when both of the A, Func [1] and [2] buttons (ASSIGNABLE FUNCTION buttons) are turned off. AF 1 on When this is selected, the Element will sound when the A, Func [1] button (ASSIGNABLE FUNCTION [1] button) is turned on. AF 2 on When this is selected, the Element will sound when the A, Func [2] button (ASSIGNABLE FUNCTION [2] button) is turned on.
Elm Group (Element Group)	Determines the XA Control group so that the Elements of the same group are called up in order or randomly. Assign the same group number to the Elements having the same type of XA Control. The setting here is not available when the XA Control parameters of all Elements are set to "normal." Settings: 1 – 8
Key on Delay	Determines the time (delay) between the moment that a Note On message is received and the point at which the sound is played. The higher the value, the longer the delay time. Settings: 0 – 127
Tempo Sync (Delay Tempo Sync)	Determines whether or not the Key On Delay parameter is synchronized to the tempo of the Arpeggio. Settings: off (not synchronized), on (synchronized)
Tempo (Delay Tempo)	Determines the timing of the Key On Delay only when Tempo Sync is set to "on." Settings: 16th, 8th/3 (eighth-note triplets), 16th. (dotted sixteenth notes), 8th, 4th/3 (quarter-note triplets), 8th. (dotted eighth notes), 4th (quarter notes), 2nd/3 (half-note triplets), 4th. (dotted quarter notes), 2nd (half notes), whole/3 (whole-note triplets), 2nd. (dotted half notes), 4th x 4 (quarter-note quadruplets; four quarter notes to the beat), 4th x 5 (quarter-note quintuplets; five quarter notes to the beat), 4th x 6 (quarter-note sextuplets; six quarter notes to the beat), 4th x 7 (quarter-note septuplets; seven quarter notes to the beat), 4th x 8 (quarter-note octuplets; eight quarter notes to the beat)
Vel Cross Fade (Velocity Cross Fade)	This determines how gradually the sound of an Element decreases in volume in proportion to the distance of velocity changes outside the Velocity Limit setting. A setting of 0 produces no sound outside the Velocity Limit. The higher the value, the more gradual the level decreases. The practical application of this parameter is to create natural-sounding velocity cross fades, in which different Elements (Waveforms) change gradually depending on how strongly or softly you play. Settings: 0 – 127

<p>Velocity Limit</p>	<p>Determines the minimum and maximum values of the velocity range within which each Element will respond. Each Element will only sound for Note On messages within the specified velocity range received. If you specify the maximum value first and the minimum value second, for example "93 to 34," then the velocity range covered will be "1 to 34" and "93 to 127." Settings: 1 – 127</p>
<p>Note Limit</p>	<p>Determines the lowest and highest notes of a keyboard range for each Element. The selected Element will sound only when Note On messages within this range are received. Settings: C -2 – G8</p>
<p>Tune</p>	
<p>Coarse (Coarse Tuning)</p>	<p>Determines the pitch of each Element in semitones. Settings: -48semi – +0semi – +48semi</p>
<p>Fine (Fine Tuning)</p>	<p>Determines the pitch of each Element in cents. Settings: -64 cent – +0 cent – +63 cent</p>
<p>Vel Sens (Pitch Velocity Sensitivity)</p>	<p>Determines how the pitch of the Element responds to velocity. Positive settings will cause the pitch to rise the more strongly you play an external keyboard and negative settings will cause it to fall. A setting of 0 results in no change in pitch. Negative settings will cause the pitch to rise the more softly you play. Settings: -64 – +0 – +63</p>
<p>Fine Scaling (Fine Scaling Sensitivity)</p>	<p>Determines the degree to which the notes (specifically, their position or octave range) affect the pitch in fine tuning (set above) of the selected Element, assuming C3 as the basic pitch. A positive setting will cause the pitch of lower notes to change lower and that of higher notes to change higher. Negative values will have the opposite effect. Settings: -64 – +0 – +63</p>
<p>Random</p>	<p>This lets you randomly vary the pitch of the Element for each time a Note On message is received. The higher the value, the greater the pitch variation. A value of "0" results in no pitch change. Settings: 0 – 127</p>
<p>Pitch Key Follow Center Key</p>	<p>Determines the central note number for Pitch Key Follow. The note number set here is the same pitch as normal regardless of the Pitch Key Follow setting. Settings: C -2 – G8</p>
<p>Pitch Key Follow (Pitch Key Follow Sensitivity)</p>	<p>Determines the sensitivity of the Key Follow effect (the pitch interval of adjacent notes), assuming the pitch of the "Pitch Key Follow Center Key" as standard. At +100% (the normal setting), adjacent notes are pitched one semitone (100 cents) apart. At 0%, all notes are the same pitch specified as the Center Key. For negative values, the settings are reversed. Settings: -200% – +0% – +200%</p> <p>NOTE This parameter is useful for creating alternate tunings, or for use with sounds that do not need to be spaced in semitones, such as pitched drum sounds in a Normal Voice.</p>
<p>PEG (Pitch EG)</p>	
<p>Time</p>	<p>Determines the Time settings for Pitch EG. The Time parameters let you set the time between the adjoining points of the Level parameters below. A higher value results in a longer time until reaching the next level. Settings: 0 – 127</p> <p>Hold Time Determines the time between the moment a Note On message is received and the moment the envelope starts to rise.</p> <p>Attack Time Determines the speed of attack from the initial pitch (Hold Level) to the normal pitch (Attack Level) of the Voice after the hold time has elapsed.</p> <p>Decay 1 Time Determines how fast the envelope falls from the normal pitch (Attack Level) of the Voice to the pitch specified as the Decay 1 Level.</p> <p>Decay 2 Time Determines how fast the envelope falls from the pitch specified as the Decay 1 Level to the pitch specified as the Decay 2 Level.</p> <p>Release Time Determines how fast the envelope falls to the pitch specified as the Release Level when a Note Off message is received.</p>

Pitch Key Follow and Center Key

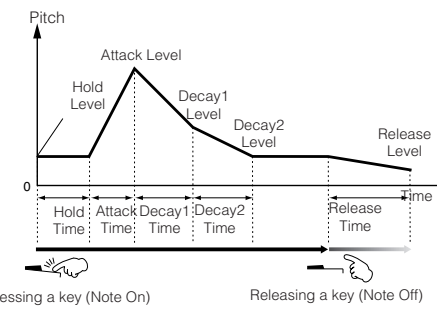
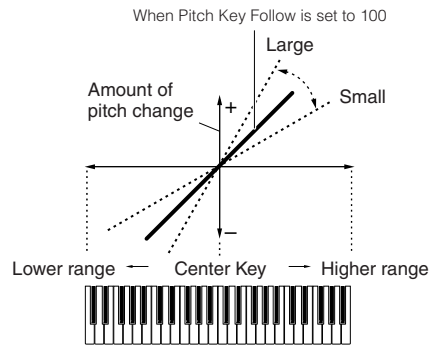

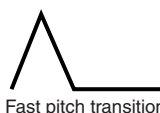
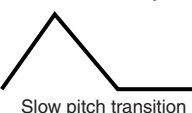
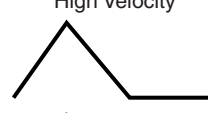
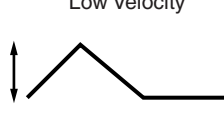
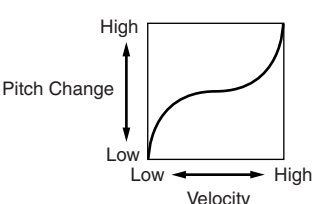
<p>Level</p>	<p>Determines the Level settings for the Pitch EG. The Level parameters let you set the amount of the pitch deviation based on the standard pitch specified at the Coarse (Coarse Tuning) and Fine (Fine Tuning) parameters in the Tune (page 74) section for each envelope point.</p> <p>Settings: -128 – +0 – +127</p> <p>Hold Level Determines the initial pitch at the moment a Note On message is received.</p> <p>Attack Level Determines the normal pitch reached when the envelope is changed from the Hold Level for the first time.</p> <p>Decay 1 Level Determines the pitch level to which the sound changes from the Attack Level after the Decay 1 Time elapses.</p> <p>Decay 2 Level Determines the sustain-level pitch which will be maintained while a note is held.</p> <p>Release Level Determines the final pitch reached after a Note Off message is received.</p>
<p>Time Velocity Sens (EG Time Velocity Sensitivity)</p>	<p>Determines how the PEG transition time (speed) responds to velocity, or the strength with which the note is pressed. When this is set to a positive value, high velocities result in a fast PEG transition speed while low velocities result in a slow speed, as shown below. When this is set to a negative value, high velocities result in a slow AEG transition speed while low velocities result in a fast speed. When this is set to 0, the amplitude transition speed does not change, no matter what the velocity.</p> <p>Settings: -64 – +0 – +63</p> <div style="display: flex; justify-content: space-around; align-items: center;"> <div style="text-align: center;"> <p>High Velocity</p>  <p>Fast pitch transition</p> </div> <div style="text-align: center;"> <p>Low Velocity</p>  <p>Slow pitch transition</p> </div> </div>
<p>Segment (EG Time Velocity Sensitivity Segment)</p>	<p>Determines the part of the Pitch EG affected by the EG Time Velocity Sens parameter.</p> <p>Settings: attack, atk+dcy, decay, atk+rls, all</p> <p>attack Time Vel Sens affects the Attack Time and Hold Time.</p> <p>atk+dcy (attack+decay) Time Vel Sens affects the Attack Time, Decay 1 Time, and Hold Time.</p> <p>decay Time Vel Sens affects the Decay 1/2 Time.</p> <p>atk+rls (attack+release) Time Vel Sens affects the Attack Time, Release Time, and Hold Time.</p> <p>all Time Vel Sens affects all the Pitch EG Time parameters.</p>
<p>EG Depth</p>	<p>Determines the range over which the pitch envelope changes. A setting of 0 will cause the pitch not to change. The farther from 0 the value is, the larger the pitch range. For negative values, the pitch change is reversed.</p> <p>Settings: -64 – +0 – +63</p>
<p>EG Depth Vel Sens (EG Depth Velocity Sensitivity)</p>	<p>Determines how the pitch range of the Element responds to velocity. When this is set to a positive value, high velocities cause the pitch range to expand and low velocities cause it to contract, as shown below. When this is set to a negative value, the opposite effect is produced: High velocities cause the pitch range to contract and low velocities cause it to expand. When this is set to 0, the pitch envelope does not change no matter what the velocity.</p> <p>Settings: -64 – +0 – +63</p> <div style="display: flex; justify-content: space-around; align-items: center;"> <div style="text-align: center;"> <p>High Velocity</p>  <p>Large range</p> </div> <div style="text-align: center;"> <p>Low Velocity</p>  <p>Small range</p> </div> </div>
<p>EG Depth Curve (EG Depth Velocity Sensitivity Curve)</p>	<p>The five curves determine how the pitch range will be generated according to the velocity (strength) with which you play notes on an external keyboard. The selected curve is indicated by the graphic at the right of this parameter on the window. The horizontal axis of the graph represents velocity, and the vertical axis represents pitch range.</p> <p>Settings: Curve 0 – 4</p> <div style="text-align: right;">  </div>

The Controls & Connectors
Setting Up
Listening to the Sound
Connections
Using a Computer
Quick Guide
Basic Structure
Voice
Reference
Multi
Utility
Appendix

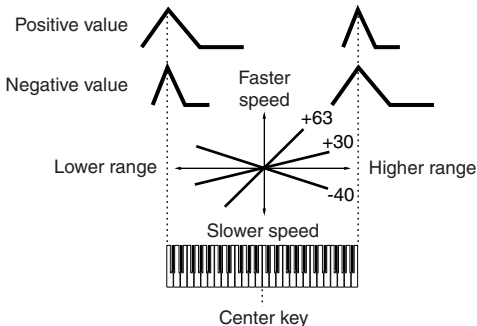
<p>Time Key Follow Center Key (EG Time Key Follow Sensitivity Center Key)</p>	<p>Determines the central note for EG Time Key Follow. When the Center Key note is played on a keyboard, the PEG behaves according to its actual settings. Settings: C -2 – G8</p>	 <p>The diagram illustrates the relationship between pitch EG transition speed and note position. It shows two waveforms: one for a 'Positive value' which rises to a peak and then falls, and one for a 'Negative value' which falls to a trough and then rises. Below these, a keyboard diagram shows a 'Center key' with arrows indicating 'Faster speed' towards higher notes and 'Slower speed' towards lower notes. Specific values are marked: +63, +30, and -40.</p>
<p>Time Key Follow (EG Time Key Follow Sensitivity)</p>	<p>Determines the degree to which the notes (specifically, their position or octave range) affect the pitch EG times of the selected Element. When this is set to a positive value, high notes result in a high pitch EG transition speed while low notes result in a slow speed. When this is set to a negative value, the opposite effect is produced: High notes result in a slow pitch EG transition speed while low notes result in a high speed. When this is set to 0, the pitch EG transition speed does not change no matter what note number is received as a Note On message. Settings: -64 – +0 – +63</p>	
<p>Filter Type</p>		
<p>Type</p>	<p>Determines the Filter Type for the current Element. For details about each type, refer to “Filter Type List” in the Supplementary information (page 88). Settings: LPF24D, LPF24A, LPF18, LPF18s, LPF12, LPF6, HPF24D, HPF12, BPF12D, BPFw, BPF6, BEF12, BEF6, Dual LPF, Dual HPF, Dual BPF, Dual BEF, LPF12+BPF6, thru</p>	
<p>Cutoff</p>	<p>The Cutoff Frequency is the center frequency at which unwanted frequencies of the audio are cut. This determines the Cutoff Frequency for the Filter to adjust the Filter effect. The tonal characteristics of the Voice and function of the Cutoff Frequency differ depending on which Filter type is selected. Set this parameter while confirming the Filter graph shown on the window. Settings: 0 – 255</p>	
<p>Cutoff Velocity Sens (Cutoff Velocity Sensitivity)</p>	<p>Determines how the Cutoff Frequency (specified in Cutoff above) responds to velocity, or the strength with which you play notes. Positive settings will cause the Cutoff Frequency to rise the more strongly you play an external keyboard. A setting of 0 will cause the Cutoff Frequency not to change no matter what velocity you play. Negative settings will cause the Cutoff Frequency to rise the more softly you play. Settings: -64 – +0 – +63</p>	
<p>Distance</p>	<p>Determines the distance between the two Cutoff frequencies, for the Dual Filter types (which feature two identical filters combined in parallel), and the LPF12 + BPF6 type. When any of other filter types is selected, this parameter is not available. Settings: -128 – +0 – +127</p>	
<p>Resonance/Width</p>	<p>This parameter’s function varies according to the selected Type. If the selected filter is an LPF, HPF, BPF (excluding the BPFw), or BEF, this parameter is used to set the Resonance. For the BPFw, it is used to adjust the frequency bandwidth. Resonance is used to set the amount of Resonance (harmonic emphasis) applied to the signal at the cutoff frequency. This can be used in combination with the cutoff frequency parameter to add further character to the sound. The Width parameter is used to adjust the width of the band of signal frequencies passed by the filter with the BPFw. When the Filter Type is set to “LPF6” or “thru,” this parameter is not available. Settings: 0 – 127</p>	
<p>Resonance Velocity Sens (Resonance Velocity Sensitivity)</p>	<p>Determines the degree to which resonance responds to velocity, or the strength with which you play notes. For positive values, the higher the velocity, the greater the resonance. A setting of 0 results in no change of the Resonance value. For negative values, the lower the velocity, the greater the resonance. Settings: -64 – +0 – +63</p>	
<p>Gain</p>	<p>Determines the Gain of the signal sent to the filter. The lower the value, the lower the Gain. The tonal characteristics generated by the filter differ depending on the value set here. Settings: 0 – 255</p>	
<p>Center Key (Cutoff Key Follow Center Key / HPF Key Follow Center Key)</p>	<p>This indicates that the central note for Cutoff Key Follow and HPF Key Follow above is C3. Keep in mind that this is for display purposes only; the value cannot be changed.</p>	

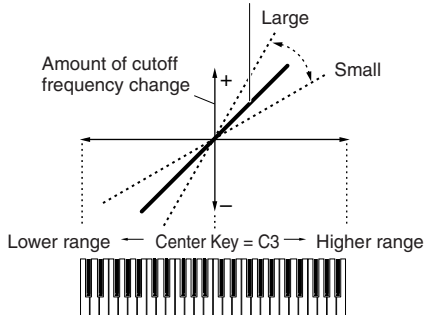
<p>Cutoff Key Follow (Cutoff Key Follow Sensitivity)</p>	<p>Determines the degree to which the notes (specifically, their position or octave range) affect the "Cutoff" (set above) of the selected Element, assuming C3 as the basic pitch. A positive setting will lower the Cutoff frequency for lower notes and raise it for higher notes. A negative setting will have the opposite effect.</p> <p>Settings: -200% – +0% – +200%</p>	<p>Cutoff Key Follow and Center Key When Center Key Follow is set to 100</p> 
<p>HPF Cutoff (High Pass Filter Cutoff Frequency)</p>	<p>Determines the central frequency for the Key Follow parameter (below) of the HPF. This parameter is available only when filter types LPF12 or LPF6 are selected.</p> <p>Settings: 0 – 255</p>	
<p>HPF Key Follow (High Pass Filter Cutoff Key Follow Sensitivity)</p>	<p>Determines the degree to which the notes (specifically, their position or octave range) affect the "Cutoff" (set above) of the HPF. A positive setting will lower the Cutoff frequency for lower notes and raise it for higher notes. A negative setting will have the opposite effect. A setting of 0 will result in no change in the note. This parameter is available only when filter types LPF12 or LPF6 are selected.</p> <p>Settings: -200% – +0% – +200%</p>	

FEG (Filter EG)

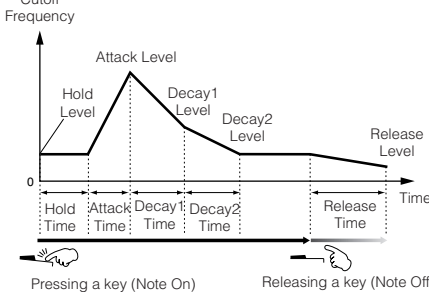
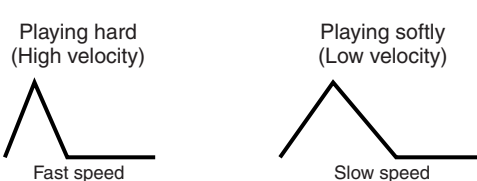
<p>Time</p>	<p>Determines the time settings for the Filter EG. The Time parameters let you set the time between the adjoining points of the level parameters below. When the current Level setting is the same as the next, the corresponding Time indicates the length of time for which the Level is held at the current setting. A higher value results in a longer time until reaching the next level.</p> <p>Settings: 0 – 127</p> <p>Hold Time Determines the time between the moment a Note On message is received and the moment the envelope starts to rise.</p> <p>Attack Time Determines the speed of attack from the initial cutoff frequency (Hold Level) to the maximum level (Attack Level) of the Voice after the hold time has elapsed.</p> <p>Decay 1 Time Determines how fast the envelope falls from the maximum cutoff frequency (Attack Level) to the cutoff frequency specified as the Decay 1 Level.</p> <p>Decay 2 Time Determines how fast the envelope falls from the cutoff frequency specified as the Decay 1 Level to the cutoff frequency specified as the Decay 2 Level.</p> <p>Release Time Determines how fast the envelope falls to the cutoff frequency specified as the Release Level when a Note Off message is received.</p>	
<p>Level</p>	<p>Determines the level settings for the Filter EG. The Level parameters let you set the amount of the filter change at each point based on the cutoff frequency specified in the Filter Type (page 76).</p> <p>Settings: -128 – +0 – +127</p> <p>Hold Level Determines the initial cutoff frequency at the moment a Note On message is received.</p> <p>Attack Level Determines the maximum cutoff frequency which the envelope reaches after a Note On message is received.</p> <p>Decay 1 Level Determines the cutoff frequency to which the sound changes from the Attack Level after the Decay 1 Time elapses.</p> <p>Decay 2 Level Determines the cutoff frequency which will be maintained while a note is held.</p> <p>Release Level Determines the final pitch reached after a Note Off message is received.</p>	
<p>Time Velocity Sens (EG Time Velocity Sensitivity)</p>	<p>Determines how the FEG transition time (speed) responds to velocity, or the strength with which the note is pressed. When this is set to a positive value, high velocities result in a fast FEG transition speed while low velocities result in a slow speed, as shown below. When this is set to a negative value, the opposite effect is produced: High velocities result in a slow FEG transition speed while low velocities result in a fast speed. When this is set to 0, the FEG transition speed does not change no matter what the velocity.</p> <p>Settings: -64 – +0 – +63</p>	

The Controls & Connectors

Setting Up

Listening to the Sound

Connections

Using a Computer

Quick Guide

Basic Structure

Voice

Multi

Utility

Appendix

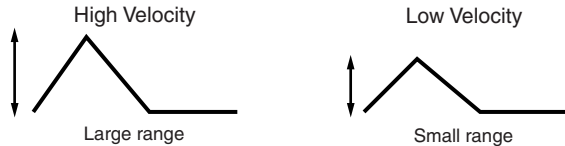
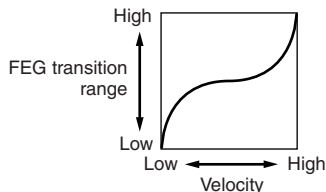
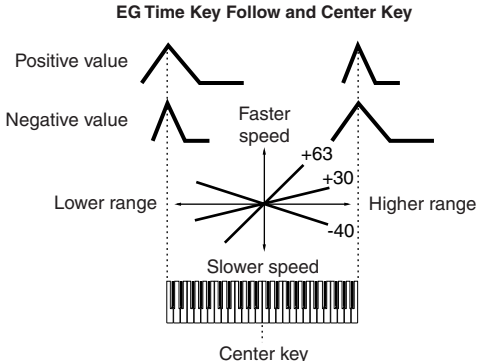
<p>Segment (EG Time Velocity Sensitivity Segment)</p>	<p>Determines the part of the Filter EG affected by the Time Velocity Sens parameter. Settings: attack, atk+dcy, decay, atk+r/s, all For details on the above settings, see "Segment" (page 75) in the "PEG."</p>
<p>EG Depth</p>	<p>Determines the range over which the cutoff frequency of the Filter EG changes. A setting of 0 will result in no change in the cutoff frequency. The farther from 0 the value is, the larger the range of the cutoff frequency. For negative values, the change of the cutoff frequency is reversed. Settings: -64 - +0 - +63</p>
<p>EG Depth Vel Sens (EG Depth Velocity Sensitivity)</p>	<p>Determines how the range of the cutoff frequency responds to velocity. When this is set to a positive value, high velocities cause the Filter EG range to expand and low velocities cause it to contract, as shown below. When this is set to a negative value, the opposite effect is produced: High velocities cause the Filter EG range to contract and low velocities cause it to expand. When this is set to 0, the Filter EG range does not change no matter what the velocity. Settings: -64 - +0 - +63</p> <div style="text-align: center;">  </div>
<p>EG Depth Curve (EG Depth Velocity Sensitivity Curve)</p>	<p>The five curves determine how the FEG transition range changes according to the velocity (strength) with which you play notes on an external keyboard. The selected curve is indicated by the graphic at the right of this parameter on the window. The horizontal axis of the graph represents velocity, and the vertical axis represents Cutoff Frequency range. Settings: Curve 0 - 4</p> <div style="text-align: center;">  </div>
<p>Time Key Follow Center Key (EG Time Key Follow Sensitivity Center Key)</p>	<p>Determines the central note for the Time Key Follow parameter. When the Center Key note is played on a keyboard, the FEG behaves according to its actual settings. Settings: C -2 - G8</p> <div style="text-align: center;">  </div>
<p>Time Key Follow (EG Time Key Follow Sensitivity)</p>	<p>Determines the degree to which the notes (specifically, their position or octave range) affect the Filter EG times of the selected Element. When this is set to a positive value, high notes result in a fast Filter EG transition speed while low notes result in a slow speed. When this is set to a negative value, the opposite effect is produced: High velocities result in a slow Filter EG transition speed while low notes result in a fast speed. When this is set to 0, the Filter EG transition speed does not change no matter what note number is received as a Note On message. Settings: -64 - +0 - +63</p>
<p>Filter Scale</p>	
<p>Break Point 1 - 4</p>	<p>Determines the four Break Points by specifying the respective note numbers. Settings: C -2 - G8 NOTE Break Point 1 to Break Point 4 will be automatically be arranged in ascending order across the keyboard.</p>
<p>Cutoff Offset 1 - 4</p>	<p>Determines the offset value to the Cutoff parameter at each Break Point. For details about Filter Scaling, refer to "Setting example of Filter Scaling" (page 90) of the Supplementary information. Settings: -128 - +0 - +127 NOTE Regardless of the size of these Offsets, the minimum and maximum Cutoff limits (values of 0 and 127, respectively) cannot be exceeded. NOTE Any note played below the Break Point 1 note results in the Break Point 1 Level setting. Likewise, any note played above the Break Point 4 note results in the Break Point 4 Level setting.</p>
<p>AMP Level/Pan</p>	
<p>Level</p>	<p>Determines the output level of the Element. Settings: 0 - 127</p>

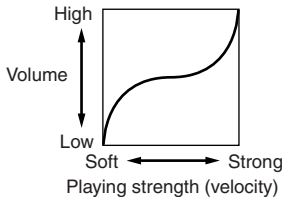
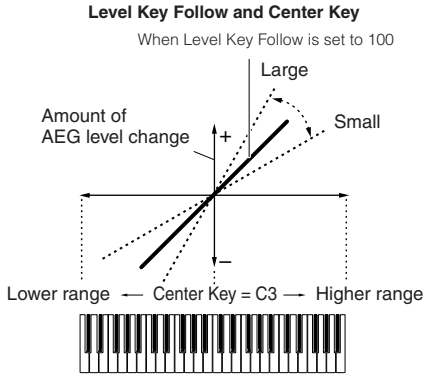
<p>Level Velocity Sens (Level Velocity Sensitivity)</p>	<p>Determines how the output level of the Element responds to velocity. Positive settings will cause the output level to rise the harder you play an external keyboard. A setting of 0 will cause the output level not to change. Negative settings will produce the opposite effect, causing the output level to rise the more softly you play. Settings: -64 – +0 – +63</p>
<p>Level Velocity Curve (Level Velocity Sensitivity Curve)</p>	<p>The five curves determine how the actual velocity will be generated according to the velocity (strength) with which you play notes on an external keyboard. The selected curve is indicated by the graphic at the right of this parameter on the window. The horizontal axis of the graph represents velocity, and the vertical axis represents volume range. Settings: Curve 0 – 4</p> 
<p>Level Velocity Offset (Level Velocity Sensitivity Offset)</p>	<p>Raises or lowers the level specified in Level Velocity Sens above. A setting of 64 results in the original Level Velocity Sens values being used. Settings above 64 will raise the level specified in Level Velocity Sensitivity. Settings: 0 – 127</p>
<p>Level Key Follow Center Key (Level Key Follow Sensitivity Center Key)</p>	<p>This indicates that the central note for Level Key Follow above is C3. Keep in mind that this is for display purposes only; the value cannot be changed.</p>
<p>Level Key Follow</p>	<p>Determines the degree to which the notes (specifically, their position or octave range) affect the amplitude level (set above) of the selected Element, assuming C3 as the basic pitch. A positive setting will lower the output level for lower notes and raise it for higher notes. A setting of 0 will cause the output level not to change. A negative setting will have the opposite effect. Settings: -200% – +0% – +200%</p> 
<p>Pan</p>	<p>Adjusts the stereo pan position of the sound. Settings: L63 (far left) – C (center) – R63 (far right)</p>
<p>Alternate Pan</p>	<p>Determines the amount by which the sound is panned alternately left and right for each received Note On message, assuming the pan position set above as center. Higher values increase the width of the Pan range. Settings: L63 – C – R63</p>
<p>Random Pan</p>	<p>Determines the amount by which the sound of the selected Element is panned randomly left and right for each received Note On message. The Pan setting (above) is used as the Center Pan position. Settings: 0 – 127</p>
<p>Scaling Pan</p>	<p>Determines the degree to which the notes (specifically, their position or octave range) affect the Pan position (set above), left and right, of the selected Element. At note C3, the main Pan setting (above) is used for the basic Pan position. A positive setting will move the pan position leftward for lower notes and move it rightward for higher notes. A negative setting will have the opposite effect. Settings: -64 – +0 – +63</p>

The Controls & Connectors

Setting Up

Listening to the Sound

Connections

Using a Computer

Quick Guide

Basic Structure

Voice

Reference

Multi

Utility

Appendix

AEG (Amplitude EG)

Time

Determines the AEG transition time. The Time parameters let you set the time between the adjoining points of the Level parameters below. A higher value results in a longer time until reaching the next level.

Settings: 0 – 127

Attack Time
Determines how quickly the sound reaches its maximum level after a Note On message is received.

Decay 1 Time
Determines how fast the envelope falls from the Attack Level to the Decay 1 Level.

Decay 2 Time
Determines how fast the envelope falls from the Decay1 Level to the Decay 2 Level (sustain level).

Release Time
Determines how fast the volume falls from the sustain level to zero when a Note Off message is received.

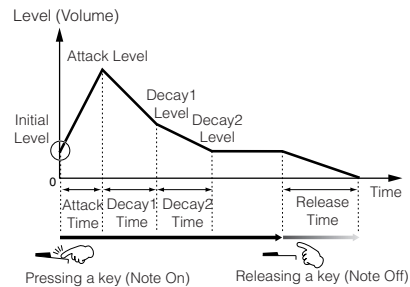

Level

Determines the Level settings for the Amplitude EG. The Level parameters let you set the amount of volume transition at each point based on the level specified in the AMP Level/Pan parameter (page 78).

Settings: 0 – 127

Initial Level Determines the initial level at the moment a Note On message is received.

Attack Level..... Determines the maximum level which the envelope reaches after a Note On message is received.

Decay 1 Level Determines the level which the envelope reaches from the Attack Level after the Decay 1 Time elapses.

Decay 2 Level Determines the level which will be maintained while a note is held from the Decay 1 Level.

Time Vel Sens (EG Time Velocity Sensitivity)

Determines how the AEG transition time (speed) responds to velocity, or the strength with which the note is pressed. When this is set to a positive value, high velocities result in a fast AEG transition speed while low velocities result in a slow speed, as shown below. When this is set to a negative value, the opposite effect is produced: High velocities result in a slow AEG transition speed while low velocities result in a fast speed. When this is set to 0, the amplitude transition speed does not change no matter what the velocity.

Settings: -64 – +0 – +63

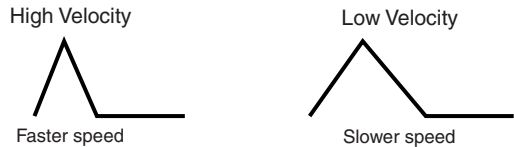

Segment (EG Time Velocity Sensitivity Segment)

Determines the part of the Amplitude EG affected by the Time Vel Sens parameter.

Settings: attack, atk+dcy, decay, atk+rls, all

attack..... Time Vel Sens affects the Attack Time.

atk+dcy (attack+decay).... Time Vel Sens affects the Attack Time and Decay 1 Time.

decay Time Vel Sens affects the Decay 1/2 Time.

atk+rls (attack+release) Time Vel Sens affects the Attack Time and Release Time.

all..... Time Vel Sens affects all the Amplitude EG Time parameters.

Half Damper (Half Damper Switch)

When the Half Damper Switch is set to on, you can produce a “half-pedal” effect just as on a real acoustic piano by using the external Controller assigned to control change number 64.

Settings: off, on

Half Damper Time

Determines how quickly the sound decays to silence after a Note Off message is received while maximizing the effect by using the external Controller assigned to control change number 64 with the Half Damper parameter turned on.

Settings: 0 – 127

Time Key Follow Center Key (EG Time Key Follow Sensitivity Center Key)

Determines the central note for the “Time Key Follow.” When the Center Key note is played, the AEG behaves according to its actual settings.

Settings: C -2 – G8

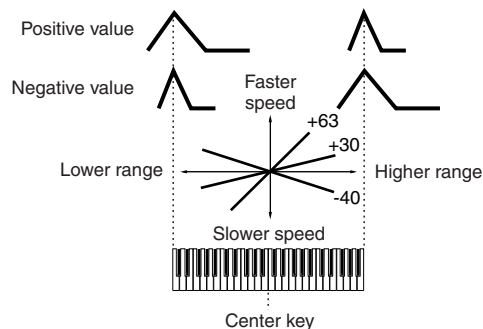

The Controls & Connectors | Setting Up | Listening to the Sound | Connections | Using a Computer | Quick Guide | Basic Structure | Voice | Multi | Utility | Appendix

Time Key Follow (EG Time Key Follow Sensitivity)	Determines the degree to which the notes (specifically, their position or octave range) affect the Amplitude EG times of the selected Element. When this is set to a positive value, high notes result in a fast Amplitude EG transition speed while low notes result in a slow speed. When this is set to a negative value, the opposite effect is produced: High velocities result in a slow Amplitude EG transition speed while low notes result in a fast speed. When this is set to 0, the Amplitude EG transition speed does not change no matter what the pressed note. Settings: -64 – +0 – +64
AMP Scale (Amplitude Scale)	
Break Point 1 – 4	Determines the four Break Points by specifying the respective note numbers. Settings: C -2 – G8 NOTE Break Point 1 to Break Point 4 will be automatically be arranged in ascending order across the keyboard.
Level Offset 1 – 4	Determines the offset value to the level at each Break Point. For details about Amplitude Scaling, refer to “Setting example of Amplitude Scaling” (page 90) in the Supplementary information. Settings: -128 – +0 – +127
LFO (Low Frequency Oscillator)	
LFO Wave	Selects the Wave and determines how the LFO waveform modulates the sound. Settings: saw, triangle, square
Speed	Determines the speed of the LFO Wave. Settings: 0 – 63
Key on Reset	When this is set to on, the LFO waveform is reset every time a Note On message is received. Settings: off, on off The LFO cycles freely with no key synchronization. Receiving a Note On message starts the LFO wave at whatever phase the LFO happens to be at that point. on The LFO resets with each received note and starts a waveform at the phase specified by the Phase parameter (page 69).
Delay	Determines the delay time between the moment a Note On message is received to the moment the LFO comes into effect. A higher value results in a longer delay time. Settings: 0 – 127
Fade in Time	Determines the amount of time for the LFO effect to fade in after the Delay time has elapsed. A higher value results in a slower fade-in. When set to “0,” the LFO effect will not fade in and reach the maximum level immediately after the Delay time has elapsed. Settings: 0 – 127
P Mod (Pitch Modulation)	Determines the amount (depth) by which the LFO wave varies (modulates) the pitch of the sound. The higher the setting, the greater the depth of control. Settings: 0 – 127
F Mod (Filter Modulation)	Determines the amount (depth) by which the LFO wave varies (modulates) the Filter Cutoff frequency. The higher the setting, the greater the depth of control. Settings: 0 – 127
A Mod (Amplitude Modulation)	Determines the amount (depth) by which the LFO wave varies (modulates) the amplitude or volume of the sound. The larger the setting, the greater the depth of control. Settings: 0 – 127
EQ	
Type (EQ Type)	Determines the EQ Type. The number of parameters and values available differs depending on the selected EQ type. Settings: 2 Band (2 Band EQ), P.EQ (Parametric EQ), Boost 6 (Boost +6dB), Boost 12 (Boost +12dB), Boost18 (Boost +18dB), thru 2 Band This is a “shelving” equalizer, which combines separate high and low frequency bands. P.EQ The Parametric EQ for the single band is used to attenuate or boost signal levels (gain) around the Low Freq according to the settings of Low Gain. Determines the bandwidth with which the sound will be boosted or cut in the “Q” parameter. Boost 6, Boost 12, Boost18 Boosts the entire band of the selected Element by +6dB, +12dB, and +18dB respectively. These settings have no adjustable parameters. thru If you select this, the equalizers are bypassed and the entire signal is unaffected.
Low Freq	This parameter is available only when the Type (EQ Type) parameter is set to “2 Band” or “P.EQ.” When setting to “2 Band,” this determines the center frequency of the lower EQ band. When setting to “P.EQ,” this determines the center frequency. Settings: When the Type is set to “2 Band”... 50.1Hz – 2.00kHz, When the Type is set to “P.EQ”... 139.7Hz – 12.9kHz
High Freq	This parameter is available only when the Type (EQ Type) parameter is set to “2 Band.” This determines the center frequency of the high EQ band. Settings: 503.8Hz – 10.1kHz

The Controls & Connectors
Setting Up
Listening to the Sound
Connections
Using a Computer
Quick Guide
Basic Structure
Voice
Reference
Multi
Utility
Appendix

The Controls & Connectors	<p>Low Gain</p> <p>This parameter is available only when the Type (EQ Type) parameter is set to “2 Band” or “P.EQ.” When setting to “2 Band,” this determines the amount by which signals below the “Low Freq” will be boosted/attenuated. When setting to “P.EQ,” this determines the amount by which signals in the area of the center frequency will be boosted/attenuated.</p> <p>Settings: -12.00dB – +0.00dB – +12.00dB</p>
Setting Up	<p>High Gain</p> <p>This parameter is available only when the Type (EQ Type) parameter is set to “2 Band.” This determines the amount by which signals above the “High Freq” will be boosted/attenuated.</p> <p>Settings: -12.00dB – +0.00dB – +12.00dB</p>
Listening to the Sound	<p>Q</p> <p>This parameter is available only when the Type (EQ Type) parameter is set to “P.EQ.” This determines the Q (bandwidth) for the band. The lower the setting, the greater the bandwidth. The higher the setting, the smaller the bandwidth.</p> <p>Settings: 0.7 – 10.3</p>

Listening to the Sound
Connections
Using a Computer
Quick Guide
Basic Structure
Voice
Multi
Utility
Appendix

Drum Voice Edit

Each Drum Voice can consist of up to 73 Drum Keys, assigned to notes (C0 to C6). There are two types of Drum Voice Edit: those for Common Edit to edit the settings common to all keys, and those for Key Edit to edit individual keys. In this section, we'll cover the Drum Voice parameters.

Common Edit

These parameters are for making global (or common) edits to all keys of the selected Drum Voice.

Procedure [VOICE] → select desired Drum Voice → [EDIT] → select desired display in the Voice Edit Select display → [ENTER] → Edit display

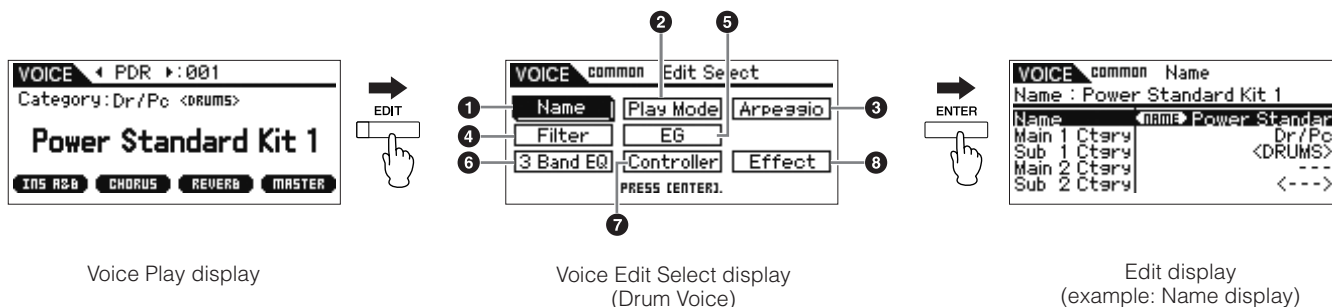

- 1 Name**
This is the same as the Name display in Normal Voice Common Edit (page 65).
- 2 Play Mode**
This is the same as the Play Mode display in Normal Voice Common Edit (page 65). The following settings are not available for Drum Voice: Note Shift settings, Mono/Poly settings, Key Assign mode settings, Portamento settings, Micro tuning settings.
- 3 Arp Select (Arpeggio Select)**
This is the same as the Arp Select display in Normal Voice Common Edit (page 66).
- 4 Filter**
This is the same as the Filter display in Normal Voice Common Edit (page 68).
- 5 EG**
This is the same as the EG display in Normal Voice Common Edit (page 68). The following parameters are not available for Drum Voice: FEG Attack Time, FEG Decay Time, FEG Release Time, FEG Depth, AEG Sustain Level, AEG Release Time.
- 6 3 Band EQ**
This is the same as the 3 Band EQ display in Normal Voice Common Edit (page 71).
- 7 Control**
This is the same as the Control display in Normal Voice Common Edit (page 71). The Element Switch parameters on the MOTIF-RACK XS Editor are not available for Drum Voice.
- 8 Effect**
This is the same as the Effect in Normal Voice Common Edit (page 72). The main difference is that the Insertion Effect Out parameter on the MOTIF-RACK XS Editor is set for each Drum Key. In addition to that, four parameters are available. In this section, we'll describe only those parameters which are different from the Normal Voice.

Key Out (Drum Key Out) 	Determines which Insertion Effect (A or B) is used to process each individual Drum Key, and which is bypassed (thru). This Parameter can be set for each Drum Key selected in the Key parameter. Settings: thru (through), Ins A (Insertion A), Ins B (Insertion B)
Key 	Determines the Drum Key to be edited. You can select the key by clicking the keyboard on the MOTIF-RACK XS Editor. The parameters Key Out, Reverb Send (Key Reverb Send) and Chorus Send (Key Chorus Send) can be set for each Drum Key. Settings: C0 – C6
Chorus Send (Key Chorus Send) 	Determines the level of the Drum Key sound (the bypassed signal) that is sent to Chorus effect. The setting here is available only when the Key Out parameter is set to "thru." Settings: 0 – 127
Reverb Send (Key Reverb Send) 	Determines the level of the Drum Key sound (the bypassed signal) that is sent to Reverb effect. The setting here is available only when the Key Out parameter is set to "thru." Settings: 0 – 127

<p>Chorus Ins Send (Insertion Chorus Send)</p> <p>EDITOR</p>	<p>When the Key Out parameter is set to "Ins A" or "Ins B," this determines the level of the Drum Key sound (output from Insertion Effect A or B) that is sent to the Chorus effect.</p> <p>Settings: 0 – 127</p>
<p>Reverb Ins Send (Insertion Reverb Send)</p> <p>EDITOR</p>	<p>When the Key Out parameter is set to "Ins A" or "Ins B," this determines the level of the Drum Key sound (output from Insertion Effect A or B) that is sent to the Reverb effect.</p> <p>Settings: 0 – 127</p>

Key Edit **EDITOR**

If you wish to edit the sounds that make up a Voice and the detailed parameters that determine the sound, such as Oscillator, Pitch, Filter, Amplitude, and EG (Envelope Generator), call up the Key Edit display. These parameters can be edited only on the MOTIF-RACK XS Editor, and not the device itself. For details on each parameter setting window, refer to the MOTIF-RACK XS Editor Owner's Manual.

OSC (Oscillator)	
<p>Key</p>	<p>Determines the desired drum key. You can also select the key by clicking the keyboard on the MOTIF-RACK XS Editor.</p> <p>Settings: C0 – C6</p>
<p>Key Sw (Key Switch)</p>	<p>Determines whether the currently selected Key is used or not. When this is set to off, the currently edited Key will not sound.</p> <p>Settings: off (inactive), on (active)</p>
<p>Wave Bank Category Number Name</p>	<p>Determines the Waveform assigned to the Drum Key. Only Preset Banks are available for the Waveform Bank. For details about Preset Waveforms, see the Waveform list in the separate Data List.</p>
<p>Assign Mode</p>	<p>This is useful when two or more instances of the same note are received nearly simultaneously, or without a corresponding Note Off message. To allow playback of each instance of the same note, set this to "multi." In general, you should probably set this to "multi"—especially for tambourine and cymbal sounds that you would want to ring out to their full decay, when playing them multiple times in succession. Please keep in mind that the "multi" setting consumes the overall polyphony and it may cause sounds to be cut off.</p> <p>Settings: single, multi</p> <p>single..... When this is set to "single" and double playback of the same note are transmitted to the internal tone generator, the first note will be stopped before the next note is sounded.</p> <p>multi..... When this is set to "multi" and double playback of the same note are transmitted to the internal tone generator, all notes are sounded simultaneously.</p>
<p>Receive Note Off</p>	<p>Determines whether MIDI Note Off messages are received by each Drum Key. This should be set to on when the selected Drum Key has a sustained, non-decaying sound (such as a snare roll), so that you can stop the sound by releasing the note.</p> <p>Settings: off, on</p>
<p>Alternate Group</p>	<p>Sets the Alternate Group to which the Wave is assigned. In a real drum kit, some drum sounds cannot physically be played simultaneously, such as open and closed hi-hats. You can prevent keys from playing back simultaneously by assigning them to the same Alternate Group. You can also select "off" here if you wish to allow the simultaneous playback of sounds.</p> <p>Settings: off, 1 – 127</p>
<p>Ins Effect Output (Insertion Effect Output)</p>	<p>Determines which Insertion Effect (A or B) is used to process each individual Drum Key, and which is bypassed (thru). This parameter is same as Key Out (page 83) in the Effect section in Drum Voice Common Edit. Making a setting here automatically changes the setting of that parameter as well.</p> <p>Settings: thru (through), Ins A (Insertion A), Ins B (Insertion B)</p>
<p>Reverb Send (Key Reverb Send)</p>	<p>Determines the level of the Drum Key sound (the bypassed signal) that is sent to Reverb effect. The setting here is available only when the "Ins Effect Output" parameter is set to "thru." This parameter is same as Reverb Send (page 83) in the Effect section in Drum Voice Common Edit. Making a setting here automatically changes the setting of that parameter as well.</p> <p>Settings: 0 – 127</p>
<p>Chorus Send (Key Chorus Send)</p>	<p>Determines the level of the Drum Key sound (the bypassed signal) that is sent to Chorus effect. The setting here is available only when the "Ins Effect Output" parameter is set to "thru." This parameter is same as Chorus Send (page 83) in the Effect section in Drum Voice Common Edit. Making a setting here automatically changes the setting of that parameter as well.</p> <p>Settings: 0 – 127</p>

Output Select	Determines the specific output(s) for the individual Drum key signal. You can assign each individual Drum key sound to be output from a specific hardware output jack on the rear panel. This parameter is useful when you wish to apply a connected external effect to a specific drum instrument. The setting here is available only when the "Ins Effect Output" parameter is set to "thru." Settings: For details, refer to the "Output Select List" (page 90) of the Supplementary information.
Tune	
Coarse (Coarse Tuning)	Determines the pitch of each Drum Key in semitones. Settings: -48semi – +0semi – +48semi
Fine (Fine Tuning)	Determines the pitch of each Drum Key in cents. Settings: -64 cents – +0 cent – +63 cents
Vel Sens (Pitch Velocity Sensitivity)	Determines how the pitch of the Drum Key responds to velocity. Positive settings will cause the pitch to rise the more strongly you play an external keyboard and negative settings will cause it to fall. A setting of 0 results in no change in pitch. Settings: -64 – +0 – +63
Filter Type	
Cutoff	Raises or lowers the cutoff frequency of the low pass filter to adjust the tone brilliance. The sound can be brightened by raising the cutoff frequency, and darkened or muffled by lowering it. Settings: 0 – 255
Cutoff Vel Sens (Cutoff Velocity Sensitivity)	Determines how the Cutoff Frequency responds to velocity, or the strength with which you play notes. Positive settings will cause the Cutoff Frequency to rise the harder you play an external keyboard. A setting of 0 will cause the Cutoff Frequency not to change depending on velocity. Negative settings will cause the Cutoff Frequency to rise the more softly you play. Settings: -64 – +0 – +63
Resonance	Determines the emphasis given to the Cutoff Frequency to add further character to the sound. Higher values result in a more pronounced effect. This can be used in combination with the cutoff frequency parameter to add further character to the sound. Settings: 0 – 127
HPF Cutoff (High Pass Filter Cutoff Frequency)	Determines the Cutoff Frequency of the High Pass Filter. The sound can be brightened by raising the cutoff frequency, and darkened or muffled by lowering it. Settings: 0 – 255
AMP Level/Pan	
Level	Determines the output level of the Drum Key. Settings: 0 – 127
Velocity Sens (Level Velocity Sensitivity)	Determines how the output level of the Drum Key responds to velocity. Positive settings will cause the output level to rise the harder you play an external keyboard. A setting of 0 will cause the output level not to change. Negative settings will cause the output level to rise the more softly you play an external keyboard. Settings: -64 – +0 – +63
Pan	Adjusts the stereo pan position of the sound. Settings: L63 (far left) – C (center) – R63 (far right)
Alternate Pan	Determines the amount by which the sound is panned alternately left and right for each received Note On message, assuming the pan position set above as center. Higher values increase the width of the Pan range. Settings: L63 – C – R63
Random Pan	Determines the amount by which the sound of the selected Drum Key is panned randomly left and right for each received Note On message. The Pan setting (above) is used as the Center Pan position. Settings: 0 – 127

AEG (Amplitude EG)

Time

Determines the AEG transition time. A higher value results in a longer time until reaching the next level.

Settings: 0 – 127 (0 – 126, hold for Decay 2 Time)

Attack (Attack Time)

Determines how quickly the sound reaches its maximum level after a Note On message is received.

Decay 1 (Decay 1 Time)

Determines how fast the envelope falls from the Attack Level to the Decay 1 Level.

Decay 2 (Decay 2 Time)

Determines how quickly the sound decays from the Decay 1 Level to silence after a Note Off message is received.

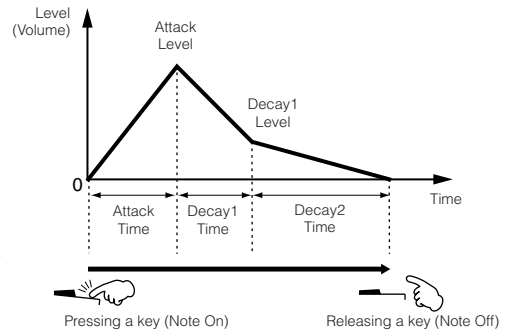

Level

Determines the Level settings for the Amplitude EG. The Level parameters let you set the amount of the transition at each point based on the level specified in the AMP Level/Pan parameter (page 85).

Settings: 0 – 127

Decay 1 Level

Determines the level which the AEG reaches from the Attack Level after the Decay 1 Time elapses.

EQ

From this display, you can set the EQ parameters for each Drum Key. This is the same as the EQ section in Normal Voice Element Edit (page 81).

The Controls & Connectors

Setting Up

Listening to the Sound

Connections

Using a Computer

Quick Guide

Basic Structure

Voice

Multi

Utility

Appendix

Supplementary information

Category List

This is the list of the Main Categories and their Sub Categories to which the respective Voices of the MOTIF-RACK XS belong.

Main Category	Sub Category				
Piano (Acoustic Piano)	APno (Acoustic Piano)	Layer	Modrn (Modern)	Vintg (Vintage)	Arp (Arpeggio)
Keys (Keyboard)	EP (Electric Piano)	FM (FM Piano)	Clavi	Synth	Arp
Organ	Tn Whl (Tone Wheel)	Combo	Pipe	Synth	Arp
Guitar	A. Gtr (Acoustic Guitar)	E.Cln (Electric Clean)	E. Dst (Electric Distortion)	Synth	Arp
Bass	ABass (Acoustic Bass)	EBass (Electric Bass)	SynBs (Synth Bass)	Arp (Arpeggio)	—
String (Strings)	Solo	Ensem (Ensemble)	Pizz (Pizzicato)	Synth	Arp
Brass	Solo	BrsEn (Brass Ensemble)	Orche (Orchestra)	Synth	Arp
SaxWW (Sax / Woodwind)	Sax (Saxophone)	Flute	WWind (Woodwind)	RPipe (Reed / Pipe)	Arp
SynLd (Synth Lead)	Analg (Analog)	Digitl (Digital)	H Hop (Hip Hop)	Dance	Arp
Pads (Synth Pad/Choir)	Analg (Analog)	Warm	Brite (Bright)	Choir	Arp
SyCmp (Synth Comp)	Analg (Analog)	Digitl (Digital)	Fade	Hook	Arp
CPerc (Chromatic Percussion)	Malet (Mallet Percussion)	Bell	SynBl (Synth Bell)	PDrum (Pitched Drum)	Arp
Dr / Pc (Drum / Percussion)	Drums	Perc (Percussion)	Synth	Arp (Arpeggio)	—
S.EFX (Sound Effect)	Move (Moving)	Ambie (Ambient)	Natur (Nature)	SciFi (Sci-Fi)	Arp
M. EFX (Musical Effect)	Move	Ambie	Sweep	Hit	Arp
Ethnc (Ethnic)	Bowed	Pluk (Plucked)	Struk (Struck)	Blown	Arp

Micro Tuning

In the sections that follow, we'll explain in detail about the "Micro Tune" parameter in the Play Mode display (page 66) of the Voice Common Edit parameters.

What is Micro Tuning?

This function lets you change the keyboard scale from normal tuning (equal temperament) to one of a variety of special scales. You can determine the scale type for each voice by simply selecting a Tuning number. You can also use original Micro Tuning types that you've created in the Micro Tune display (page 102) of the Utility parameters.

Micro Tuning List

Micro Tuning No.	Type	Micro Tuning Root	Comments
1	Equal	—	The "compromise" tuning used for most of the last 200 years of Western music, and found on most electronic keyboards. Each half step is exactly 1/12 of an octave, and music can be played in any key with equal ease. However, none of the intervals are perfectly in tune.
2	PureMajor	C – B	This tuning is designed so that most of the intervals (especially the major third and perfect fifth) in the major scale are pure. This means that other intervals will be correspondingly out of tune. You need to specify the key (C – B) you will be playing in.
3	PureMinor	C – B	The same as Pure Major, but designed for the minor scale.
4	Werckmeister	C – B	Andreas Werckmeister, a contemporary of Bach, designed this tuning so that keyboard instruments could be played in any key. Each key has a unique character.
5	Kirnberger	C – B	Johann Philipp Kirnberger, an 18th century composer, created this tempered scale to allow performances in any key.
6	Vallot&Yng	C – B	Francescantonio Vallotti and Thomas Young (both mid-1700s) devised this adjustment to the Pythagorean tuning, in which the first six fifths are lowered by the same amount.
7	1/4 Shift	—	This is the normal equal tempered scale shifted up 50 cents.
8	1/4 tone	—	Twenty-four equally spaced notes per octave. (Play twenty-four notes to move one octave.)
9	1/8 tone	—	Forty-eight equally spaced notes per octave. (Play forty-eight notes to move one octave.)
10	Indian	—	Usually observed in Indian music (white keys only).
11	Arabic 1	C – B	Usually observed in Arabic music.
12	Arabic 2		
13	Arabic 3		

Setting examples of the Destination

In this section, we'll show you some useful examples how to set the "Ctrl Set 1 – 6 Dest (Controller Set Destination)" assignments of the Control display in the Voice Common Edit parameters (page 71).

To control the volume:	Volume (volume)
To apply vibrato to the Voice:	Common LFO Depth1 – 3 (C-LFO dpth1 – 3) *1
To change the pitch:	Element Pitch (coarse tune) *2
To control the brightness of the Voice:	Element Filter Frequency (cutoff) *2
To change the speed of the Rotary Speaker:	Insertion A/B Parameter 1 (ins A/B Rotor Slow) *3
To apply wah pedal effect to the Voice:	Insertion A/B Parameter 1 (ins A/B Pedal Ctrl) *4

Concerning *1 – *4, the following settings are necessary in addition to the above setting.

- *1
 - Select the "LFO" in the Voice Edit Select display → [ENTER] → "Play Mode" = "loop"
 - Select the "LFO" in the Voice Edit Select display → [ENTER] → "LFO Set 1 – 3 Dest" = "P mod"
- *2
 - Controller Set in the Voice Common Edit on the MOTIF-RACK XS Editor → "SW (Element Switch)" = "on"
- *3
 - Select the "Effect" in the Voice Common Select display → [ENTER] → select the "Ins A/B" → [ENTER] → "Type" = "Rotary Speaker"
 - Effect in the Voice Common Edit on the MOTIF-RACK XS Editor → "Element Out" / "Key Out" = ins A/B (assigned to "Rotary Speaker" type)
- *4
 - Select the "Effect" in the Voice Common Select display → [ENTER] → select the "Ins A/B" → [ENTER] → "Type" = "VCM Pedal Wah"
 - Effect in the Voice Common Edit on the MOTIF-RACK XS Editor → "Element Out" / "Key Out" = ins A/B (assigned to "VCM Pedal Wah")

Filter Type List **EDITOR**

In the sections that follow, we'll explain the Filter Type specified in the Filter Type display of the Voice Element Edit.

LPF (Low Pass Filter)

This is a Filter type that only passes signals below the Cutoff Frequency. The sound can be brightened by raising the cutoff frequency of the filter. On the other hand, the sound can be darkened by lowering the cutoff frequency of the filter. You can then use Resonance to add further character to the sound. This filter type is most popular and useful for producing classic synthesizer sounds.

LPF24D

Compared to the LPF24A type (below), this filter can produce a more pronounced resonance effect.

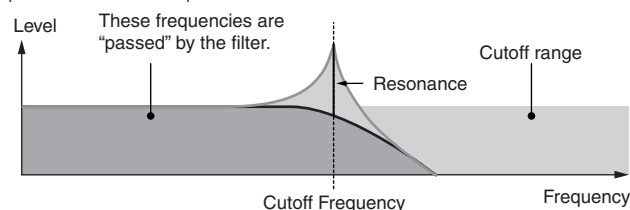

LPF24A

A digital dynamic low-pass filter with characteristics similar to a 4-pole analog synthesizer filter.

LPF18

3-pole 18 dB/oct low-pass filter.

LPF18s

3-pole 18 dB/oct low-pass filter. This filter has a smoother cutoff slope than the LPF18 type.

HPF (High Pass Filter)

This is a Filter type that only passes signals above the Cutoff Frequency. You can then use the Resonance to add further character to the sound.

HPF24D

A dynamic 24 dB/oct high-pass filter with a characteristic digital sound. This filter can produce a pronounced resonance effect.

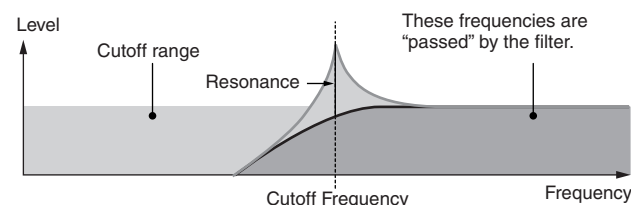

HPF12

12 dB/oct dynamic high-pass filter.

BPF (Band Pass Filter)

This Filter type is a combination of a LPF and HPF. When this Filter Type is selected, you can set the Cutoff Frequency around which the audio signal is passed.

BPF12D

The combination of a -12 dB/oct HPF and LPF with a characteristic digital sound.

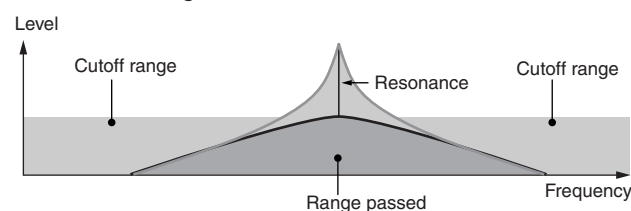

BPF6

The combination of a -6 dB/oct HPF and LPF.

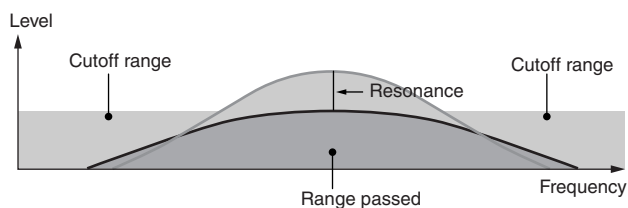

BPFw

A 12 dB/oct BPF that combines HPF and LPF filters to allow wider bandwidth settings.

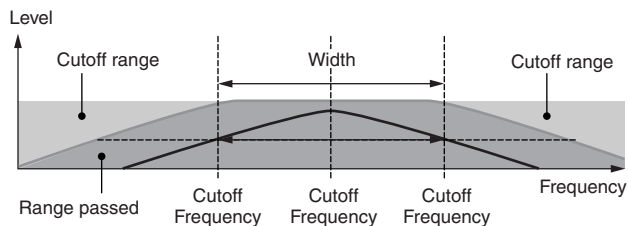

BEF (Band Elimination Filter)

When this Filter Type is selected, you can set the Cutoff Frequency around which the audio signal is muted or eliminated. The Band Elimination Filter has an opposite effect on the sound compared to the Band Pass Filter.

BEF12

BEF6

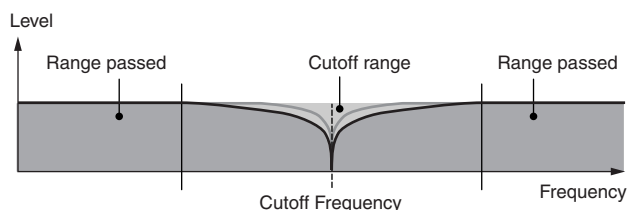

Dual Type Filter

This type is a combination of two same filter types. You can edit the distance between the two Cutoff Frequencies.

Dual LPF

Two 12 dB/oct low-pass filters connected in parallel.

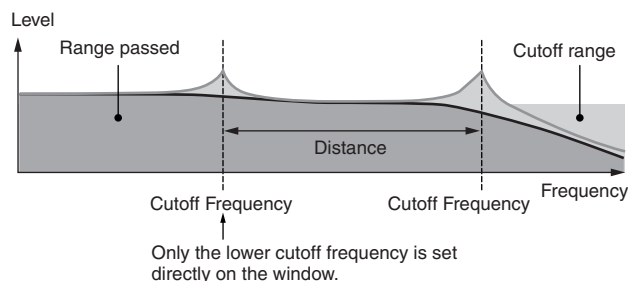

Dual HPF

Two -12 dB/oct high-pass filters connected in parallel.

Dual BPF

Two -6 dB/oct band-pass filters connected in parallel.

Dual BEF

Two -6 dB/oct band-elimination filters connected in parallel.

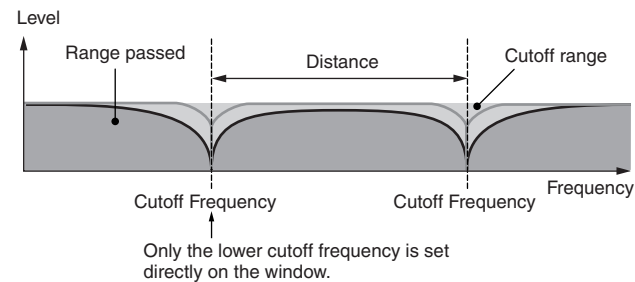

Combination Type Filter

This type is a combination of two different filter types. You can edit the distance between the two Cutoff Frequencies.

LPF12+HPF12

A combination of a -12 dB/oct low-pass filter and high-pass filter. When this Filter Type is selected, HPF Cutoff and HPF Key Follow can be set. Only the LPF graph is shown on the window.

LPF6+HPF6

A combination of a -6 dB/oct low-pass filter and high-pass filter. When this Filter Type is selected, HPF Cutoff and HPF Key Follow can be set. Only the LPF graph is shown on the window.

LPF12+BPF6

A combination of a low-pass filter and band-pass filter. You can edit the distance between the two Cutoff Frequencies.

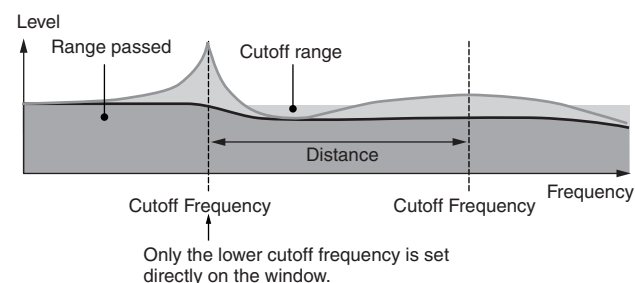

The Controls & Connectors

Setting Up

Listening to the Sound

Connections

Using a Computer

Quick Guide

Basic Structure

Voice

Reference

Multi

Utility

Appendix

Setting example of Filter Scaling EDITOR

Here we'll show you the setting example of Filter Scaling in Filter Scale (page 78) of the Voice Element Edit parameters. For the settings shown in the example below, the basic Cutoff frequency value is 127, and the various Cutoff Offset values at the selected Break Point settings change that basic value accordingly. The specific changes to the Cutoff frequency are shown in the diagram below. The Cutoff frequency changes in a linear fashion between successive Break Points across the keyboard as shown.

	1	2	3	4
Break Point	C#1	D#2	C3	C4
Cutoff Offset	-4	+10	+17	+4

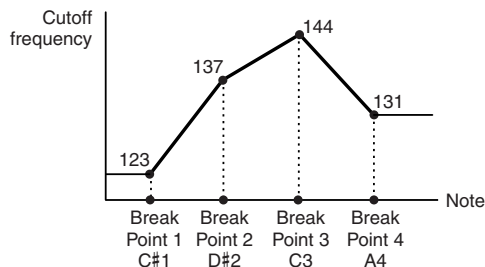

Setting example of Amplitude Scaling EDITOR

Here we'll show you an example Amplitude Scaling setting in AMP Scale (page 81) of the Voice Element Edit parameters. For the settings shown in the example below, the basic Amplitude (volume) value for the selected Element is 80, and the various Level Offset values at the selected Break Point settings change that basic value accordingly. The Amplitude changes in a linear fashion between successive Break Points across the keyboard as shown.

	1	2	3	4
Break Point	C1	C2	C3	C4
Level Offset	-4	+10	+17	+4

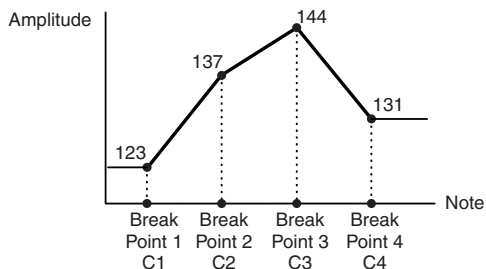

Output Select List EDITOR

In the sections that follow, we'll explain the Output Select settings that let you determine the output assignments for the signals. Output Select is specified in several different places: OSC (Oscillator) of the Drum Key Edit parameters (page 85) on the MOTIF-RACK XS Editor, the mLAN In display of the Multi Common Edit parameter (page 92), the Play Mode display of the Multi Part Editor parameters (page 95), and the Voice mLAN display of the Utility parameters.

LCD	Output jacks	Stereo/Mono
L&R	OUTPUT L and R	Stereo
asL&R	ASSIGNABLE OUTPUT L and R	Stereo
m1&2	mLAN OUTPUT 1 and 2	Stereo (1: L, 2: R)
m3&4	mLAN OUTPUT 3 and 4	Stereo (3: L, 4: R)
m5&6	mLAN OUTPUT 5 and 6	Stereo (5: L, 6: R)
m7&8	mLAN OUTPUT 7 and 8	Stereo (7: L, 8: R)
m9&10	mLAN OUTPUT 9 and 10	Stereo (9: L, 10: R)
m11&12	mLAN OUTPUT 11 and 12	Stereo (11: L, 12: R)
m13&14	mLAN OUTPUT 13 and 14	Stereo (13: L, 14: R)
asL	ASSIGNABLE OUTPUT L	Mono
asR	ASSIGNABLE OUTPUT R	Mono
m1	mLAN OUTPUT 1	Mono
:	:	:
m14	mLAN OUTPUT 14	Mono
drum	See below*	See below*

*About "drum" setting, see below.

The "drum" setting can be selected in the Multi Part Edit display of the Parts assigned to the Drum Voice. When "drum" is selected and the Drum Voice is assigned to the edited Part, the sound will be output via the destination set in the Drum Key Edit window as the "Output Select" parameter.

NOTE The mLAN Inputs (m1 – m14) are available only when an optional mLAN16E2 has been installed.

Multi Mode

Multi Edit

This section covers the Multi Edit parameters. Multi Edit consists of the Common Edit parameters for editing the settings common to all Parts, and Part Edit parameters for editing the individual Parts.

Common Edit

Common Edit lets you edit the parameters common to all Parts of the selected Multi.

Procedure

[MULTI] → Select Multi programs → [EDIT] → Select the “Common” in the Multi Edit Select display → [ENTER] → Select the desired display in the Multi Common Edit Select display → [ENTER] → Edit display

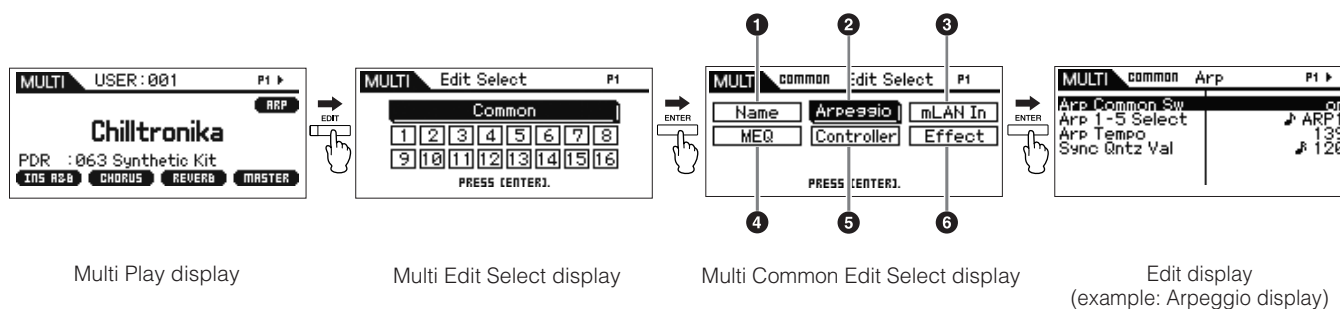

1 Name

Name
(Multi Name)

Determines the name of the current edited Multi. When you move the cursor to “Name,” pressing the [ENTER] button calls up the Naming dialog, allowing you to enter the desired name. The Voice name can contain up to 20 characters. For detailed instructions on naming, refer to page 47 in the Quick Guide.

2 Arpeggio

Arp Common Sw
(Arpeggio Common Switch)

Determines whether Arpeggio playback is on or off. You can also turn this on or off from the front panel with the [AUDITION] button when the “Audition Button” (page 99) in the Utility General window is set to “arpeggio sw.”

Settings: off, on

Arp 1 – 5 Select
(Arpeggio 1 – 5 Select)

Select the desired Arpeggio from Arpeggios 1 – 5. This parameter is same as the “Arp Select” on the Arp Select display in the Multi Part Edit. The 8th note icon shown in the settings indicates that one of the Arpeggio Types (other than “off”) is selected for the Arpeggio.

Settings: Arp 1 – Arp 5

Arp Tempo
(Arpeggio Tempo)

Determines the Arpeggio Tempo. This parameter can be changed directly via the Knob.

Settings: 5 – 300

NOTE If you are using this instrument with an external sequencer, DAW software, or MIDI device, and you want to synchronize it with that device, set the MIDI Sync parameter in the Utility MIDI window (page 99) to “external” or “auto.” When MIDI Sync is set to “auto” (only when MIDI clock is transmitted continuously) or “external,” the Tempo parameter here indicates “external” and cannot be changed.

Sync Qntz Val
(Sync Quantize Value)

Determines the actual timing at which the next Arpeggio playback starts when you trigger it while the Arpeggio of a certain Part is played back. When set to “off,” the next Arpeggio starts as soon as you trigger it. The number shown at right of each value indicates the length assumes that the quarter-note resolution is 480.

Settings: off, 60 (32nd note), 80 (16th note triplet), 120 (16th note), 160 (8th note triplet), 240 (8th note), 320 (1/4 note triplet), 480 (1/4 note)

3 mLAN In

These parameters let you make audio input settings for the mLAN terminal.

Volume

Determines the output level of the Audio Input Part.

Settings: 0 – 127

Pan

Determines the stereo pan position of the Audio Input Part.

Settings: L63 (far left) – C (center) – R63 (far right)

<p>Mono / Stereo</p>	<p>Determines the signal configuration for the Audio Input Part, or how the signal or signals are routed (stereo or mono). Settings: L mono, R mono, L+R mono, stereo L mono Only the L channel of the audio input is used. R mono Only the R channel of the audio input is used. L+R mono The L and R channels of the audio input are mixed and processed in mono. stereo Both the L and R channels of the audio input are used.</p>
<p>Output Select</p>	<p>Determines the specific output(s) for the Audio Input Part signal. Settings: For details, refer to Output Select List (page 90) of the Supplementary information.</p>
<p>Chorus Send (Key Chorus Send)</p>	<p>Determines the Send level of the Audio Input Part signal sent to the Chorus effect. The higher the value, the more pronounced the Chorus. This parameter can be set only when "Output Select" is set to "L&R." Settings: 0 – 127</p>
<p>Reverb Send (Key Reverb Send)</p>	<p>Determines the Send level of the Audio Input Part signal sent to the Reverb effect. The higher the value, the more pronounced the Reverb. This parameter can be set only when "Output Select" is set to "L&R." Settings: 0 – 127</p>
<p>Dry Level</p>	<p>Determines the level of the Audio Input Part which has not been processed with the System Effects (Reverb, Chorus). This parameter can be set only when "Output Select" is set to "L&R." Settings: 0 – 127</p>

4 MEQ (Master EQ)

From this display you can apply five-band equalization to all parts of the selected Multi.

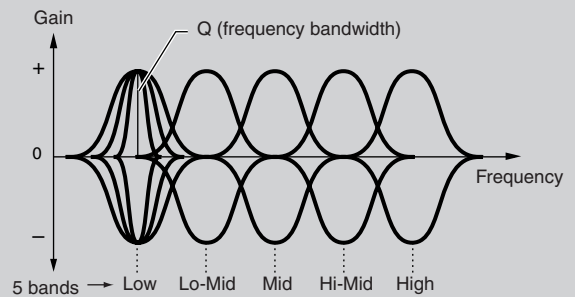

Shape

Enables you to select one of two equalizer shapes: shelving or peaking. This parameter is available for Low and High.

Settings: shelv (shelving type), peak (peaking type)

shelv

This type of EQ shape lets you attenuate/boost the signal at frequencies above or below the specified Frequency setting.

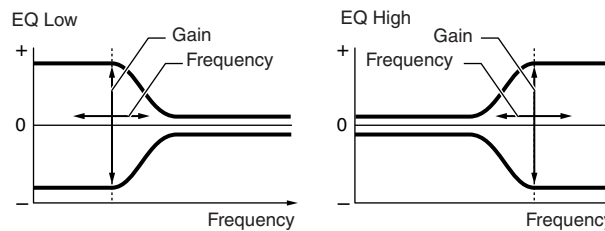

peak

This type of EQ shape lets you attenuate/boost the signal at the specified Frequency setting.

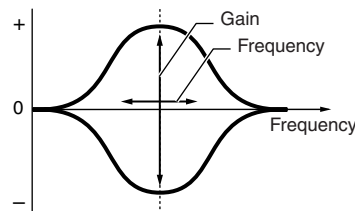

**Freq
(Frequency)**

Frequencies around this point are attenuated /boosted by the "Gain" setting below.

Settings:

Low
 When the Shape is set to "shelv": 32Hz – 2.0kHz
 When the Shape is set to "peak": 63Hz – 2.0kHz

Lo-Mid, Mid, Hi-Mid
 100 Hz – 10.0 kHz

High
 500 Hz – 16.0 kHz

Gain	Determines the level gain for the Frequency (set above), or the amount the selected frequency band is attenuated or boosted. Settings: -12.00 dB – +0.00 dB – +12.00 dB
Q (Bandwidth)	This varies the signal level at the Frequency setting to create various frequency curve characteristics. The higher the setting the smaller the Q (Bandwidth). The lower the setting, the greater the Q (Bandwidth). Settings: 0.1 – 12.0 NOTE When the Shape parameters of the Low and High are set to "shelv," the "Q" parameters of Low and High are not available.

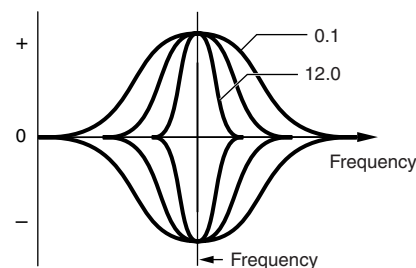

5 Control

Assign 1 Value Assign 2 Value	Determines the offset value by which the functions assigned to the Assign 1/2 knobs will be shifted from their original settings. Each parameter can be changed directly via the Knob. Settings: -64 – +0 – +63 NOTE The functions assigned to the Assign 1/2 Knobs can be set in "Ctrl Set 1 – 6 Src" (page 71) of the Control display.
----------------------------------	--------------------------------------------------------------------------------------------------------------------------------------------------------------------------------------------------------------------------------------------------------------------------------------------------------------------------------------------------------------

6 Effect

NOTE This display can be called up by pressing and holding the [EFFECT] button on the front panel.

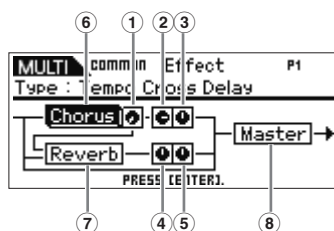

① Chorus To Reverb	Determines the Send level of the signal sent from the Chorus Effect to the Reverb Effect. The higher the value, the deeper the Reverb that is applied to the Chorus-processed signal. Settings: 0 – 127
② Chorus Return	Determines the Return level of the Chorus Effect. Settings: 0 – 127
③ Chorus Pan	Determines the pan position of the Chorus effect sound. Settings: L63 (far left) – C (center) – R63 (far right)
④ Reverb Return	Determines the Return level of the Reverb Effect. Settings: 0 – 127
⑤ Reverb Pan	Determines the pan position of the Reverb effect sound. Settings: L63 (far left) – C (center) – R63 (far right)
⑥ Chorus ⑦ Reverb ⑧ Master	When the cursor is located here, pressing the [ENTER] button or the Encoder knob calls up the Effect Parameter display.

Effect Parameters

Switch	This parameter is available only for Master Effect. Settings: off, on
Category Type	From the Category column, you can select one of the Effect Categories, each of which contains similar Effect types. From the Type column, you can select one of the Effect Types listed in the selected Category. Settings: Details about the Effect categories and the Effect types are described on page 59. NOTE The "Category" is not edited in the Reverb and the Master effect parameter display because there is only one Reverb/Master category.
Preset	This lets you call up pre-programmed settings for each Effect Type, designed to be used for specific applications and situations. NOTE For details about "Preset" settings, refer to the separate Data List booklet.
Effect Parameter 1 – 16	The effect parameter differs depending on the currently selected effect type. Refer to page 61 for details about the Effect parameters. Refer to the separate Data List booklet for information on the parameters for each Effect type.

Part Edit

Part Edit lets you edit the parameters of the individual Parts that make up a Multi.

Procedure

[MULTI] → Select Multi programs → [EDIT] → Select the desired Part “1” – “16” in the Multi Edit Select display → [ENTER] → Select the desired display in the Multi Part Edit Select display → [ENTER] → Edit display

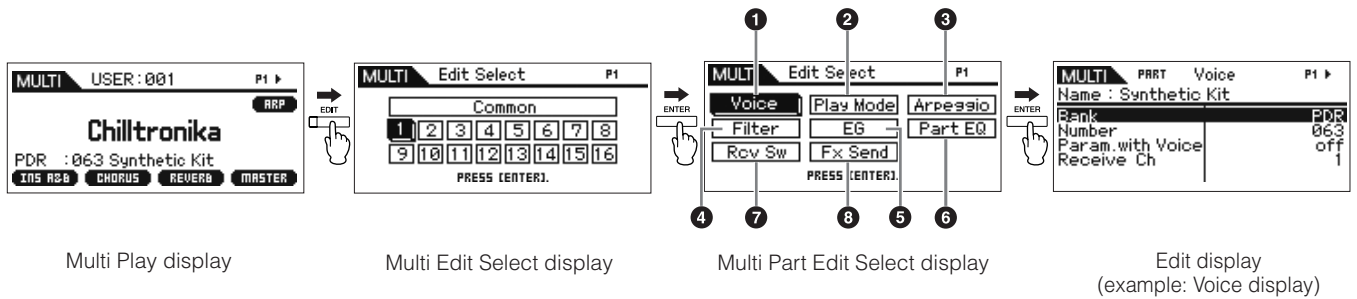

1 Voice

Bank Number	Determines the Voice assigned to the current Part by specifying the Voice Bank and Number.
Param. with Voice (Parameter with Voice)	Determines whether or not the following parameter settings of the selected Voice are copied from the Voice to the current Part when you change a Voice for the current Part individually. <ul style="list-style-type: none"> • Arpeggio settings • Filter Cutoff Frequency • Filter Resonance • Amplitude EG • Filter EG • Pitch Bend Range (Upper/Lower) • Note Shift <p>NOTE Regardless of the Parameter with Voice setting, the following settings are always copied when a Normal Voice is selected: Mono/Poly, Porta Sw (Portamento Part Switch), Porta Time (Portamento Time) and Porta Mode (Portamento Mode).</p> <p>Settings: off (not copied), on (copied)</p>
Receive Ch (Receive Channel)	Determines the MIDI receive channel for the selected Part. Since MIDI data may be coming from many channels at once, you should set this to match the particular channel over which the desired controlling data is being sent. The MIDI transmit channel for the real-time changing of the Knob-controlled data is the same as this parameter setting. <p>Settings: 01 – 16, off</p>

2 Play Mode

Volume	Determines the volume for each Part. Use this parameter to adjust the balance between the current Part and other Parts. This parameter can be changed directly via the Knob. <p>Settings: 0 – 127</p>
Pan	Determines the stereo pan position for the Part. This parameter can be changed directly via the Knob. <p>Settings: L63 (far left) – C (center) – R63 (far right)</p> <p>NOTE Note that this Part Pan parameter may have little or no audible effect if the Pan for a specific Element is set to the left position and the Pan for another Element is set to the right position.</p>
Voice Elm Pan (Voice Element Pan)	Determines whether the individual pan settings for each Element (of the Voice assigned to the selected Part) are applied or not. When this is set to “off,” the pan position for the each Element is set to center in the Part. <p>Settings: on, off</p>
Note Shift	Adjusts the pitch of the Part in semitones. <p>Settings: 24 – +0 – +24</p>
Detune	Adjusts the tuning of the Part in cent increments. <p>Settings: -12.8Hz – +0Hz – +12.7Hz</p>
PB Range Upper (Pitch Bend Range Upper) PB Range Lower (Pitch Bend Range Lower)	Determines the maximum Pitch Bend range in semitones. Setting the Upper parameter to +12 would result in a maximum pitch rise of one octave when the Pitch Bend wheel is moved upwards. On the other hand, a Lower setting of -12 would result in the pitch being lowered up to a maximum of one octave (12 semitones) when the Pitch Bend wheel is moved downwards. <p>Settings: -48 semi – +0 semi – +24 semi</p>

<p>Mono/Poly</p>	<p>Determines the playback method of the Voice for each Part: monophonic (single note only) or polyphonic (multiple notes).</p> <p>Settings: mono, poly</p> <p>monoWhen set to "mono," the selected Voice is played back monophonically (only a single note is played back simultaneously). For many instrument sounds (such as bass and synth lead), this allows a more natural and smooth sounding legato performance than when this parameter is set to "poly."</p> <p>poly.....When set to "poly," the selected Voice is played back polyphonically (multiple notes can be played back simultaneously or a chord is played back).</p>
<p>Note Limit Lo/Hi</p>	<p>Determines the lowest and highest notes of the keyboard range for each Part. Each Part will only sound for notes played within its specified range. For example, setting a Note Limit of "C5 – C4" lets you play the Element from two separate ranges: C -2 to C4 and C5 to G8. Notes played between C4 and C5 do not play the selected Element.</p> <p>Settings: C -2 – G8</p>
<p>Velocity Limit Lo/Hi</p>	<p>Determines the minimum and maximum values of the velocity range within which each Part will respond. Each Part will only sound for notes played within its specified velocity range. If you specify the maximum value first and the minimum value second, for example "93 to 34," there will be a velocity "hole" and the velocity range covered will be "1 to 34" and "93 to 127."</p> <p>Settings: 1 – 127</p>
<p>Porta Sw (Portamento Switch)</p>	<p>Determines whether Portamento is applied to the current Part or not. This parameter can be changed directly via the Knob.</p> <p>Settings: off, on</p>
<p>Porta Time (Portamento Time)</p>	<p>Determines the pitch transition time when Portamento is applied. Higher values result in a longer pitch change time, or a slow speed. This parameter can be changed directly via the Knob.</p> <p>Settings: 0 – 127</p>
<p>Porta Mode (Portamento Mode)</p>	<p>Determines how Portamento is applied to your keyboard performance.</p> <p>Settings: fingered, fulltime</p> <p>fingeredPortamento is only applied when you play legato (playing the next note before releasing the previous one).</p> <p>fulltimePortamento is applied to all notes.</p>
<p>Output Select</p>	<p>Determines the specific output(s) for the individual Part signal. You can assign each individual Part sound to be output from a specific hardware output jack on the rear panel.</p> <p>Settings: For details, refer to Output Select List (page 90) of the Supplementary information.</p>
<p>Vel Sens Depth (Velocity Sensitivity Depth)</p>	<p>Determines the degree to which the resulting volume of the tone generator responds to your playing strength. The higher the value, the more the volume changes in response to your playing strength (as shown at the right). When this is set to 0, the volume remains the same no matter how strongly or softly you play. This would be useful, for example, for authentic playing of an Organ Voice.</p> <p>Settings: 0 – 127</p> <div data-bbox="938 1093 1455 1391" style="text-align: right;"> <p>When Offset (below) is set to 64:</p> <p>The graph shows four linear lines starting from the origin (0,0). The lines represent Depth values of 0, 32, 64, and 127. The y-axis is 'Actual resulting velocity (affecting the tone generator)' and the x-axis is 'Played velocity'. Both axes range from 0 to 127. The line for Depth = 0 is a horizontal line at y=0. The line for Depth = 32 reaches y=32 at x=127. The line for Depth = 64 reaches y=64 at x=127. The line for Depth = 127 reaches y=127 at x=127.</p> </div>
<p>Vel Sens Offset (Velocity Sensitivity Offset)</p>	<p>Determines the amount by which played velocities are adjusted for the actual resulting velocity effect. This lets you raise or lower all velocities by the same amount—allowing you to automatically compensate for playing too strongly or too softly. If the result is 1 or less, the value is set to 1. If the result is higher than 127, the value is set to 127.</p> <p>Settings: 0 – 127</p> <div data-bbox="831 1429 1442 2018" style="text-align: right;"> <div style="display: flex; justify-content: space-around;"> <div data-bbox="831 1429 1123 1715"> <p>When Depth (above) = 64 and Offset = 32</p> <p>The graph shows a line that is zero until played velocity reaches 32, then increases linearly to reach 127 at played velocity 127.</p> </div> <div data-bbox="1145 1429 1442 1715"> <p>When Depth (above) = 64 and Offset = 96</p> <p>The graph shows a line that increases linearly from 96 at played velocity 0 to 127 at played velocity 64, then remains constant at 127 for played velocities up to 127.</p> </div> </div> <div data-bbox="831 1733 1123 2018" style="text-align: center;"> <p>When Depth (above) = 64 and Offset = 64</p> <p>The graph shows a line that increases linearly from 64 at played velocity 0 to 127 at played velocity 127.</p> </div> </div>

The Controls & Connectors

Setting Up

Listening to the Sound

Connections

Using a Computer

Quick Guide

Basic Structure

Voice

Reference

Multi

Utility

Appendix

3 Arp Select (Arpeggio Select)

Determines whether the item being edited will commonly affect all five Arpeggios assigned to each Voice (“Arp Edit”), or affect only the selected Arpeggio (“Arp 1 – 5 Type”). The parameters other than the parameters listed below are same as the corresponding parameters in the Arp Select display (page 66) in Voice Common Edit.

NOTE The Arpeggio tempo can be set in the Arpeggio display (page 91) of Multi Common Edit.

Arp Edit (Arpeggio Edit)

Arp MIDI Out Sw (Arpeggio MIDI Output Switch)	Determines whether Arpeggio playback data is output to the external devices as MIDI messages. When this is set to on, the data is output. Settings: off (not output), on (output)
Arp Transmit Ch (Arpeggio Transmit Channel)	Determines the MIDI transmit channel for Arpeggio playback data. When this is set to “rcv ch (receive channel),” Arpeggio playback data is output via the same MIDI channel (transmit) set in the Receive Ch parameter (page 94) in the Voice display of Multi Part Edit. Settings: 1 – 16, rcv ch (receive channel)
Voice with Arp (Voice with Arpeggio)	Each Arpeggio type is assigned a specific Voice best suited to the type. This parameter determines whether or not the appropriate Voice registered to each Arpeggio type is assigned to the edited Part. When set to “on,” the appropriate Voice is assigned to the edited Part in place of the currently assigned Voice. When set to “off,” the appropriate Voice is not assigned to the edited Part. The currently assigned Voice is maintained. Settings: off (not copied), on (copied)

Arp 1 – 5 Type (Arpeggio 1 – 5 Type)

When the Voice with Arp parameter set to “on” in the Arp Edit display of Multi Part Edit, changing the Main Category, Sub Category, and Type parameters in this display result in displaying the resultant Bank, Number, Name of the Part Voice as popup window.

4 Filter

The settings made here will be applied as offsets to the Filter settings of each Element set for each Part Voice.

Cutoff	Determines the common offset value of filter Cutoff Frequencies for all Elements set to each Part Voice. This parameter can be changed directly via the Knob. Settings: -64 – +0 – +63
Resonance	This parameter’s function varies according to the selected Filter Type. If the selected filter is an LPF, HPF, BPF (excluding the BPFw), or BEF, this parameter is used to set the Resonance. If the selected filter is a BPFw, this parameter is used to adjust the frequency bandwidth. Resonance is used to set the amount of Resonance (harmonic emphasis) applied to the signal at the cutoff frequency. This can be used in combination with the cutoff frequency parameter to add further character to the sound. The Width parameter is used to adjust the width of the band of signal frequencies passed by the filter with the BPFw. The settings made here will be applied as offsets to the same parameters in the Filter display (page 68) of Voice Common Edit. This parameter can be changed directly via the Knob. Settings: -64 – +0 – +63

5 EG

FEG Attack FEG Decay FEG Release FEG Depth AEG Attack AEG Decay AEG Sustain AEG Release	Determines the basic EG settings, both volume and filter, for the selected Part. The parameter values offset the same parameters of the assigned Element set in Voice Element Edit. For details about AEG/FEG, refer to the EG display (page 68) in Voice Common Edit. However in the case of the Drum Voices, only AEG Attack and AEG Decay are available. Each of the AEG parameters and FEG Depth can be changed directly via the Knob. Settings: -64 – +0 – +63
--------------------------------------------------------------------------------------------------------------	-------------------------------------------------------------------------------------------------------------------------------------------------------------------------------------------------------------------------------------------------------------------------------------------------------------------------------------------------------------------------------------------------------------------------------------------------------------------------------

6 Part EQ

You can apply 3-band parametric EQ to each Part to adjust the sound. The parameter values here offset the same parameters of the assigned Element set in Voice Element Edit. The EQ shapes for Low and High are fixed as shelving types.

Freq	Determines the center frequency. Frequencies around this point are attenuated/boosted by the Gain setting below. Higher values produce higher frequencies. The Mid Freq parameter can be changed directly via the Knob. Settings: Low 50.1Hz – 2.00kHz Mid 139.7Hz – 10.1kHz High 503.8Hz – 14.0kHz
Gain	Determines the level gain for the Frequency (set above), or the amount the selected frequency band is attenuated or boosted. This parameter can be changed directly via the Knob. Settings: -12.00 dB – +0.00 dB – +12.00 dB

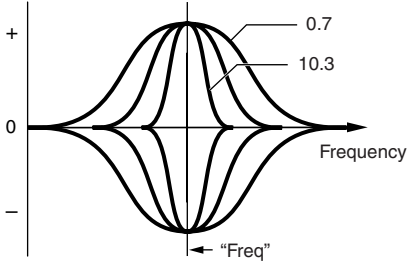
Mid Q (Middle Q)	<p>This varies the signal level at the "Freq" (Frequency) setting to create various frequency curve characteristics. The higher the setting the smaller the Q (Bandwidth). The lower the setting, the greater the Q (Bandwidth). This parameter can be changed directly via the Knob.</p> <p>Settings: 0.7 – 10.3</p>		The Controls & Connectors Setting Up
<p>7 Rcv Sw (Receive Switch)</p> <p>From this display you can set how each individual Part responds to various MIDI data, such as Control Change messages. When the relevant parameter is set to "on," the corresponding Part responds to the appropriate MIDI data. Each of the Controller names in this display indicates the MIDI data generated by using the corresponding Controller.</p> <p>NOTE For Parts to which the Drum Voice is assigned, Sustain is not available.</p> <p>NOTE When the Bank Select Sw/Prg Change Sw is set to "off" in the Utility MIDI window, Bank Select/Program Change here is not available.</p> <p>NOTE If "Control Change" here is set to "off," Control Change related parameters are not available.</p> <p>Settings: off, on</p>			
<p>8 Fx Send (Effect Send)</p>			Connections
Chorus Send	<p>Determines the Send level of the selected Part signal sent to the Chorus effect. The higher the value, the more pronounced the Chorus. This parameter can be changed directly via the Knob.</p> <p>Settings: 0 – 127</p>		
Reverb Send	<p>Determines the Send level of the selected Part signal sent to the Reverb effect. The higher the value, the more pronounced the Reverb. This parameter can be changed directly via the Knob.</p> <p>Settings: 0 – 127</p>		Using a Computer
Dry Level	<p>Determines the level of the selected Part which has not been processed with the System Effects (Reverb, Chorus).</p> <p>Settings: 0 – 127</p>		Quick Guide
Ins Effect Sw (Insertion Effect Switch)	<p>Determines the Parts available for the Insertion Effect. When this switch is set to on, the Insertion Effect of the Voice assigned to the Part is enabled. Make sure that this parameter is set to on for any Parts/Voices to which you need to apply Insertion Effects. The MOTIF-RACK XS features eight Insertion effect systems, letting you set this parameter to on for up to eight Parts. If eight Parts are already turned on, the parameter cannot be turned on for additional Parts.</p> <p>Settings: off, on</p>		Basic Structure

Utility

In the Utility parameters, you can set parameters that apply to the entire system of the MOTIF-RACK XS. Pressing the [UTILITY] button in the Voice or Multi mode calls up the relevant Utility parameters of the current mode. Pressing the [EXIT] button returns to the original display.

Procedure [UTILITY] → Select the desired window in the Utility Select window → [ENTER] → Edit window

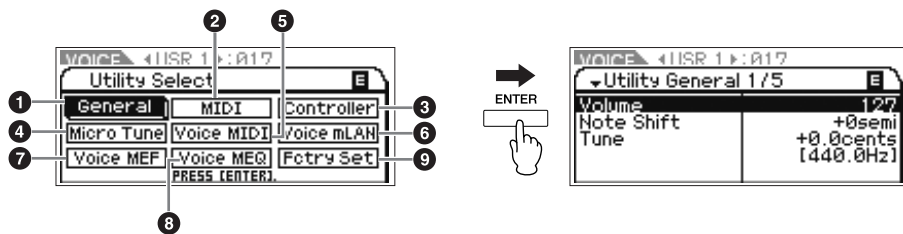

Utility Select window
(when entering from the Voice mode)

Edit window
(example: General window)

1 General

Volume	Determines the overall volume of the instrument. Settings: 0 – 127
Note Shift	Determines the amount (in semitones) by which the pitch of all notes is shifted. Settings: -24semi – +0semi – +24semi
Tune	Determines the tuning of the MOTIF-RACK XS's overall sound. You can adjust the tuning in cent increments. Settings: -102.4cents [414.7Hz] – +0cents [440.0Hz] – +102.3cents [466.8Hz]
mLAN monitor (mLAN monitor switch)	Determines the audio signal flow for monitoring the sound when using the MOTIF-RACK XS with DAW software installed on a computer connected to the MOTIF-RACK XS via an IEEE1394 cable. NOTE You will need to properly set up the DAW software in addition to making the settings here. For details, see the "Connecting to a Computer and MIDI device" on page 17. Settings: stand alone, with PC, with PC (Mntr) stand alone.....When this is selected, the audio signal of the MOTIF-RACK XS will be output directly via the OUTPUT L/ MONO and R jacks normally. This should be selected when you are using the MOTIF-RACK XS alone or are not using the DAW software even with a computer connected to the MOTIF-RACK XS via an IEEE1394 cable. with PCWhen this is selected, the audio signal of the MOTIF-RACK XS will be output to the DAW software on a computer via an IEEE1394 cable, merged and mixed with the DAW sound, returned back to the MOTIF-RACK XS, then output via the OUTPUT L/MONO and R jacks. This should be selected when you are using the MOTIF-RACK XS as an audio device with the DAW software. Selecting this allows you to apply VST Effects within the DAW software to the MOTIF-RACK XS sound. with PC (Mntr).....The audio signal of the MOTIF-RACK XS will be output directly via the OUTPUT L/MONO and R jacks with the audio signal sent from the DAW software via an IEEE1394 cable. This should be selected when recording the MOTIF-RACK XS sound to the DAW software on the computer. Keep in mind that the Rec Monitor of the DAW software should be set to "off" in order to prevent "double" sound from occurring. NOTE When "with PC" is selected, there may be a short delay between when you play an external keyboard and when you hear the resulting sound.
Power on Mode	This determines the default power-on mode (and memory bank)—letting you select which condition is automatically called up when you turn the power on. Settings: multi, voice (USR1), voice (PRE1), voice (GM) multi.....When turning the power on next time, the Multi mode is entered and the first program number (USR: 001) is selected automatically. voice (USR1)When turning the power on next time, the Voice mode is entered and the first program number of the User Voices (USR: 001) is selected automatically. voice (PRE1).....When turning the power on next time, the Voice mode is entered and the first program number of the Preset Voices (PRE1: 001) is selected automatically. voice (GM).....When turning the power on next time, the Voice mode is entered and the first program number of the GM Voices (GM: 001) is selected automatically.
Layer 1-4 Parts (Layer 1 – 4 Parts Switch)	Determines whether or not the Part 1 – 4 voices of the selected Multi are sounded simultaneously as a single Part. If this parameter is set to "on," the receive channels of the Parts 1 – 4 will automatically be set to the same value as the Receive Ch (Basic Receive Channel) parameter in the Utility Voice MIDI display of the Voice Mode. For details on the procedure, refer to the Quick Guide on page 40. Settings: off, on NOTE If this parameter is set to "on," the actual "Receive Ch" settings of the Part 1 – 4 will not be updated from the last settings.

IEEE1394 Driver	When an optional mLAN16E2 has been installed, this selects the driver for operating the mLAN16E2. On the AI Driver, set this parameter to "mLAN." For details about this parameter setting, refer to the information about the IEEE1394 Firmware contained in the MOTIF-RACK XS page at the following web site: http://www.yamahasyth.com/download/ To enable the changed setting, you will need to restart the MOTIF-RACK XS after storing the Utility settings.
Knob Disp Time (Knob Display Time)	Determines whether turning one of the Knobs 1 – 5 will cause the Knob popup window (page 29) to appear. Settings: off, 1 sec, 1.5 sec, 2 sec, 3 sec, 4 sec, 5 sec, keep offThe popup window appears only when the Knob is pressed. 1 sec – 5 secPressing or turning the Knob will cause the popup window to appear for 1 – 5 seconds, and then the window will automatically be closed. keepPressing or turning the Knob will cause the popup window to appear. When the popup window is open, calling up a different display/dialog/popup window or pressing the Knob/ [ENTER] button/ [EXIT] button will cause it to close.
Knob Sel Disp Sw (Knob Select Display Switch)	Determines whether pressing the [SELECT] button will cause the Knob Select popup window (page 29) to appear. Unlike with the Knob popup window (page 29), it is not possible to set the time to display the window. Settings: off, on
Audition Button (Audition Button Function)	Changes the function of the [AUDITION] button. When this parameter is set to "audition sw," pressing the [AUDITION] button turns Audition playback on or off. When this parameter is set to "arpeggio sw," pressing the [AUDITION] button turns Arpeggio playback on or off. When set to "arpeggio sw," the [AUDITION] button functions in the same manner as the "Arp Sw" of the Arp Select display (page 66) in Voice Common Edit or the Arpeggio display (page 91) in Multi Common Edit. Settings: audition sw, arpeggio sw
Bank/Part Wrap (Bank/Part Wrap Around)	When using the cursor [<]/[>] buttons to change the Bank/Part of the Voice/Multi mode, this determines whether pressing the cursor [>] button alternately moves continuously and changes from the last Bank/Part to the first Bank/Part and vice versa (last to first). When this parameter is set to "on," continuous change is available. Settings: off, on
LCD Contrast	Sets the LCD for optimum legibility. Settings: 1 – 16 NOTE To do this, simultaneously hold down the [UTILITY] button and turn the Encoder knob.
L&R Gain	Determines the output gain of the OUTPUT L/MONO and R jacks. Settings: +0dB, +6dB
Assign L&R Gain	Determines the output gain of the ASSIGNABLE OUT L and R jacks. Settings: +0dB, +6dB
mLAN Gain	Determines the output gain of the mLAN terminal. Settings: +0dB, +6dB
② MIDI	
MIDI In/Out	Determines which physical output/input terminal(s) will be used for transmitting/receiving MIDI data. Settings: MIDI, USB, mLAN (when the optional mLAN16E2 has been installed to the MOTIF-RACK XS) NOTE When a USB cable is not connected to the MOTIF-RACK XS, the MIDI terminal will be automatically used for transmitting/receiving MIDI data, even if this parameter is set to "USB."
MIDI Sync	Determines whether Arpeggio playback will be synchronized to the instrument's internal clock or an external MIDI clock. Settings: internal, external, auto internal.....Synchronization to internal clock. You can use this setting when this tone generator is to be used alone or as the master clock source for other equipment. external.....Synchronization to a MIDI clock received from an external MIDI instrument via MIDI. You can use this setting when the external device is to be used as master. autoWhen MIDI clock is transmitted continuously from an external MIDI device or computer, the internal clock of the MOTIF-RACK XS is not effective and the MOTIF-RACK XS is synchronized with the external clock. This setting is useful when you wish to alternate between external clock and internal clock. NOTE When setting the MOTIF-RACK XS so that Arpeggio playback is synchronized to an external MIDI clock, make sure to set the devices so that the MIDI clock from the DAW software/ external MIDI device is properly transmitted to the MOTIF-RACK XS from the DAW software/ external MIDI devices. For details on this setting, refer to page 21.
Clock Out	Determines whether MIDI clock (F8H) messages will be transmitted via MIDI. Settings: off, on NOTE When "MIDI Sync" is set to "external," MIDI clock of the MOTIF-RACK XS is not transmitted.

<p>Local Control</p>	<p>This determines whether or not the tone generator of the instrument responds to turning Knobs 1 – 5. If you set "Local Control" to "off," the Knobs are internally disconnected from the tone generator. Even if this is set to "off," the data will be transmitted via MIDI. Also, the internal tone generator will respond to messages received via MIDI.</p> <p>Settings: off (disconnect), on (connect)</p>
<p>Device No. (Device Number)</p>	<p>Determines the MIDI Device Number. This number must match the Device Number of the DAW software or the external MIDI device when transmitting/receiving Bulk Dump data, parameter changes or other System Exclusive messages.</p> <p>Settings: 1 – 16, all, off</p> <p>all When this is selected, System Exclusive messages for all MIDI device numbers are received. When System Exclusive messages such as Bulk Dump are transmitted from the MOTIF-RACK XS with this setting, the MOTIF-RACK XS is recognized as Device Number 1.</p> <p>off When this is selected, System Exclusive messages such as Bulk Dump and parameter change cannot be transmitted or received. When you try executing transmission or reception of System Exclusive messages, an error message appears.</p>
<p>Bank Select Sw (Bank Select Switch)</p>	<p>Determines whether or not Bank Select messages are transmitted or received. When this is set to "on," this tone generator responds to incoming Bank Select messages, and it also transmits appropriate Bank Select messages (when using the panel). When this is set to "off," Bank Select messages cannot be transmitted/received.</p> <p>Settings: off, on</p>
<p>Prg Change Sw (Program Change Switch)</p>	<p>Determines whether or not Program Change messages are transmitted or received. When this is set to "on," this tone generator responds to incoming Program Change messages, and it also transmits appropriate Program Change messages (when using the panel). When this is set to "off," Program Change messages cannot be transmitted/ received.</p> <p>Settings: off, on</p>
<p>Receive Bulk</p>	<p>Determines whether or not Bulk Dump data from the DAW software or the external MIDI devices can be received.</p> <p>Settings: protect (not received), on (received)</p>
<p>Controller Reset</p>	<p>Determines the status of the controllers (Modulation Wheel, Aftertouch, Foot Controller, Breath Controller, Knobs, etc.) when switching between voices. When this is set to "hold," the controllers are kept at the current setting. When this is set to "reset," the controllers are reset to the default states (below).</p> <p>Settings: hold, reset</p> <p>If you select "reset," the controllers will be reset to the following states/positions: Pitch Bend: Center; Modulation Wheel: Minimum; Aftertouch: Minimum; Foot Controller: Maximum; Foot switch: Off; Ribbon Controller: Center; Breath Controller: Maximum; Assignable Function: Off; Expression: Maximum; Sustain: Off</p>
<p>Bulk Interval</p>	<p>Determines the interval time of the Bulk Dump transmission when the Bulk Dump function is used or the Bulk Dump Request is received. The Bulk Dump function lets you save the current Voice/Multi data in the Edit buffer (DRAM) and transmit as Bulk data (System Exclusive message) to the DAW software on a computer or an external MIDI instrument.</p> <p>Settings: 0, 10ms, 20ms, 30ms</p>
<p>MIDI Soft Thru (MIDI Soft Thru Switch)</p>	<p>Determines whether received MIDI data is re-transmitted (as well as via which output) when the "MIDI In/Out" is set to "MIDI." If you have not connected a USB cable to the MOTIF-RACK XS, even if "MIDI In/Out" is set to "USB," this setting will be available since the MIDI terminal will be automatically used for transmitting/receiving MIDI data.</p> <p>Settings: off, on</p> <p>NOTE If you want to re-transmit received MIDI Clock messages (F8) via the MIDI OUT (Soft Thru) jack, set this parameter to "on," and also set the Clock Out parameter (above) to "off" so that transmission of MIDI Clock messages of the MOTIF-RACK XS is disabled.</p>
<p>Quick Setup</p>	<p>When the cursor is located here, pressing the [ENTER] button or the Encoder knob calls up the Quick Setup dialog (page 101). MOTIF-RACK XS has three combinations of the following parameter settings as appropriate for basic operations: Local Control, MIDI Sync, Clock Out, Arp MIDI Out Sw. These combinations can be selected and executed at the Quick Setup dialog, letting you instantly change all settings depending on your particular application or intended use. The three combinations can be changed by setting the following parameters in this Utility MIDI window.</p>
<p>QS 1 – 3 Local Control (Quick Setup 1 – 3 Local Control) QS 1 – 3 MIDI Sync (Quick Setup 1 – 3 MIDI Sync) QS 1 – 3 Clock Out (Quick Setup 1 – 3 Clock Out) QS 1 – 3 Arp MIDI Out Sw (Quick Setup 1 – 3 Arpeggio MIDI Out Switch)</p>	<p>Changes each parameter settings of the Quick Setup 1 – 3.</p> <p>Settings: Local Control off, on MIDI Sync internal, external, auto Clock Out off, on Arp MIDI Out Sw ... all off, all on</p>

Reference
Multi
Utility
Appendix

Quick Setup dialog

This dialog allows you to execute the Quick Setup by selecting the Quick Setup Number and pressing the [ENTER] button.

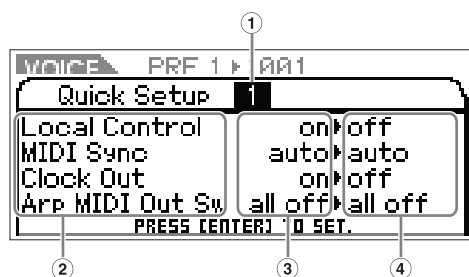

① Quick Setup Number

This parameter lets you select three types of settings registered to Quick Setup. Three types of the Initial Settings are shown below.

Settings: 1 – 3

Quick Setup Number	Application	Parameters	Other Settings
1	When recording performance data other than Arpeggio data to a DAW software on a computer.	Local control: off MIDI: auto Clock Out: off Arp MIDI Out Sw: all off	Make sure that Echo Back (MIDI Thru) on the DAW software is set to "on."
2	When recording performance data including Arpeggio data to a DAW software on a computer.	Local control: on MIDI: auto Clock Out: off Arp MIDI Out Sw: all on	Make sure that Echo Back (MIDI Thru) on the DAW software is set to "off."
3	When using the MOTIF-RACK XS as a stand-alone device, without connecting to a DAW software or other MIDI devices.	Local control: on MIDI: internal Clock Out: on Arp MIDI Out Sw: all off	—

② Quick Setup parameters (indication only)

Displays the parameters for Quick Setup.

③ Current settings for each parameter (indication only)

④ New settings after executing Quick Setup for each parameter (indication only)

⑤ Controller

Determines Controller Assign settings common to the entire system of the MOTIF-RACK XS. You can assign MIDI Control Change Numbers to the knobs on the front panel and the external controllers. For example, you could use the ASSIGN 1 and 2 knobs to control effect depth for two different effects, while using the Foot Controller to control modulation. These Control Change Number assignments are known as "Controller Assignn."

RB Ctrl No. (Ribbon Control Number)	Determines the Control Change number corresponding to a Ribbon Controller on an external device connected to the MOTIF-RACK XS. Settings: off, 1 – 95
FC 1 Ctrl No. (Foot Controller 1 Control Number) FC 2 Ctrl No. (Foot Controller 2 Control Number)	Determines the Control Change number corresponding to a Foot Controller on an external device connected to the MOTIF-RACK XS. Settings: off, 1 – 95
FS Ctrl No. (Foot Switch Control Number)	Determines the Control Change number corresponding to a Foot Switch on an external device connected to the MOTIF-RACK XS. Settings: off, 1 – 95
AS 1 Ctrl No. (Assign 1 Control Number) AS 2 Ctrl No. (Assign 2 Control Number)	Determines the Control Change number corresponding to the ASSIGN1 knob and ASSIGN2 knob (when the lamp of bottom row is lit). Settings: off, 1- 95

<p>A. Func 1 Ctrl No. (Assign Function 1 Control Number)</p> <p>A. Func 2 Ctrl No. (Assign Function 2 Control Number)</p>	<p>Determines the Control Change number generated when you use an ASSIGNABLE FUNCTION [1]/ [2] button on the MOTIF-RACK XS Editor or an external device connected to the MOTIF-RACK XS.</p> <p>Settings: off, 1 – 95</p>
<p>BC Ctrl No. (Breath Controller Control Number)</p>	<p>Determines the Control Change number generated when you use a Breath Controller on an external device connected to the MOTIF-RACK XS.</p> <p>Settings: off, 1 – 95</p>
<p>Arp Sw Ctrl No. (Arpeggio Switch Control Number)</p>	<p>Determines the Control Number that controls on/off for Arpeggio playback.</p> <p>Settings: off, 1 – 95</p>
<p>Arp Hold Ctrl No. (Arpeggio Hold Control Number)</p>	<p>Determines the Control Number that controls on/off for the Arp Hold parameter in the Arp Edit display (page 66).</p> <p>Settings: off, 1 – 95</p>
<p>Arp 1 – 5 Ctrl No. (Arpeggio 1 – 5 Control Number)</p>	<p>Determines the Control Number for switching among Arpeggios 1 – 5, stored to each Voice/Multi.</p> <p>Settings: off, 1 – 95</p>
<p>Arp Assign Mode (Arpeggio Assign Mode)</p>	<p>Determines the mode for switching among Arpeggios 1 – 5, stored to each Voice/ Multi.</p> <p>Settings: inc, direct</p> <p>inc..... Each time the MOTIF-RACK XS receives a message via the selected Control Change number, Arpeggios 1 – 5 can be switched. The actual Control Change data value does not matter.</p> <p>direct You can select the Arpeggio corresponding to the value of the selected Control Change number: 0 – 25 (Arpeggio 1), 26 – 50 (Arpeggio 2), 51 – 76 (Arpeggio 3), 77 – 101 (Arpeggio 4), 102 – 127 (Arpeggio 5)</p>
<p>③ Micro Tune (User Micro Tuning)</p> <p>From this window, you can create your original Micro Tuning in the User Bank. Tuning one octave will affect the notes of all octaves from C -2 to G8.</p>	
<p>Number (Micro Tuning Number)</p>	<p>Determines 1-4Parts” to which the created Micro Tuning setting is stored.</p> <p>Settings: 1 – 8</p>
<p>Name (Micro Tuning Name)</p>	<p>Enters the desired name for the Micro Tuning. When the cursor is located here, pressing the [ENTER] button or the Encoder knob calls up the Naming dialog, where you can enter the desired name. The Micro Tuning name can contain up to 20 characters. For detailed instructions on entering characters, refer to “Voice/ Multi Name settings (Entering Characters)” in the Quick Guide (page 47).</p>
<p>C – B (C Tuning Offset – B Tuning Offset)</p>	<p>Lets you tune the individual notes in cents to create your original Micro Tuning.</p> <p>Settings: -99 cents – +0 cents – +99 cents</p>
<p>⑤ Voice MIDI</p> <p>Determines the MIDI-related parameters. This window is available only when entering Utility from the Voice mode.</p>	
<p>Receive Ch (Basic Receive Channel)</p>	<p>Determines the MIDI receive channel when the MOTIF-RACK XS is set to Voice mode.</p> <p>Settings: 1 – 16, omni, off</p> <p>omni..... When this is selected, all channel messages are received.</p> <p>NOTE In the Multi mode, each Part receives MIDI data according to its assigned MIDI receive channel. The receive channel for each Part can be set in the Voice display of the Receive Ch parameter (page 94). However, when the “Layer 1 – 4 Parts” parameter of the Utility General display (page 98) is set to “on,” the receive channels of Parts 1 – 4 in the Multi mode are automatically set to the same value as this Receive Ch (Basic Receive Channel) parameter.</p>
<p>Transmit Ch (Basic Transmit Channel)</p>	<p>Determines the MIDI channel over which the MOTIF-RACK XS sends MIDI data generated by operating Knobs 1 – 5 (to an external sequencer, tone generator, or other device). This parameter is available in the Voice mode.</p> <p>Settings: 1 – 16, off</p>
<p>Arp MIDI Out Sw (Arpeggio MIDI Output Switch)</p>	<p>Determines whether Arpeggio playback data in the Voice mode is output to the external devices as MIDI messages. When this is set to on, the data is output.</p> <p>Settings: off, on</p>
<p>Arp Transmit Ch (Arpeggio Transmit Channel)</p>	<p>Determines the MIDI transmit channel through which Arpeggio playback data will be sent to the external devices as MIDI messages. (When the Switch parameter above is set to on.)</p> <p>Settings: 1 – 16</p>
<p>⑥ Voice mLAN</p> <p>Determines various parameters of the Audio Input signal sent from the mLAN terminal in the Voice mode, such as Output jacks, Volume, Pan, and Effect depth. Keep in mind this applies only when an optional mLAN16E2 has been installed. This window is available only when entering Utility from the Voice mode. The parameters are the same as those in the mLAN In display in Multi Common Edit (page 91).</p>	
<p>⑦ Voice MEF</p> <p>Determines Master Effect parameters in the Voice mode. The settings here affect all Voices. This window is available only when entering Utility from the Voice mode.</p>	

Switch	Determines whether the Master Effect is applied to the Voice or not. When this is set to “on,” the Master Effect will be applied. Settings: off, on
Type	Selects an Effect type. For details about the Effect type, refer to the “Basic Structure” on page 59.
Preset	This lets you call up pre-programmed settings for each Effect type, designed to be used for specific applications and situations. You can change how the sound is affected by the selected pre-programmed settings. For details about the pre-programmed settings of each Effect type, refer to the separate Data List.
Effect Parameters	The Effect parameter differs depending on the currently selected Effect type. Refer to page 61 for details about the Effect parameters. Refer to the separate Data List booklet for information on the parameters for each Effect type.

8 Voice MEQ

This window lets you set Master EQ parameters in the Voice mode, allowing you to control EQ over five independent frequency bands. The settings here affect all Voices. This window is available only when entering Utility from the Voice mode. The parameters are the same as those in the MEQ display in Multi Common Edit (page 92).

9 Fctry Set (Factory Set)

You can restore this tone generator’s User memory (page 46) to the factory default settings (Factory Set). Please note that the setting of the Power On Auto Factory Set on this window will be stored automatically by executing Factory Set. For instructions on executing Factory Set, refer to the “Restoring the Initial Factory Settings” in the Quick Guide (page 48).

⚠ CAUTION

When you restore the factory default settings, the User memory data (all the User Voices, Multis, and system settings in the Utility you created) will be overwritten with the factory defaults. Make sure you are not overwriting any important data. You should back up any important data to your computer beforehand using the Bulk Dump function (page 47).

Auto Factory Set
(Power On Auto Factory Set)

When this parameter is set to “on,” turning the power on will restore the User memory to the factory default settings. If you change this setting, make sure to execute the Factory Set function to finalize the change.
Settings: off, on

⚠ CAUTION

When setting Auto Factory Set to “on” and executing Factory Set, the Factory Set function will automatically be executed each time you turn the power on. For this reason, this normally should be set to “off.”

The Controls & Connectors

Setting Up

Listening to the Sound

Connections

Using a Computer

Quick Guide

Basic Structure

Voice

Multi

Utility

Appendix

Appendix

Display Messages

Messages	Description
All data is initialized upon power-on. Continue?	Confirms whether you want to execute a specified operation or not. If you press "YES," turning the power on next time will reset all User data to the default initial settings (factory settings).
Are you sure?	Confirms whether you want to execute a specified operation or not.
Bulk data protected.	Bulk data cannot be received because of the setting in the Utility parameters. For details, see page 100.
Completed.	The specified load, save, format, or other Job has been completed.
Device number is off.	Bulk data cannot be transmitted/received since the device number is off.
Device number mismatch.	Bulk data cannot be received since the device numbers don't match.
Executing...	Never attempt to turn off the power while data is being written to internal memory. Turning the power off in this state results in loss of all user data and may cause the system to freeze.
Illegal bulk data.	An error occurred while receiving the Bulk data or Bulk Request message.
MIDI buffer full.	process the MIDI data because too much data was received at one time.
MIDI checksum error.	An error occurred when receiving bulk data.
MIDI data error.	An error occurred when receiving MIDI data. Try again.
Mixing Voice full.	The Mixing Voice cannot be stored because the number of Voices already stored has exceeded the maximum capacity.
Now executing Factory set...	Indicates that the factory-programmed settings are currently being restored.
Now receiving MIDI bulk data...	Indicates that this instrument is receiving MIDI bulk data.
Now transmitting MIDI bulk data...	Indicates that this instrument is transmitting MIDI bulk data.
Please keep power on.	The data is being written to Flash ROM. Never attempt to turn off the power while data is being written to Flash ROM. Turning the power off while this message is shown results in loss of all user data and may cause the system to freeze (due to corruption of data in the Flash ROM). This may also result in the MOTIF-RACK XS being unable to properly start up the next time the power is turned on.
The received MIDI bulk data's type is not compatible with the current mode/voice type.	This message appears when the MOTIF-RACK XS receives the bulk data for a mode different from the current mode. Set the MOTIF-RACK XS to the mode same as the one for the bulk data. (If the Bulk data is for the Voice mode, for example, set the MOTIF-RACK XS to the Voice mode.) This message appears also when the Voice type (Normal Voice or Drum Voice) of the bulk data is different from that of the currently selected Voice. Match the Voice type.
The setting is available upon next power-on after storing Utility.	This message appears when the value of the IEEE1394 Driver parameter has been changed and stored, indicating that the setting will be active when the power is turned on next time.

About MIDI

MIDI (Musical Instrument Digital Interface) is a standard which allows electronic musical instruments to communicate with each other, by sending and receiving compatible Note, Control Change, Program Change and various other types of MIDI data, or messages. This instrument can control other MIDI devices by transmitting note related data and various types of controller data. It can also be controlled by incoming MIDI messages which automatically determine the tone generator mode, select MIDI channels, voices and effects, change parameter values, and of course play the voices specified for the various Parts.

Many MIDI messages are expressed in hexadecimal or binary numbers. Hexadecimal numbers may include the letter "H" as a suffix. The letter "n" indicates a certain whole number.

MIDI channels

MIDI performance data is assigned to one of sixteen MIDI channels. Using these channels, 1 – 16, the performance data for sixteen different instrument parts can be simultaneously sent over one MIDI cable. Think of the MIDI channels as TV channels. Each TV station transmits its broadcasts over a specific channel. Your home TV set receives many different programs simultaneously from several TV stations and you select the appropriate channel to watch the desired program.

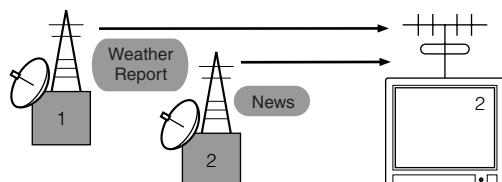

MIDI operates on the same basic principle.

The transmitting instrument sends MIDI data on a specific MIDI channel (MIDI Transmit Channel) via a single MIDI cable to the receiving instrument. If the receiving instrument's MIDI channel (MIDI Receive Channel) matches the Transmit Channel, the receiving instrument will sound according to the data sent by the transmitting instrument. For information on how to set the MIDI transmit channel and the MIDI receive channel, see page 21.

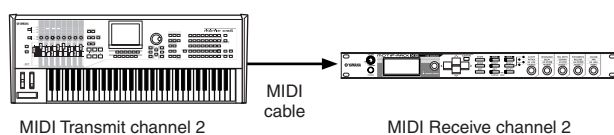

MIDI channels and MIDI ports

MIDI data is assigned to one of sixteen channels. However, we can overcome the sixteen-channel limit by using separate MIDI "ports," each supporting sixteen channels. For details, see page 18.

MIDI Messages Transmitted/Recognized

MIDI messages can be divided into two groups: Channel messages and System messages. Below is an explanation of the various types of MIDI messages which this tone generator can recognize/transmit. The messages transmitted/recognized by this instrument are shown in the MIDI Data Format and MIDI Implementation Chart of the separate Data List.

Channel Messages

Channel messages contain data related to the performance on the keyboard for the specific channel.

■ Note On/Note Off (Key On/Key Off)

Messages which are generated when the keyboard is played. Reception note range = C-2 (0) – G8 (127), C3 = 60 Velocity range = 1 – 127 (Only the Note On velocity is received)

Note On: Generated when a key is pressed.

Note Off: Generated when a key is released.

Each message includes a specific note number which corresponds to the key which is pressed, plus a velocity value based on how hard the key is struck.

■ Control Change

Control Change messages let you select a Voice bank, control volume, panning, modulation, portamento time, brightness and various other controller parameters, through specific Control Change numbers which correspond to each of the various parameters.

Bank Select MSB (Control #0)

Bank Select LSB (Control #32)

Messages which select variation Voice bank numbers by combining and sending the MSB and LSB from an external device. The functions of MSB and LSB messages differ depending on the tone generator mode. MSB numbers select Voice type (Normal Voice or Drum Voice), and LSB numbers select Voice banks. (For more information about Banks and Programs, see Voice List in the separate Data List.) A new bank selection will not become effective until the next Program Change message is received.

Modulation Wheel (Control #1)

Messages which control vibrato depth using the Modulation Wheel. Setting the value to 127 produces maximum vibrato and 0 results in vibrato off.

Portamento Time (Control #5)

Messages which control the duration of portamento, or a continuous pitch glide between successively played notes. When the parameter Portamento Switch (Control #065) is set to on, the value set here can adjust the speed of pitch change. Setting the value to 127 produces maximum portamento time and 0 results in minimum portamento time.

**Data Entry MSB (Control #6)
Data Entry LSB (Control #38)**

Messages which set the value for the parameter specified by RPN MSB/LSB. Parameter value is determined by combining the MSB and LSB.

Main Volume (Control #7)

Messages which control the volume of each Part. Setting the value to 127 produces maximum volume and 0 results in volume off.

Pan (Control #10)

Messages which control the stereo panning position of each Part (for stereo output). Setting the value to 127 positions the sound to the far right and 0 positions the sound to the far left.

Expression (Control #11)

Messages which control intonation expression of each Part during performance. Setting the value to 127 produces maximum volume and 0 results in volume off.

Hold1 (Control #64)

Messages which control sustain on/off. Setting the value between 64 – 127 turns the sustain on, between 0 – 63 turns the sustain off.

Portamento Switch (Control #65)

Messages which control portamento on/off. Setting the value between 64 -127 turns the portamento on, between 0 – 63 turns the portamento off.

Sostenuto (Control #66)

Messages which control sostenuto on/off. Holding specific notes and then pressing and holding the sostenuto pedal will sustain those notes as you play subsequent notes, until the pedal is released. Setting the value between 64 -127 turns the sostenuto on, between 0 – 63 turns the sostenuto off.

Harmonic Content (Control #71)

Messages which adjust the filter resonance set for each Part. The value set here is an offset value which will be added to or subtracted from the Voice data. Higher values will result in a more characteristic, resonant sound. Depending on the Voice, the effective range may be narrower than the range available for adjustment.

Release Time (Control #72)

Messages which adjust the AEG release time set for each Part. The value set here is an offset value which will be added to or subtracted from the Voice data.

Attack Time (Control #73)

Messages which adjust the AEG attack time set for each Part. The value set here is an offset value which will be added to or subtracted from the Voice data.

Brightness (Control #74)

Messages which adjust the filter cutoff frequency set for each Part. The value set here is an offset value which will be added to or subtracted from the Voice data. Lower values result in a softer sound. Depending on the Voice, the effective range may be narrower than the range available for adjustment.

Decay Time (Control #75)

Messages which adjust the AEG decay time set for each Part. The value set here is an offset value which will be added to or subtracted from the Voice data.

Effect1 Depth (Reverb Send Level) (Control #91)

Messages which adjust the send level for the Reverb effect.

Effect3 Depth (Chorus Send Level) (Control #93)

Messages which adjust the send level for the Chorus effect.

Data Increment (Control #96)

Data Decrement (Control #97)

Messages which increase or decrease the MSB value of pitch bend sensitivity, fine tune, or coarse tune in steps of 1. You will need to assign one of those parameters using the RPN in the external device in advance. The data byte is ignored. When the maximum value or minimum value is reached, the value will not be incremented or decremented further. (Incrementing the fine tune will not cause the coarse tune to be incremented.)

**RPN (Registered Parameter Number) LSB (Control #100)
RPN (Registered Parameter Number) MSB (Control #101)**

Messages which offset, or add or subtract values from a Part's pitch bend sensitivity, tuning, or other parameter settings. First send the RPN MSB and RPN LSB to specify the parameter which is to be controlled. Then use Data Increment/Decrement (page 94) to set the value of the specified parameter. Note that once the RPN has been set for a channel, subsequent data entry will be recognized as the same RPN's value change. Therefore after you use the RPN, you should set a Null (7FH, 7FH) value to avoid unexpected results. The following RPN numbers can be received.

RPN MSB	RPN LSB	PARAMETER
00	00	Pitch Bend Sensitivity
00	01	Fine Tune
00	02	Coarse Tune
7F	7F	Null

■ Channel Mode Messages

The following Channel Mode Messages can be received.

2nd BYTE	3rd BYTE	MESSAGE
120	0	All Sounds Off
121	0	Reset All Controllers
123	0	All Notes Off
126	0 – 16	Mono
127	0	Poly

All Sounds Off (Control #120)

Clears all sounds currently sounding on the specified channel. However, the status of channel messages such as Note On and Hold On is maintained.

Reset All Controllers (Control #121)

The values of the following controllers will be reset to the defaults.

CONTROLLER	VALUE
Pitch Bend Change	0 (center)
Aftertouch	0 (off)
Polyphonic Aftertouch	0 (off)
Modulation	0 (off)
Expression	127 (max)
Hold1	0 (off)
Portamento	0 (off)
Sostenuto	0 (off)
Soft Pedal	0 (off)
Portamento Control	Cancels the Portamento source key number
RPN	Number not specified; internal data will not change
NRPN	Number not specified; internal data will not change

All Notes Off (Control #123)

Clears all notes currently on for the specified channel. However, if Hold1 or Sostenuto is on, notes will continue sounding until these are turned off.

Mono (Control #126)

Performs the same function as when an All Sounds Off message is received, and if the 3rd byte (mono number) is in the range of 0 – 16, it sets the corresponding channel to Mono Mode (Mode 4: m = 1).

Poly (Control #127)

Performs the same function as when an All Sounds Off message is received, and sets the corresponding channel to Poly Mode.

■ Program Change

Messages that determine which Voice to select for each Part. With a combination of Bank Select, you can select not only basic Voice numbers, but also variation Voice bank numbers. For a list of the Voices, see the separate Data List.

NOTE When you specify a program change as a number in the range of 0 – 127, specify a number that is one less than the program number listed in the Voice List of the separate Data List booklet. For example, to specify program number 128, you would actually enter program change 127.

■ Pitch Bend

Pitch Bend messages are continuous controller messages that allow the pitch of designated notes to be raised or lowered by a specified amount over a specified duration.

■ Channel Aftertouch

Messages which let you control the sounds by the pressure you apply to the keys after the initial striking of the keys, over the entire channel.

■ Polyphonic Aftertouch

This message is generated when pressure is applied to a key after the note is played. Unlike the Channel Aftertouch event, however, individual data is provided for each key.

System Exclusive Messages

System messages are the data related to the overall system of the device.

■ System Exclusive Messages

System Exclusive messages control various functions of this instrument, including master volume and master tuning, tone generator mode, effect type and various other parameters.

General MIDI (GM) System On

When a “General MIDI system on” message is received, the instrument will receive MIDI messages which are compatible with GM System Level 1, and consequently will not receive Bank Select messages. When the instrument receives the GM System On, each receive channel of Parts 1 – 16 (in a Multi) will be assigned to “1 – 16.”

`F0 7E 7F 09 01 F7` (Hexadecimal)

NOTE Make sure that the interval between this message and the first note data of the song is at least a quarter note or greater in length.

MIDI Master Volume

When received, the Volume MSB will be effective for the System Parameter.

* mm (MSB) = appropriate volume value, ll (LSB) = ignored

`F0 7F 7F 04 01 11 mm F7` (Hexadecimal)

Mode Change

When received, the mode of the MOTIF-RACK XS will be switched.

* n = Device Number (page 100)

* m = 0 – 6, (0: Voice, 1 – 4: not used, 5: Multi, 6: Demo)

`F0 43 1n 7F 03 0A 00 01 0m F7` (Hexadecimal)

■ System Realtime Messages

Active Sensing (FEH)

Once FEH (Active Sensing) has been received, if no MIDI data is subsequently received for longer than an interval of approximately 300 msec, this instrument will perform the same function as when All Sounds Off, All Notes Off, and Reset All Controllers messages are received, and will then return to a status in which FEH is not monitored.

Timing Clock (F8H)

This message is transmitted with a fixed interval (24 times per quarter note) to synchronize connected MIDI instruments. You can select whether this instrument uses the internal Timing Clock, or external Timing Clock messages received via MIDI IN by setting the MIDI Sync parameter: [UTILITY] → MIDI window → “MIDI Sync.”

Installing the Optional mLAN16E2

The optionally available mLAN expansion board (mLAN16E2) can be installed to the MOTIF-RACK XS. By installing an mLAN16E2 board, you can upgrade your MOTIF-RACK XS for convenient and easy connection to an IEEE1394-compatible computer.

Installation Precautions

Before installing the optional hardware, make sure you have a Philips screwdriver and ample space to work.

⚠ WARNING

- Before beginning installation, switch off the power to the instrument and connected peripherals, and unplug them from the power outlet. Installation or removal of any devices should be started **ONLY** after the instrument (and the optional hardware) returns to normal room temperature. Then remove all cables connecting the instrument to other devices. (Leaving the power cord connected while working can result in electric shock. Leaving other cables connected can interfere with work.)
- Be careful not to drop any screws inside the instrument during installation. (This can be prevented by keeping the optional units and cover away from the instrument while attaching). If this does happen, be sure to remove the screw(s) from inside the unit before turning the power on. Loose screws inside the instrument can cause improper operation or serious damage. If you are unable to retrieve a dropped screw, consult your Yamaha dealer for advice.
- Install the optional units carefully as described in the procedure below. Improper installation can cause shorts which may result in irreparable damage and pose a fire hazard.
- Do not disassemble, modify, or apply excessive force to board areas and connectors on optional units. Bending or tampering with boards and connectors may lead to electric shock, fire, or equipment failures.

⚠ CAUTION

- It is recommended that you wear gloves to protect your hands from metallic projections on optional units and other components. Touching leads or connectors with bare hands may cause finger cuts, and may also result in poor electrical contact or electrostatic damage.
- Be careful of static electricity. Static electricity discharge can damage the IC chips on the mLAN16E2. Before you handle the optional mLAN16E2, to reduce the possibility of static electricity, touch unpainted metal parts or a ground wire on the devices that are grounded.
- Handle the optional units with care. Dropping or subjecting them to any kind of shock may cause damage or result in a malfunction.
- Do not touch the exposed metal parts in the circuit board. Touching these parts may result in a faulty contact.
- Be careful not to misplace any of the screws.
- Do not use any screws other than what are installed on the instrument. Use of incorrect screws can cause damage.

Installing the mLAN16E2

1. **Turn the power of the MOTIF-RACK XS off, and disconnect the AC power adaptor.**
Also, make sure to disconnect the MOTIF-RACK XS from any connected external devices.
2. **Remove the cover for the mLAN16E2 from the rear panel.**
With the rear panel of this tone generator facing you, remove the two screws from the cover.

IMPORTANT

Keep the removed screws in a safe place. They will be used when installing the mLAN16E2. Be careful not to misplace them. Keep the cover and fixing screws in a safe place for future use.

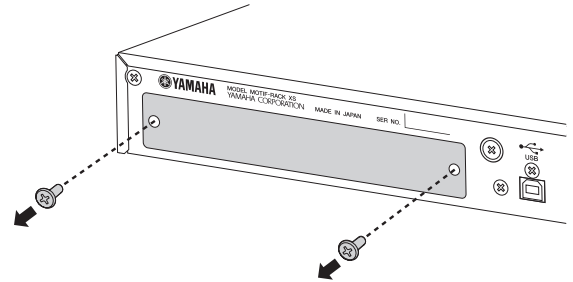

⚠ CAUTION

After removing the cover, you will see the metal fittings at the bottom of the opening. To avoid cutting or scraping your fingers, be careful not to touch them when installing the mLAN16E2.

3. Insert the mLAN16E2 along the guide rails.

Push the mLAN16E2 all the way into the slot so that the terminal at the end of the mLAN16E2 is correctly inserted into the terminal inside the slot.

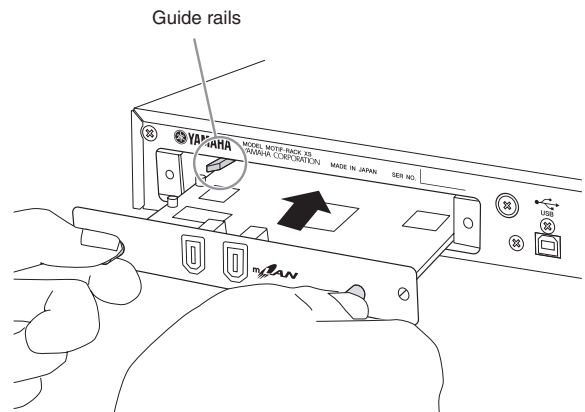

4. Replace the cover with the two screws you removed in step 2 above.

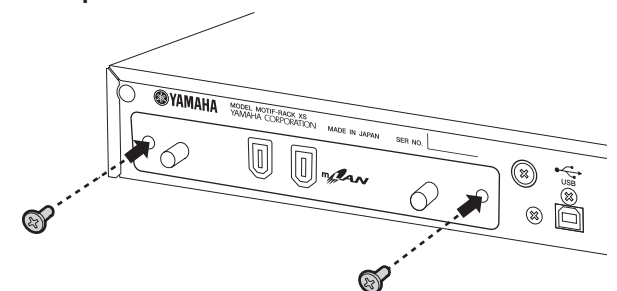

⚠ CAUTION

Malfunctions or incorrect operation may occur if the mLAN16E2 is not properly fastened.

Troubleshooting

The following table provides troubleshooting hints and page references for some common problems. Most problems may be simply the result of incorrect settings. Before contacting your Yamaha dealer or service center, refer to the troubleshooting advice below to see if you can find and correct the cause of the problem. In particular, when you have trouble getting sound out of the MOTIF-RACK XS, check the points below as you try to pinpoint the cause of the trouble.

1. Connect a set of headphones to check whether the MOTIF-RACK XS is properly producing sound. If you can hear the sound in the headphones but not from your connected audio system, you can assume that the problem is in the cable connections to the audio system.
2. If no sound can be heard through the headphones, try selecting different Voices or Multis to see whether the problem persists or not. If selecting another Voice or Multi clears up the problem, you can assume that the settings of the original Voice or Multi were at fault.

NOTE When song data settings, such as volume or expression cause a decrease in volume, selecting a different Voice or Multi will restore the volume.
3. If the problem still persists even after changing the Voice or Multi, check the master volume setting of the MOTIF-RACK XS.
4. If still no sound is output after step 3 above, the problem may be in the Utility settings of the MOTIF-RACK XS, the settings of any connected MIDI device, and/or the connecting MIDI cable.

No Sound

Volume:

- Have you made all the appropriate level settings—including the Master Volume on the MOTIF-RACK XS and the volume settings on any connected external equipment?.....pages 10 and 14

Certain settings:

- Is the volume or level setting appropriate? Check the following parameters:
 [VOICE] → [EDIT] → select "Play Mode" → [ENTER] → Volume.... page 65
 [MULTI] → [EDIT] → select any part → [ENTER] → select "Play Mode" → [ENTER] → Volume page 94
 On the MOTIF-RACK XS Editor, turn [Voice] on → select any Element or Key → select "Amplitude" → "Level"..... page 80 and 85
- On the MOTIF-RACK XS Editor, are any Elements or Parts muted? For details, refer to the manual of the MOTIF-RACK XS Editor.
- On the MOTIF-RACK XS Editor, have any of the Element Switch parameters been set to off?
 On the MOTIF-RACK XS Editor, turn [VOICE] on → turn each Element Switch/Key Switch on pages 73 and 84
- On the MOTIF-RACK XS Editor, have the Element/Drum filters been set so that they cut off almost all the sound?page 76

- Is the FEG Depth parameter set too low?
 [VOICE] → [EDIT] → select "EG" → [ENTER] → "FEG Depth" page 68
 [MULTI] → [EDIT] → select any Part → [ENTER] → select "EG" → [ENTER] → "FEG Depth" page 96
- Are the Effect settings appropriate?..... pages 33 and 38
- Are the velocity sensitivity settings set appropriately?
 [MULTI] → [EDIT] → select any Part → [ENTER] → select "Play Mode" → [ENTER] → "Vel Sens Depth" or "Vel Sens Offset" page 95
- Are the note limit and velocity limit of each Part set appropriately?
 [MULTI] → [EDIT] → select any Part → [ENTER] → select "Play Mode" → [ENTER] → "Note Limit Lo/Hi" or "Velocity Limit Lo/Hi" page 95
 On the MOTIF-RACK XS Editor, turn [VOICE] on → select any Element/Key → "Oscillator/Pitch" → "Note Limit" and "Velocity Limit" page 74
- Have the MIDI receive channels been set correctly?
 [VOICE] → [UTILITY] → select "Voice MIDI" → [ENTER] → "Receive Ch" page 102
 [MULTI] → [EDIT] → select any Part → [ENTER] → select "Voice" → [ENTER] → "Receive Ch" page 94
- Has the output of each Part been set appropriately?
 [MULTI] → [EDIT] → select any Part → select "Play Mode" [ENTER] → "Output Select" page 95
- With the Arpeggio active, has the Arpeggio Category parameter been set to "Cntr" and the Key Mode parameter set to something other than "direct"?
 [VOICE] → [EDIT] → select "Arpeggio" → [ENTER] → select "Arp Edit" → [ENTER] → "Key Mode" page 67
 [VOICE] → [EDIT] → select "Arpeggio" → [ENTER] → set the "Arp Select" to "ARP1" – "ARP5" → select "Arp 1 Type" – "Arp 5 Type" → [ENTER] → "Main Ctgr" page 68
 [MULTI] → [EDIT] → select any Part → [ENTER] → select "Arpeggio" → [ENTER] → select "Arp Edit" → [ENTER] → "Key Mode" page 67
 [MULTI] → [EDIT] → select any Part → [ENTER] → select "Arpeggio" → [ENTER] → select any of "ARP1" – "ARP5" → select "Arp 1 Type" – "Arp 5 Type" → [ENTER] → "Main Ctgr" page 68
- When the arpeggio produces no sound, are the note limit and velocity limit set appropriately?
 [VOICE] → [EDIT] → select "Arpeggio" → [ENTER] → select "Arp Edit" → [ENTER] → Note Limit Lo/Hi or Velocity Limit Lo/Hi page 67
 [MULTI] → [EDIT] → select any Part → [ENTER] → select "Arpeggio" → [ENTER] → select "Arp Edit" → [ENTER] → Note Limit Lo/Hi or Velocity Limit Lo/Hi page 96
- When the Element for which the XA Control parameter is set to "legato" in the Oscillator on the MOTIF-RACK XS Editor produces no sound, is the Mono/Poly parameter set to "mono"?
 Also, does the Element for which the XA Control parameter is set to a value other than "legato" belong to the same Element Group?..... pages 65 and 73
- When the Element for which the XA Control parameter is set to "key off sound" produces no sound, have you released the note (sending Note Off message to the tone generator) at the same time the AEG level of the same Element Group decreases?
 The Element for which the XA Control parameter is set to "key off sound" will produce sound with the AEG level of the previous Element of the same Group. Make sure to release the note at the moment the AEG level is not too low, or assign the "key off sound" Element to the different Group page 73

The Controls & Connectors

Setting Up

Listening to the Sound

Connections

Using a Computer

Quick Guide

Basic Structure

Voice

Multi

Utility

Appendix

- When the Element for which the XA Control parameter is set to “AF 1 on,” “AF 2 on” or “all AF off” on the MOTIF-RACK XS Editor does not produce any sound, have you operated the Controller to which the A.Func [1] or [2] button is assigned?.....page 101

System settings (Utility):

- Have the MIDI receive channels been set correctly?
[VOICE] → [UTILITY] → select “Voice MIDI” → [ENTER] → “Receive Ch” page 102
- Is the MIDI IN/OUT setting appropriate?
[VOICE] → [UTILITY] → select “MIDI” → [ENTER] → “MIDI In/Out” page 99

External Device or Sequencer settings:

- When playing this MOTIF-RACK XS using an external MIDI sequencer, have the transmit channels for each sequencer track and the receive channels for each Part in the Multi been set correctly?
[MULTI] → [EDIT] → select any Part → [ENTER] → select “Voice” → [ENTER] → “Receive Ch” page 94
- Are the MIDI “echo” settings (MIDI through) set appropriately?
For details, refer to the manual of your DAW software.
- When playing back a song data using an external sequencer or computer, have the volume and expression parameters been set appropriately?

External audio devices or cables:

- Has the audio equipment been connected correctly? page 13
- Are any of the MIDI cables damaged?
- Is the volume of the external device set to an appropriate level?

Distorted sound

- Are the effect settings appropriate?
Use of an effect at certain settings may produce distortion.pages 33, 38 and 57
- Are the filter settings appropriate?
Excessively high filter resonance settings can cause distortion.pages 76 and 88
- Is the MASTER VOLUME set so high that clipping is occurring?.....pages 65 and 91
Is the volume of each Element in the Voice mode or the volume of each Part in the Multi mode set too high?pages 65 and 94

Sound is very quiet.

- Has the MIDI volume or MIDI expression been set too low?
- Is the cutoff frequency of the filters set too low?pages 76 and 77

Playback continues without stopping.

- When the [AUDITION] button is turned on, press it again so that its lamp turns off.

The pitch is wrong.

- Is the tune setting appropriate?
[UTILITY] → select “General” → [ENTER] → “Tune” page 98
- Is the “Note Shift” setting appropriate?
[UTILITY] → select “General” → [ENTER] → “Note Shift” page 98
- Have the micro tuning parameters been set to an unconventional scale?
[VOICE] → [EDIT] → select “Play Mode” → [ENTER] → Micro Tune No. page 66
- Have the pitch related parameters been set appropriately? pages 74 and 85
- On the MOTIF-RACK XS Editor, has the Pitch Modulation Depth been set too high?..... page 81
- Have the following parameters been set to values other than “0”?
[MULTI] → [EDIT] → select any Part → [ENTER] → select “Play Mode” → [ENTER] → “Note Shift” or “Detune” page 94
On the MOTIF-RACK XS Editor, turn [Voice] on → select any Element/Key → “Oscillator/Pitch” → “Coarse” or “Fine” page 74
[UTILITY] → select “General” → [ENTER] → “Note Shift” page 98

Sound is choppy and intermittent.

- Are you exceeding the maximum polyphony of the instrument? page 52

Only single notes are sounded (no chords).

- Has the “Mono/Poly” parameter been set to “mono”?
[VOICE] → [EDIT] → select “Play Mode” → [ENTER] → “Mono/Poly” page 65
[MULTI] → [EDIT] → select any Part → [ENTER] → select “Play Mode” → [ENTER] → “Mono/Poly” page 95

No effects are applied.

- Have the parameters in the Effect Dialog been set appropriately? page 34
- Have any or all of the effect types been set to “thru” or “No Effect” (in the Effect display of the Voice Common Edit mode)?
On the MOTIF-RACK XS Editor, have any or all of the Elements’ Effect Output parameters been set to “thru”? page 72
- Has the Insertion Effect Switch for each Part been set to on?..... page 97

The Controls & Connectors
Setting Up
Listening to the Sound
Connections
Using a Computer
Quick Guide
Basic Structure
Voice
Multi
Utility
Appendix

Cannot call up the Play display and the dialog.

- This situation occurs when the instrument is in the Compare mode. Press the [EDIT] button to exit from the Compare mode to enable you to perform the operation.

Data communication between the computer and the MOTIF-RACK XS does not work properly.

- Check whether the Port setting on the computer is appropriate or not.pages 18 and 20
- Is the “MIDI IN/OUT” setting appropriate?
[UTILITY] → select “MIDI” → “MIDI In/Out”
If the MIDI IN/OUT terminals are used, set this parameter to “MIDI.” If the USB terminal is used, set this parameter to “USB.” If the mLAN terminal (only when the optional mLAN16E2 has been installed) is used, set this parameter to “mLAN.” page 99

Data communication between the MIDI instrument and the MOTIF-RACK XS does not work properly.

- Is the “MIDI In/Out” setting to “MIDI”?
[UTILITY] → select “MIDI” → “MIDI In/Out”=“MIDI” page 99

The MOTIF-RACK XS does not sound properly even when playing back the song data on the computer or the MIDI instrument connected to the MOTIF-RACK XS

- Is the MOTIF-RACK XS set to the Multi mode?
The Voice mode may not produce the proper sound even when playing back the Song data on the MIDI instrument or the computer connected to the MOTIF-RACK XS. Likewise, setting the “Layer 1 – 4 Parts” parameter to “on” may not produce the proper sound even when the MOTIF-RACK XS is in the Multi mode.page 98

Cannot receive bulk data.

- Is the Device Number setting correct?
If the data was saved with the Bulk Dump function of the MOTIF-RACK XS, you need to set the Device Number to the same number before Bulk Dump transmission.
[UTILITY] → select “MIDI” → [ENTER] → “Device No.” page 100
- Is the MIDI IN/OUT setting appropriate?
[UTILITY] → select “MIDI” → [ENTER] → “MIDI In/Out” page 99
- Has the Receive Bulk Switch parameter been set to “protect”?
[UTILITY] → select “MIDI” → [ENTER] → “Receive Bulk” page 100
- Are any of the MIDI cables damaged?

NOTE For information about the problems when the optional mLAN16E2 has been installed and the computer is connected to the MOTIF-RACK XS via a mLAN cable, refer to the manual of the Driver you are using.

NOTE For information on problems with use of the MOTIF-RACK XS Editor, accessory DAW software and USB-MIDI Driver, refer to the Manual or Installation Guide of the relevant software.

The Controls & Connectors
Setting Up
Listening to the Sound
Connections
Using a Computer
Quick Guide
Basic Structure
Reference
Voice
Multi
Utility
Appendix

Specifications

The Controls & Connectors	Tone Generator	Tone Generator	AWM2, with Expanded Articulation
		Polyphony	128 notes
		Wave	355MB (when converted to 16-bit linear format), 2,670 waveforms
		Voice	Preset: 1,024 Normal Voices + 64 Drum Kits GM: 128 Normal Voices + 1 Drum Kit User: 128 x 3 Normal Voices + 32 Drum Kits (Both of the User Voices are selected and copied from Preset bank)
		Multi	User: 128 Multis
Setting Up	Effects	Reverb	9 types
		Chorus	22 types
		Insertion A	53 types (up to 8 blocks available in the Multi mode)
		Insertion B	53 types (up to 8 blocks available in the Multi mode)
		Master Effect	9 types
		Master EQ	5 bands (High, High Mid, Mid, Low Mid, Low)
		Part EQ	3 bands (High, Mid, Low)
Listening to the Sound	Arpeggio	Arpeggio Type	6,633 types * MIDI Sync, MIDI transmit/receive channel, Velocity Limit, and Note Limit can be set.
		Controls	VOLUME knob, Encoder knob, Cursor buttons, AUDITION button, STORE button, ENTER button, EXIT button, VOICE button, EFFECT button, EDIT button, MULTI button, SELECT button, UTILITY button, Knobs 1 – 5
Connections	Jacks and Terminals	Front Panel	PHONES
		Rear Panel	USB TO HOST, MIDI IN/OUT, DIGITAL OUTPUT, ASSIGNABLE OUTPUT L and R, OUTPUT L/ MONO and R, DC/IN, mLAN (when the mLAN16E2 has been installed)
Using a Computer	Others	Display	160 x 64-dot graphic backlit LCD
		Supplied Accessories	AC Power adaptor (PA-301, PA-300B or an equivalent recommended by Yamaha), Owner's manual (this book), Data List, Disk x 1 (containing DAW software)
		Power Consumption	When the AC power adaptor is connected to both the MOTIF-RACK XS and the AC outlet, and the VOLUME knob is in the STANDBY position: 0.3 W When the power is turned on: 15W When the power is turned on and the optional mLAN16E2 has been installed: 20W
		Digital Output (COAXIAL)	44.1kHz, 24bit
		Dimensions	480 (W) x 379.4 (D) x 44 (H) mm
		Weight	4.2kg
		Quick Guide	
Basic Structure			

* Specifications and descriptions in this owner's manual are for information purposes only. Yamaha Corp. reserves the right to change or modify products or specifications at any time without prior notice. Since specifications, equipment or options may not be the same in every locale, please check with your Yamaha dealer.

Note on source code distribution

For three years after the final factory shipment, you may request from Yamaha the source code for any portions of the product which are licensed under the GNU General Public License by writing to the following address:

MP business unit PA•DMI Division, YAMAHA Corporation
10-1 Nakazawa-cho, Naka-ku, Hamamatsu, 430-8650, JAPAN

The source code will be provided at no charge; however, we may require you to reimburse Yamaha for the cost of delivering the source code to you.

- Note that we shall bear no responsibility whatsoever for any damage arising from changes (additions/ deletions) made to the software for this product by a third party other than Yamaha (or party authorized by Yamaha).
- Note that re-use of source code released to the public domain by Yamaha is unguaranteed, and Yamaha shall not bear any responsibility whatsoever for the source code.
- The source code can be downloaded from the following address:
<http://www.yamahasyth.com/download/source/motif-rxs>
- About GNU General Public License, refer to the separate Data List booklet.

ATTENTION**SOFTWARE LICENSE AGREEMENT**

PLEASE READ THIS SOFTWARE LICENSE AGREEMENT ("AGREEMENT") CAREFULLY BEFORE USING THIS SOFTWARE. YOU ARE ONLY PERMITTED TO USE THIS SOFTWARE PURSUANT TO THE TERMS AND CONDITIONS OF THIS AGREEMENT. THIS AGREEMENT IS BETWEEN YOU (AS AN INDIVIDUAL OR LEGAL ENTITY) AND YAMAHA CORPORATION ("YAMAHA").

BY BREAKING THE SEAL OF THIS PACKAGE YOU ARE AGREEING TO BE BOUND BY THE TERMS OF THIS LICENSE. IF YOU DO NOT AGREE WITH THE TERMS, DO NOT INSTALL, COPY, OR OTHERWISE USE THIS SOFTWARE.

THIS AGREEMENT PROVIDES YOUR USE-CONDITIONS ABOUT THE "DAW" SOFTWARE OF STEINBERG MEDIA TECHNOLOGIES GMBH("STEINBERG") WHICH IS BUNDLED WITH THIS PRODUCT. SINCE THE END-USER SOFTWARE LICENSE AGREEMENT (EUSLA) SHOWN ON YOUR PC-DISPLAY IN YOUR INSTALLING THE "DAW" SOFTWARE IS REPLACED BY THIS AGREEMENT, YOU SHOULD DISREGARD THE EUSLA. THAT IS, IN THE INSTALLING PROCESS, YOU SHOULD SELECT "AGREE" WITH THE EUSLA, WITHOUT YOUR JUDGMENT THERETO, SO AS TO PROCEED TO THE NEXT PAGE.

1. GRANT OF LICENSE AND COPYRIGHT

Yamaha hereby grants you the right to use one copy of the software program(s) and data ("SOFTWARE") accompanying this Agreement. The term SOFTWARE shall encompass any updates to the accompanying software and data. The SOFTWARE is owned by STEINBERG, and is protected by relevant copyright laws and all applicable treaty provisions. Yamaha has acquired the sublicense right to license you to use the SOFTWARE. While you are entitled to claim ownership of the data created with the use of SOFTWARE, the SOFTWARE will continue to be protected under relevant copyrights.

- **You may** use the SOFTWARE on a **single computer**.
- **You may** make one copy of the SOFTWARE in machine-readable form for backup purposes only, if the SOFTWARE is on media where such backup copy is permitted. On the backup copy, you must reproduce Amah's copyright notice and any other proprietary legends that were on the original copy of the SOFTWARE.
- **You may** permanently transfer to a third party all your rights in the SOFTWARE only when you transfer this product together, provided that you do not retain any copies and the recipient reads and agrees to the terms of this Agreement.

2. RESTRICTIONS

- **You may not** engage in reverse engineering, disassembly, decompilation or otherwise deriving a source code form of the SOFTWARE by any method whatsoever.
- **You may not** reproduce, modify, change, rent, lease, or distribute the SOFTWARE in whole or in part, or create derivative works of the SOFTWARE.
- **You may not** electronically transmit the SOFTWARE from one computer to another or share the SOFTWARE in a network with other computers.
- **You may not** use the SOFTWARE to distribute illegal data or data that violates public policy.
- **You may not** initiate services based on the use of the SOFTWARE without permission by Yamaha Corporation.
- Copyrighted data, including but not limited to MIDI data for songs, obtained by means of the SOFTWARE, are subject to the following restrictions which you must observe.
- Data received by means of the SOFTWARE may not be used for any commercial purposes without permission of the copyright owner.
- Data received by means of the SOFTWARE may not be duplicated, transferred, or distributed, or played back or performed for listeners in public without permission of the copyright owner.
- The encryption of data received by means of the SOFTWARE may not be removed nor may the electronic watermark be modified without permission of the copyright owner.

3. TERMINATION

This Agreement becomes effective on the day that you receive the SOFTWARE and remains effective until terminated. If any copyright law or provisions of this Agreement is violated, the Agreement shall terminate automatically and immediately without notice from Yamaha. Upon such termination, you must immediately destroy the licensed SOFTWARE, any accompanying written documents and all copies thereof.

4. LIMITED WARRANTY ON MEDIA

As to SOFTWARE sold on tangible media, Yamaha warrants that the tangible media on which the SOFTWARE is recorded will be free from defects in materials and workmanship under normal use for a period of fourteen (14) days from the date of receipt, as evidenced by a copy of the receipt. Amah's entire liability and your exclusive remedy will be replacement of the defective media if it is returned to Yamaha or an authorized Yamaha dealer within fourteen days with a copy of the receipt. Yamaha is not responsible for replacing media damaged by accident, abuse or misapplication. TO THE FULLEST EXTENT PERMITTED BY LAW, YAMAHA EXPRESSLY DISCLAIMS ANY IMPLIED WARRANTIES ON THE TANGIBLE MEDIA, INCLUDING THE IMPLIED WARRANTIES OF MERCHANTABILITY AND FITNESS FOR A PARTICULAR PURPOSE.

5. DISCLAIMER OF WARRANTY ON SOFTWARE

You expressly acknowledge and agree that use of the SOFTWARE is at your sole risk. The SOFTWARE and related documentation are provided "AS IS" and without warranty of any kind. NOTWITHSTANDING ANY OTHER PROVISION OF THIS AGREEMENT, YAMAHA EXPRESSLY DISCLAIMS ALL WARRANTIES AS TO THE SOFTWARE, EXPRESS, AND IMPLIED, INCLUDING BUT NOT LIMITED TO THE IMPLIED WARRANTIES OF MERCHANTABILITY, FITNESS FOR A PARTICULAR PURPOSE AND NON-INFRINGEMENT OF THIRD PARTY RIGHTS. SPECIFICALLY, BUT WITHOUT LIMITING THE FOREGOING, YAMAHA DOES NOT WARRANT THAT THE SOFTWARE WILL MEET YOUR REQUIREMENTS, THAT THE OPERATION OF THE SOFTWARE WILL BE UNINTERRUPTED OR ERROR-FREE, OR THAT DEFECTS IN THE SOFTWARE WILL BE CORRECTED.

6. LIMITATION OF LIABILITY

YAMAHA'S ENTIRE OBLIGATION HEREUNDER SHALL BE TO PERMIT USE OF THE SOFTWARE UNDER THE TERMS HEREOF. IN NO EVENT SHALL YAMAHA BE LIABLE TO YOU OR ANY OTHER PERSON FOR ANY DAMAGES, INCLUDING, WITHOUT LIMITATION, ANY DIRECT, INDIRECT, INCIDENTAL OR CONSEQUENTIAL DAMAGES, EXPENSES, LOST PROFITS, LOST DATA OR OTHER DAMAGES ARISING OUT OF THE USE, MISUSE OR INABILITY TO USE THE SOFTWARE, EVEN IF YAMAHA OR AN AUTHORIZED DEALER HAS BEEN ADVISED OF THE POSSIBILITY OF SUCH DAMAGES. In no event shall Amah's total liability to you for all damages, losses and causes of action (whether in contract, tort or otherwise) exceed the amount paid for the SOFTWARE.

7. GENERAL

This Agreement shall be interpreted according to and governed by Japanese law without reference to principles of conflict of laws. Any dispute or procedure shall be heard before the Tokyo District Court in Japan. If for any reason a court of competent jurisdiction finds any portion of this Agreement to be unenforceable, the remainder of this Agreement shall continue in full force and effect.

8. COMPLETE AGREEMENT

This Agreement constitutes the entire agreement between the parties with respect to use of the SOFTWARE and any accompanying written materials and supersedes all prior or contemporaneous understandings or agreements, written or oral, regarding the subject matter of this Agreement. No amendment or revision of this Agreement will be binding unless in writing and signed by a fully authorized representative of Yamaha.

Index

Numerics

1/4 Shift	87
1/4 tone	87
1/8 tone	87
3 Band EQ	71, 83

A

A Mod (Amplitude Modulation)	81
A. Func 1 Ctrl No. (Assign Function 1 Control Number)	102
A. Func 2 Ctrl No. (Assign Function 2 Control Number)	102
Accent Phrase	55
Accont Strt Qtz (Accent Start Quantize)	68
Accont Vel Th (Accent Velocity Threshold)	68
Active Sensing (FEH)	107
AEG (Amplitude EG)	80, 86
AEG Attack	69, 96
AEG Decay	69, 96
AEG Release	69, 96
AEG Sustain	69, 96
AI Driver	18
All Notes Off (Control #123)	107
All Sounds Off (Control #120)	106
Alternate Group	84
Alternate Pan	79, 85
AMP Level/Pan	78, 85
AMP Scale (Amplitude Scale)	81
Amplitude	52
Amplitude Scaling setting example	90
Arabic 1/2/3	87
Arp 1 – 5 Ctrl No. (Arpeggio 1 – 5 Control Number)	102
Arp 1 – 5 Select (Arpeggio 1 – 5 Select)	91
Arp 1 – 5 Type (Arpeggio 1 – 5 Type)	68, 96
Arp Assign Mode (Arpeggio Assign Mode)	102
Arp Common Sw (Arpeggio Common Switch)	91
Arp Edit (Arpeggio Edit)	66, 96
Arp Hold (Arpeggio Hold)	66
Arp Hold Ctrl No. (Arpeggio Hold Control Number)	102
Arp MIDI Out Sw (Arpeggio MIDI Output Switch)	96, 102
Arp Select (Arpeggio Select)	66, 83, 96
Arp Sw (Arpeggio Switch)	66
Arp Sw Ctrl No. (Arpeggio Switch Control Number)	102
Arp Tempo (Arpeggio Tempo)	66, 91
Arp Transmit Ch (Arpeggio Transmit Channel)	96, 102
Arpeggio	40, 91
Category	53
Sub Category	53
Type Name	54
Arpeggio Block	53
Arpeggio tempo	43, 55
Arpeggio Type	
Drum Voice	55
Non-note event	56
Normal Voice	55
Arpeggio Type List	8, 54
AS 1 Ctrl No. (Assign 1 Control Number)	101
AS 2 Ctrl No. (Assign 2 Control Number)	101
ASSIGN 1 (Assign 1 value)	30
Assign 1 Value	71, 93
ASSIGN 2 (Assign 2 value)	30
Assign 2 Value	71, 93

Assign L&R Gain	99
Assign Mode	84
ASSIGNABLE OUTPUT L and R jacks	12
ATTACK (AEG Attack Time)	30
Attack Time (Control #73)	106
Audio Channel	20
Audio Input Block	53
[AUDITION] button	10
Audition Button (Audition Button Function)	99
Audition No. (Audition Phrase Number)	66
Audition Note Shift (Audition Phrase Note Shift)	66
Audition Phrase	16
Audition Vel Shift (Audition Phrase Velocity Shift)	66
Auto Factory Set (Power On Auto Factory Set)	103
AWM2 (Advanced Wave Memory 2)	49

B

Bank	94
Bank Select LSB (Control #32)	105
Bank Select MSB (Control #0)	105
Bank Select Sw (Bank Select Switch)	100
Bank/Part Wrap (Bank/Part Wrap Around)	99
BC Ctrl No. (Breath Controller Control Number)	102
BEF (Band Elimination Filter)	89
BPF (Band Pass Filter)	88
Break Point 1 – 4	78, 81
Brightness (Control #74)	106
Bulk Dump	47
Bulk Interval	100

C

C – B (C Tuning Offset – B Tuning Offset)	102
Cable Clip	12, 13
Category	72, 73, 84, 93
Category Search	28
Center Key (Cutoff Key Follow Center Key / HPF Key Follow Center Key)	76
Change Timing	67
Channel Aftertouch	107
Channel Messages	105
Channel Mode Messages	106
Character list	47
Chorus	57, 59, 72, 93
CHORUS (Chorus Send)	30
Chorus Ins Send (Insertion Chorus Send)	84
Chorus Pan	72, 93
Chorus Return	72, 93
Chorus Send	72, 97
Chorus Send (Key Chorus Send)	83, 84, 92
Chorus To Reverb	72, 93
Clock	21, 43
Clock Out	99
Coarse (Coarse Tuning)	74, 85
Combination Type Filter	89
Common Edit	31, 36, 64, 83, 91
Common EQ	57
Compare Function	31
Compressor	60
Control	71, 83, 93
Control Change	42, 45, 101, 105
Control numbers	45
Controller	101

Controller Block	57
Controller Reset	100
Controller Set	44
Controller Set 1 – 6 Element Sw	71
Ctrl Set 1 – 6 Depth (Controller Set 1 – 6 Depth)	71
Ctrl Set 1 – 6 Dest (Controller Set 1 – 6 Destination)	71
Ctrl Set 1 – 6 Src (Controller Set 1 – 6 Source)	71
Cursor [Λ] / [V] / [←] / [→] buttons	10
CUTOFF	30
Cutoff	68, 76, 85, 96
Cutoff Key Follow (Cutoff Key Follow Sensitivity)	77
Cutoff Offset 1 – 4	78
Cutoff Velocity Sens (Cutoff Velocity Sensitivity)	76, 85

D

Data Decrement (Control #97)	106
Data Entry LSB (Control #38)	106
Data Entry MSB (Control #6)	106
Data Increment (Control #96)	106
Data List	8
DAW (digital audio workstation)	22
DC IN terminal	12, 13
DECAY (AEG Decay Time)	30
Decay Time (Control #75)	106
Delay	59, 81
Delay Time	70
Demo Song	15
Destination	45
Setting examples	88
Detune	94
Device No. (Device Number)	100
DIGITAL OUTPUT terminal	12
Distance	76
Distortion	60
DRAM	48
Drum Key	51
Drum Voice	27, 50, 52
Drum Voice Edit	31, 83
Dry Level	92, 97
Dual BEF	89
Dual BPF	89
Dual HPF	89
Dual LPF	89
Dual Type Filter	89

E

[E] (Edit) Indicator	31
Edit Buffer	48
[EDIT] button	11
Effect	72, 83, 93
Effect Block	57
[EFFECT] button	11
Effect Category	59
Effect connection	
Multi mode	58
Voice mode	58
Effect Parameter	61, 72, 93, 103
Effect Parameter 1 – 16	72, 93
Effect Types	59
Effect1 Depth (Reverb Send Level) (Control #91)	106

Effect3 Depth (Chorus Send Level) (Control #93).....	106	High Freq.....	71, 81	M	Main 1 Ctgry (Main Category 1)	65
EG.....	68, 83, 96	High Gain.....	71, 82		Main 2 Ctgry (Main Category 2)	65
EG Depth.....	75, 78	Hold Time	70		Main Ctgry (Main Category)	68
EG Depth Curve (EG Depth Velocity Sensitivity Curve).....	75, 78	Hold1 (Control #64)	106		Main Volume (Control #7)	106
EG Depth Vel Sens (EG Depth Velocity Sensitivity).....	75, 78	HPF (High Pass Filter)	88		Master	93
Element.....	31, 50, 51	HPF Cutoff (High Pass Filter Cutoff Frequency)	77, 85		Master Effect.....	57
Element Edit	32, 73	HPF Key Follow (High Pass Filter Cutoff Key Follow Sensitivity)	77		Master EQ	57
Element EQ.....	57				Mega Voice.....	53
Element Out 1 – 8.....	72	I			Mega Voice Arpeggio.....	53
Element Switch 1 – 8	73	IEEE1394	19		MEQ (Master EQ)	92
Elm Group (Element Group).....	73	IEEE1394 Driver.....	99		Micro Tune (User Micro Tuning).....	102
Encoder knob	10	Indian.....	87		Micro Tune Bank (Micro Tuning Bank)	66
[ENTER] button.....	10	initialize	11, 36		Micro Tune No. (Micro Tuning Number)	66
EQ.....	81, 86	Input Channel	20		Micro Tune Root (Micro Tuning Root).....	66
EQ HIGH (EQ High Gain)	30	Ins A (Insertion Effect A).....	72		Micro Tuning List	87
EQ LOW (EQ Low Gain)	30	Ins B (Insertion Effect B).....	72		Mid Freq	71
EQ MID (EQ Middle Gain)	30	Ins Effect Output (Insertion Effect Output)	84		Mid Gain	71
EQ MID F (EQ Middle Frequency)	30	Ins Effect Sw (Insertion Effect Switch)	97		Mid Q	71
EQ MID Q (EQ Middle Q)	30	Insertion Connection.....	72		MIDI	99, 105
Equal	87	Insertion Effect.....	57		MIDI channel	18, 35, 105
[EXIT] button.....	10, 26	K			MIDI In/Out	99
Expanded Articulation (XA)	51	Key.....	83, 84		MIDI IN/OUT terminal	12
Expression (Control #11).....	106	Key Assign Mode	65		MIDI Master Volume	107
Extensions for Steinberg DAW	24	Key Edit	32, 84		MIDI port.....	18, 35
External controller.....	44	Key Mode	67		MIDI Receive Channel.....	21
F		Key on Delay	73		MIDI Soft Thru (MIDI Soft Thru Switch).....	100
F Mod (Filter Modulation)	81	Key on Reset	69, 81		MIDI Sync	99
Factory Set	48, 103	Key On/Key Off.....	105		MIDI terminal	18
Fade in Time.....	70, 81	Key Out (Drum Key Out).....	83		MIDI Transmit Channel	21, 102
Fade out Time.....	70	Key Sw (Key Switch).....	84		MISC	60
Favorite Category	29	Kirnberger.....	87		mLAN (IEEE1394) terminal 1, 2	12
FC 1 Ctrl No. (Foot Controller 1 Control Number)	101	Knob Disp Time (Knob Display Time)	99		mLAN expansion board (mLAN16E2)	12, 108
FC 2 Ctrl No. (Foot Controller 2 Control Number)	101	Knob Sel Disp Sw (Knob Select Display Switch)	99		mLAN Gain	99
Fctry Set (Factory Set).....	103	Knobs 1 – 5.....	11, 29, 30, 36		mLAN In.....	91
FEG (Filter EG)	77	L			mLAN monitor (mLAN monitor switch)	98
FEG Attack	68, 96	L&R Gain	99		Mode Change	107
FEG Decay	68, 96	Layer 1-4 Parts (Layer 1 – 4 Parts Switch)	98		Modulation Wheel (Control #1)	105
FEG Depth.....	68, 96	LCD (Liquid Crystal Display).....	10		Mono (Control #126).....	107
FEG DEPTH (Filter EG Depth).....	30	LCD Contrast.....	99		Mono / Stereo	92
FEG Release.....	68, 96	legato.....	51		Mono/Poly	65, 95
Filter.....	51, 68, 83, 96	Level	75, 77, 78, 80, 85, 86		MOTIF-RACK XS Editor	23
Filter Scale.....	78	Level Key Follow	79		Multi	52
Filter Scaling setting example	90	Level Key Follow Center Key (Level Key Follow Sensitivity Center Key)	79		[MULTI] button.....	11
Filter Type.....	76, 85	Level Offset 1 – 4	81		Multi Edit	36, 91
Filter Type List	88	Level Velocity Curve (Level Velocity Sensitivity Curve).....	79		Multi Effect Edit.....	38
Fine (Fine Tuning).....	74, 85	Level Velocity Offset (Level Velocity Sensitivity Offset).....	79		Multi mode	35, 91
Fine Scaling (Fine Scaling Sensitivity).....	74	Level Velocity Sens (Level Velocity Sensitivity)	79		Multi Name.....	47
Flanger	59	LFO (Common LFO)	69	N	Name	47, 65, 73, 83, 84, 91
Flash ROM.....	48	LFO (Low Frequency Oscillator).....	52, 81		Name (Micro Tuning Name)	102
Freq (Frequency).....	92, 96	LFO Phase Offset	70		Name (Multi Name).....	91
FS Ctrl No. (Foot Switch Control Number).....	101	LFO Set 1 – 3 Depth	70		Normal Voice	27, 50, 52
Fx Send (Effect Send)	97	LFO Set 1 – 3 Depth Offset.....	70		Normal Voice Edit	31, 64
G		LFO Set 1 – 3 Dest (LFO Set 1 – 3 Destination).....	70		Note Limit.....	74
Gain	76, 93, 96	LFO Set 1 – 3 Element Sw	70		Note Limit Lo/Hi	67, 95
Gate Time Rate.....	66	LFO Wave	81		Note On/Note Off	105
General.....	98	Local Control	100		Note Shift	65, 94, 98
General MIDI (GM) System On	107	Lo-Fi.....	60		Number	73, 84, 94
GM Bank.....	27	Loop.....	67		Number (Micro Tuning Number)	102
GM Voice.....	27	Low Freq.....	71, 81	O	Octave Range.....	67
GTime Rate (Gate Time Rate Offset).....	68	Low Gain.....	71, 82		Octave Shift	67
H		LPF (Low Pass Filter)	88		OSC (Oscillator).....	73, 84
Half Damper (Half Damper Switch).....	80	LPF12+BPf6.....	89		Oscillator.....	51
Half Damper Time	80				Output Channel	20
Harmonic Content (Control #71)	106				OUTPUT L/MONO and R jacks	12, 13
					Output Select.....	85, 92, 95
					Output Select List	90

- P**
- P Mod (Pitch Modulation)81
 - PAN30
 - Pan65, 79, 85, 91, 94
 - Pan (Control #10)106
 - Param. with Voice (Parameter with Voice)94
 - Part37
 - Part Edit36, 94
 - Part EQ57, 96
 - PB Range Lower (Pitch Bend Range Lower)65, 94
 - PB Range Upper (Pitch Bend Range Upper)65, 94
 - PEG (Pitch EG)74
 - Phase69
 - Phaser59
 - PHONES jack10, 13
 - Pitch51
 - Pitch Bend107
 - Pitch Key Follow (Pitch Key Follow Sensitivity)74
 - Pitch Key Follow Center Key74
 - Play Mode65, 69, 83, 94
 - Poly (Control #127)107
 - Polyphonic Aftertouch107
 - Porta Lgt Slope (Portamento Legato Slope)66
 - Porta Mode (Portamento Mode)65, 95
 - Porta Sw (Portamento Switch)65, 95
 - Porta Time (Portamento Time)65, 95
 - Porta Time Mode (Portamento Time Mode)65
 - PORTAMENTO30
 - Portamento Switch (Control #65)106
 - Portamento Time (Control #5)106
 - Power on Mode98
 - Preset72, 93, 103
 - Preset Bank27
 - Prg Change Sw (Program Change Switch)100
 - Program Change107
 - PureMajor87
 - PureMinor87
- Q**
- Q (Bandwidth)82, 93
 - QS 1 – 3 Arp MIDI Out Sw (Quick Setup 1 – 3 Arpeggio MIDI Out Switch)100
 - QS 1 – 3 Clock Out (Quick Setup 1 – 3 Clock Out)100
 - QS 1 – 3 Local Control (Quick Setup 1 – 3 Local Control)100
 - QS 1 – 3 MIDI Sync (Quick Setup 1 – 3 MIDI Sync)100
 - Quantize Strngth (Quantize Strength)67
 - Quantize Value67
 - Quick Setup100
 - Quick Setup dialog101
- R**
- Random74
 - Random Pan79, 85
 - Random SFX55, 68
 - Random Speed69
 - RB Ctrl No. (Ribbon Control Number)101
 - Rcv Sw (Receive Switch)97
 - Receive Bulk100
 - Receive Ch (Basic Receive Channel)102
 - Receive Ch (Receive Channel)94
 - Receive Note Off84
 - RELEASE (AEG Release Time)30
 - Release Time (Control #72)106
 - Reset48
 - Reset All Controllers (Control #121)107
 - RESONANCE30
 - Resonance68, 76, 85, 96
 - Resonance Velocity Sens (Resonance Velocity Sensitivity)76
 - Reverb57, 59, 72, 93
 - REVERB (Reverb Send)30
 - Reverb Ins Send (Insertion Reverb Send)84
 - Reverb Pan72, 93
 - Reverb Return72, 93
 - Reverb Send72, 97
 - Reverb Send (Key Reverb Send)83, 84, 92
 - REV-X61
 - RPN (Registered Parameter Number)106
- S**
- Scaling Pan79
 - Segment (EG Time Velocity Sensitivity Segment)75, 78, 80
 - [SELECT] button11
 - SFX Key on Ctrl (Random SFX Key on Control)68
 - SFX Vel Offset (Random SFX Velocity Offset)68
 - Shape92
 - single timbre50
 - Sostenuto (Control #66)106
 - Source45
 - Speed69, 81
 - Store46
 - [STORE] button10
 - Store Compare46
 - Studio Connections24
 - Studio Manager V223
 - Sub 1 Ctgr (Sub Category 1)65
 - Sub 2 Ctgr (Sub Category 2)65
 - Sub Ctgr (Sub Category)68
 - SUSTAIN (AEG Sustain Level)30
 - Swing67
 - Switch72, 93, 103
 - Sync Qntz Val (Sync Quantize Value)91
 - Synchronize21
 - System Effects57
 - System Exclusive Messages107
 - System Realtime Messages107
- T**
- Tech60
 - TEMPO (Arpeggio Tempo)30
 - Tempo (Delay Tempo)73
 - Tempo Speed69
 - Tempo Sync69
 - Tempo Sync (Delay Tempo Sync)73
 - Thru Port18
 - Time74, 77, 80, 86
 - Time Key Follow (EG Time Key Follow Sensitivity)76, 78, 81
 - Time Key Follow Center Key (EG Time Key Follow Sensitivity Center Key)76, 78, 80
 - Time Vel Sens (EG Time Velocity Sensitivity)80
 - Time Velocity Sens (EG Time Velocity Sensitivity)75, 77
 - Timing Clock (F8H)107
 - Tone Generator Block50
 - Transmit Ch (Basic Transmit Channel)102
 - tremolo52
 - Tremolo & Rotary60
 - Trigger Mode68
 - Troubleshooting109
 - Tune74, 85, 98
 - Type68, 72, 76, 93, 103
 - Type (EQ Type)81
- U**
- Unit Multiply67
 - USB TO HOST terminal12, 17, 18
 - USB-MIDI driver17
 - User Bank27, 35
 - User LFO Cycle70
 - User LFO Slope70
 - User LFO Step Value 1 – 1671
 - User LFO Template71
 - User Memory48
 - Utility98
 - [UTILITY] button11
- V**
- Vallot&Yng87
 - VCM (Virtual Circuitry Modeling)61
 - Vel Cross Fade (Velocity Cross Fade)73
 - Vel Rate (Velocity Rate Offset)68
 - Vel Sens (Pitch Velocity Sensitivity)74, 85
 - Vel Sens Depth (Velocity Sensitivity Depth)95
 - Vel Sens Offset (Velocity Sensitivity Offset)95
 - Velocity Limit74
 - Velocity Limit Lo/Hi67, 95
 - Velocity Mode67
 - Velocity Rate66
 - Velocity Sens (Level Velocity Sensitivity)85
 - vibrato52
 - Voice27, 50, 94
 - [VOICE] button11
 - Voice Edit31
 - Voice Effect Edit33
 - Voice Elm Pan (Voice Element Pan)94
 - Voice MEF102
 - Voice MEQ103
 - Voice MIDI102
 - Voice mLAN102
 - Voice mode27, 50, 64
 - Voice Name47
 - Voice with Arp (Voice with Arpeggio)96
 - VOLUME30
 - Volume65, 91, 94, 98
 - [VOLUME] knob10, 14
- W**
- Wah52, 60
 - Wave69
 - Wave Bank73, 84
 - Werckmeister87
 - Width76
- X**
- XA Control (Expanded Articulation Control)73

For details of products, please contact your nearest Yamaha representative or the authorized distributor listed below.

Pour plus de détails sur les produits, veuillez-vous adresser à Yamaha ou au distributeur le plus proche de vous figurant dans la liste suivante.

Die Einzelheiten zu Produkten sind bei Ihrer unten aufgeführten Niederlassung und bei Yamaha Vertragshändlern in den jeweiligen Bestimmungsländern erhältlich.

Para detalles sobre productos, contacte su tienda Yamaha más cercana o el distribuidor autorizado que se lista debajo.

NORTH AMERICA

CANADA

Yamaha Canada Music Ltd.
135 Milner Avenue, Scarborough, Ontario,
M1S 3R1, Canada
Tel: 416-298-1311

U.S.A.

Yamaha Corporation of America
6600 Orangethorpe Ave., Buena Park, Calif. 90620,
U.S.A.
Tel: 714-522-9011

CENTRAL & SOUTH AMERICA

MEXICO

Yamaha de México S.A. de C.V.
Calz. Javier Rojo Gómez #1149,
Col. Guadalupe del Moral
C.P. 09300, México, D.F., México
Tel: 55-5804-0600

BRAZIL

Yamaha Musical do Brasil Ltda.
Rua Joaquim Floriano, 913 - 4º andar, Itaim Bibi,
CEP 04534-013 Sao Paulo, SP. BRAZIL
Tel: 011-3704-1377

ARGENTINA

Yamaha Music Latin America, S.A.
Sucursal de Argentina
Olga Cossettini 1553, Piso 4 Norte
Madero Este-C1107CEK
Buenos Aires, Argentina
Tel: 011-4119-7000

PANAMA AND OTHER LATIN AMERICAN COUNTRIES/ CARIBBEAN COUNTRIES

Yamaha Music Latin America, S.A.
Torre Banco General, Piso 7, Urbanización Marbella,
Calle 47 y Aquilino de la Guardia,
Ciudad de Panamá, Panamá
Tel: +507-269-5311

EUROPE

THE UNITED KINGDOM

Yamaha Music U.K. Ltd.
Sherbourne Drive, Tilbrook, Milton Keynes,
MK7 8BL, England
Tel: 01908-366700

IRELAND

Danfay Ltd.
61D, Sallynoggin Road, Dun Laoghaire, Co. Dublin
Tel: 01-2859177

GERMANY

Yamaha Music Central Europe GmbH
Siemensstraße 22-34, 25462 Rellingen, Germany
Tel: 04101-3030

SWITZERLAND/LIECHTENSTEIN

Yamaha Music Central Europe GmbH,
Branch Switzerland
Seefeldstrasse 94, 8008 Zürich, Switzerland
Tel: 01-383 3990

AUSTRIA

Yamaha Music Central Europe GmbH,
Branch Austria
Schleiergasse 20, A-1100 Wien, Austria
Tel: 01-60203900

CZECH REPUBLIC/SLOVAKIA/ HUNGARY/SLOVENIA

Yamaha Music Central Europe GmbH,
Branch Austria, CEE Department
Schleiergasse 20, A-1100 Wien, Austria
Tel: 01-602039025

POLAND

Yamaha Music Central Europe GmbH
Sp.z o.o. Oddział w Polsce
ul. 17 Stycznia 56, PL-02-146 Warszawa, Poland
Tel: 022-868-07-57

THE NETHERLANDS/ BELGIUM/LUXEMBOURG

Yamaha Music Central Europe GmbH,
Branch Benelux
Clarissenhof 5-b, 4133 AB Vianen, The Netherlands
Tel: 0347-358 040

FRANCE

Yamaha Musique France
BP 70-77312 Marne-la-Vallée Cedex 2, France
Tel: 01-64-61-4000

ITALY

Yamaha Musica Italia S.P.A.
Combo Division
Viale Italia 88, 20020 Lainate (Milano), Italy
Tel: 02-935-771

SPAIN/PORTUGAL

Yamaha Música Ibérica, S.A.
Ctra. de la Coruna km. 17, 200, 28230
Las Rozas (Madrid), Spain
Tel: 91-639-8888

GREECE

Philippos Nakas S.A. The Music House
147 Skiathou Street, 112-55 Athens, Greece
Tel: 01-228 2160

SWEDEN

Yamaha Scandinavia AB
J. A. Wettergrens Gata 1, Box 30053
S-400 43 Göteborg, Sweden
Tel: 031 89 34 00

DENMARK

YS Copenhagen Liaison Office
Generatorvej 6A, DK-2730 Herlev, Denmark
Tel: 44 92 49 00

FINLAND

F-Musiikki Oy
Kluuvikatu 6, P.O. Box 260,
SF-00101 Helsinki, Finland
Tel: 09 618511

NORWAY

Norsk filial av Yamaha Scandinavia AB
Grini Næringspark 1, N-1345 Østerås, Norway
Tel: 67 16 77 70

ICELAND

Skifan HF
Skeifan 17 P.O. Box 8120, IS-128 Reykjavik, Iceland
Tel: 525 5000

RUSSIA

Yamaha Music (Russia)
Office 4015, entrance 2, 21/5 Kuznetskii
Most street, Moscow, 107996, Russia
Tel: 495 626 0660

OTHER EUROPEAN COUNTRIES

Yamaha Music Central Europe GmbH
Siemensstraße 22-34, 25462 Rellingen, Germany
Tel: +49-4101-3030

AFRICA

Yamaha Corporation,
Asia-Pacific Music Marketing Group
Nakazawa-cho 10-1, Naka-ku, Hamamatsu,
Japan 430-8650
Tel: +81-53-460-2312

MIDDLE EAST

TURKEY/CYPRUS

Yamaha Music Central Europe GmbH
Siemensstraße 22-34, 25462 Rellingen, Germany
Tel: 04101-3030

OTHER COUNTRIES

Yamaha Music Gulf FZE
LOB 16-513, P.O.Box 17328, Jubel Ali,
Dubai, United Arab Emirates
Tel: +971-4-881-5868

ASIA

THE PEOPLE'S REPUBLIC OF CHINA

Yamaha Music & Electronics (China) Co.,Ltd.
25/F., United Plaza, 1468 Nanjing Road (West),
Jingan, Shanghai, China
Tel: 021-6247-2211

HONG KONG

Tom Lee Music Co., Ltd.
11/F., Silvercord Tower 1, 30 Canton Road,
Tsimshatsui, Kowloon, Hong Kong
Tel: 2737-7688

INDONESIA

PT. Yamaha Music Indonesia (Distributor)
PT. Nusantik
Gedung Yamaha Music Center, Jalan Jend. Gatot
Subroto Kav. 4, Jakarta 12930, Indonesia
Tel: 21-520-2577

KOREA

Yamaha Music Korea Ltd.
8F, 9F, Dongsung Bldg. 158-9 Samsung-Dong,
Kangnam-Gu, Seoul, Korea
Tel: 080-004-0022

MALAYSIA

Yamaha Music Malaysia, Sdn., Bhd.
Lot 8, Jalan Perbandaran, 47301 Kelana Jaya,
Petaling Jaya, Selangor, Malaysia
Tel: 3-78030900

PHILIPPINES

Yupangco Music Corporation
339 Gil J. Puyat Avenue, P.O. Box 885 MCPO,
Makati, Metro Manila, Philippines
Tel: 819-7551

SINGAPORE

Yamaha Music Asia Pte., Ltd.
#03-11 A-Z Building
140 Paya Lebor Road, Singapore 409015
Tel: 747-4374

TAIWAN

Yamaha KHS Music Co., Ltd.
3F, #6, Sec.2, Nan Jing E. Rd. Taipei.
Taiwan 104, R.O.C.
Tel: 02-2511-8688

THAILAND

Siam Music Yamaha Co., Ltd.
4, 6, 15 and 16th floor, Siam Motors Building,
891/1 Rama 1 Road, Wangmai,
Pathumwan, Bangkok 10330, Thailand
Tel: 02-215-2626

OTHER ASIAN COUNTRIES

Yamaha Corporation,
Asia-Pacific Music Marketing Group
Nakazawa-cho 10-1, Naka-ku, Hamamatsu,
Japan 430-8650
Tel: +81-53-460-2317

OCEANIA

AUSTRALIA

Yamaha Music Australia Pty. Ltd.
Level 1, 99 Queensbridge Street, Southbank,
Victoria 3006, Australia
Tel: 3-9693-5111

NEW ZEALAND

Music Works LTD
P.O.BOX 6246 Wellesley, Auckland 4680,
New Zealand
Tel: 9-634-0099

COUNTRIES AND TRUST TERRITORIES IN PACIFIC OCEAN

Yamaha Corporation,
Asia-Pacific Music Marketing Group
Nakazawa-cho 10-1, Naka-ku, Hamamatsu,
Japan 430-8650
Tel: +81-53-460-2312



Yamaha Web Site (English only)
<http://www.yamahasyth.com/>
Yamaha Manual Library
<http://www.yamaha.co.jp/manual/>

U.R.G., Pro Audio & Digital Musical Instrument Division, Yamaha Corporation
© 2008 Yamaha Corporation

WM96450 805MWDH67.2-02B0
Printed in Japan