

# ARIUS

## YDP-V240

### Owner's Manual Bedienungsanleitung Mode d'emploi Manual de instrucciones

For information on assembling the keyboard stand, refer to the instructions at the end of this manual.

**IMPORTANT — Check your power supply —**

Make sure that your local AC mains voltage matches the voltage specified on the name plate on the bottom panel. In some areas a voltage selector may be provided on the bottom panel of the main keyboard unit near the power cord. Make sure that the voltage selector is set for the voltage in your area. The voltage selector is set at 240V when the unit is initially shipped.

To change the setting use a "minus" screwdriver to rotate the selector dial so that the correct voltage appears next to the pointer on the panel.

Weitere Informationen über die Montage des Keyboard-Ständers erhalten Sie in den Anweisungen am Ende dieses Handbuchs.

**WICHTIG — Überprüfen Sie Ihren Netzanschluss —**

Vergewissern Sie sich, dass die Spannung in Ihrem örtlichen Stromnetz mit der Spannung übereinstimmt, die auf dem Typenschild auf der Unterseite des Instruments angegeben ist. In bestimmten Regionen ist auf der Unterseite des Keyboards in der Nähe des Netzkabels ein Spannungswähler angebracht. Vergewissern Sie sich, dass der Spannungswähler auf die Spannung Ihres lokalen Stromnetzes eingestellt ist. Dieser Spannungswähler ist bei Auslieferung auf 240 V eingestellt. Sie können die Einstellung mit einem Schlitzschraubenzieher ändern. Drehen Sie dazu den Wählschalter, bis der Pfeil auf dem Instrument auf die richtige Spannung zeigt.

Pour obtenir des informations sur l'assemblage du support du clavier, reportez-vous aux instructions à la fin de ce manuel.

**IMPORTANT — Contrôler la source d'alimentation —**

Vérifiez que la tension spécifiée sur le panneau inférieur correspond à la tension du secteur. Dans certaines régions, l'instrument peut être équipé d'un sélecteur de tension situé sur le panneau inférieur du clavier à proximité du cordon d'alimentation. Vérifiez que ce sélecteur est bien réglé en fonction de la tension secteur de votre région. Le sélecteur de tension est réglé sur 240 V au départ d'usine. Pour modifier ce réglage, utilisez un tournevis à lame plate pour tourner le sélecteur afin de mettre l'indication correspondant à la tension de votre région vis à vis du repère triangulaire situé sur le panneau.

Para información sobre el montaje del soporte del teclado, consulte las instrucciones al final de este manual.

**IMPORTANTE — Verifique la alimentación de corriente —**

Asegúrese de que tensión de alimentación de CA de su área corresponde con la tensión especificada en la placa de características del panel inferior. En algunas zonas puede haberse incorporado un selector de tensión en el panel inferior de la unidad del teclado principal, cerca del cable de alimentación. Asegúrese de que el selector de tensión esté ajustado a la tensión de su área. El selector de tensión se ajusta a 240V cuando la unidad sale de fábrica. Para cambiar el ajuste, emplee un destornillador de cabeza "recta" para girar el selector de modo que aparezca la tensión correcta al lado del indicador del panel.

English

Deutsch

Français

Español

EN  
DE  
FR  
ES



# SPECIAL MESSAGE SECTION

**PRODUCT SAFETY MARKINGS:** Yamaha electronic products may have either labels similar to the graphics shown below or molded/stamped facsimiles of these graphics on the enclosure. The explanation of these graphics appears on this page. Please observe all cautions indicated on this page and those indicated in the safety instruction section.

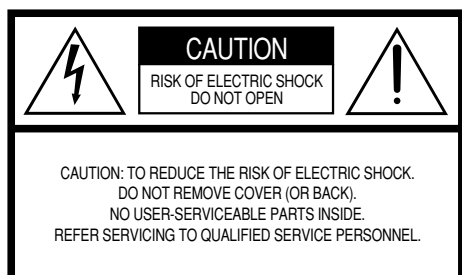

See bottom of Keyboard enclosure for graphic symbol markings.



The exclamation point within the equilateral triangle is intended to alert the user to the presence of important operating and maintenance (servicing) instructions in the literature accompanying the product.



The lightning flash with arrowhead symbol, within the equilateral triangle, is intended to alert the user to the presence of uninsulated “dangerous voltage” within the product’s enclosure that may be of sufficient magnitude to constitute a risk of electrical shock.

**IMPORTANT NOTICE:** All Yamaha electronic products are tested and approved by an independent safety testing laboratory in order that you may be sure that when it is properly installed and used in its normal and customary manner, all foreseeable risks have been eliminated. **DO NOT** modify this unit or commission others to do so unless specifically authorized by Yamaha. Product performance and/or safety standards may be diminished. Claims filed under the expressed warranty may be denied if the unit is/has been modified. Implied warranties may also be affected.

**SPECIFICATIONS SUBJECT TO CHANGE:** The information contained in this manual is believed to be correct at the time of printing. However, Yamaha reserves the right to change or modify any of the specifications without notice or obligation to update existing units.

**ENVIRONMENTAL ISSUES:** Yamaha strives to produce products that are both user safe and environmentally friendly. We sincerely believe that our products and the production methods used to produce them, meet these goals. In keeping with both the letter and the spirit of the law, we want you to be aware of the following:

**Battery Notice:** This product MAY contain a small non-rechargeable battery which (if applicable) is soldered in place. The average life span of this type of battery is approximately five years. When replacement becomes necessary, contact a qualified service representative to perform the replacement.

**Warning:** Do not attempt to recharge, disassemble, or incinerate this type of battery. Keep all batteries away from children. Dispose of used batteries promptly and as regulated by applicable laws. Note: In some areas, the servicer is required by law to return the defective parts. However, you do have the option of having the servicer dispose of these parts for you.

**Disposal Notice:** Should this product become damaged beyond repair, or for some reason its useful life is considered to be at an end, please observe all local, state, and federal regulations that relate to the disposal of products that contain lead, batteries, plastics, etc.

**NOTICE:** Service charges incurred due to lack of knowledge relating to how a function or effect works (when the unit is operating as designed) are not covered by the manufacturer’s warranty, and are therefore the owners responsibility. Please study this manual carefully and consult your dealer before requesting service.

**NAME PLATE LOCATION:** The graphic below indicates the location of the name plate. The model number, serial number, power requirements, etc., are located on this plate. You should record the model number, serial number, and the date of purchase in the spaces provided below and retain this manual as a permanent record of your purchase.

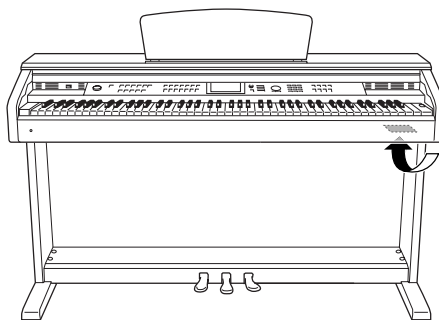

**Model** \_\_\_\_\_

**Serial No.** \_\_\_\_\_

**Purchase Date** \_\_\_\_\_

# FCC INFORMATION (U.S.A.)

## 1. IMPORTANT NOTICE: DO NOT MODIFY THIS UNIT!

This product, when installed as indicated in the instructions contained in this manual, meets FCC requirements. Modifications not expressly approved by Yamaha may void your authority, granted by the FCC, to use the product.

## 2. IMPORTANT:

When connecting this product to accessories and/or another product use only high quality shielded cables. Cable/s supplied with this product MUST be used. Follow all installation instructions. Failure to follow instructions could void your FCC authorization to use this product in the USA.

## 3. NOTE:

This product has been tested and found to comply with the requirements listed in FCC Regulations, Part 15 for Class "B" digital devices. Compliance with these requirements provides a reasonable level of assurance that your use of this product in a residential environment will not result in harmful interference with other electronic devices. This equipment generates/uses radio frequencies and, if not installed and used according to the instructions found in the users manual, may cause interference harmful to the operation of other electronic devices. Compliance with FCC regulations does

not guarantee that interference will not occur in all installations. If this product is found to be the source of interference, which can be determined by turning the unit "OFF" and "ON", please try to eliminate the problem by using one of the following measures:

Relocate either this product or the device that is being affected by the interference.

Utilize power outlets that are on different branch (circuit breaker or fuse) circuits or install AC line filter/s.

In the case of radio or TV interference, relocate/reorient the antenna. If the antenna lead-in is 300 ohm ribbon lead, change the lead-in to co-axial type cable.

If these corrective measures do not produce satisfactory results, please contact the local retailer authorized to distribute this type of product. If you can not locate the appropriate retailer, please contact Yamaha Corporation of America, Electronic Service Division, 6600 Orangethorpe Ave, Buena Park, CA90620

The above statements apply ONLY to those products distributed by Yamaha Corporation of America or its subsidiaries.

\* This applies only to products distributed by YAMAHA CORPORATION OF AMERICA.

(class B)

## IMPORTANT NOTICE FOR THE UNITED KINGDOM Connecting the Plug and Cord

IMPORTANT. The wires in this mains lead are coloured in accordance with the following code:

BLUE : NEUTRAL  
BROWN : LIVE

As the colours of the wires in the mains lead of this apparatus may not correspond with the coloured markings identifying the terminals in your plug proceed as follows:

The wire which is coloured BLUE must be connected to the terminal which is marked with the letter N or coloured BLACK.

The wire which is coloured BROWN must be connected to the terminal which is marked with the letter L or coloured RED.

Making sure that neither core is connected to the earth terminal of the three pin plug.

\* This applies only to products distributed by Yamaha Music U.K. Ltd.

(2 wires)

## COMPLIANCE INFORMATION STATEMENT (DECLARATION OF CONFORMITY PROCEDURE)

Responsible Party : Yamaha Corporation of America  
Address : 6600 Orangethorpe Ave., Buena Park, Calif. 90620  
Telephone : 714-522-9011  
Type of Equipment : Digital Piano  
Model Name : YDP-V240

This device complies with Part 15 of the FCC Rules.

Operation is subject to the following two conditions:

- 1) this device may not cause harmful interference, and
- 2) this device must accept any interference received including interference that may cause undesired operation.

See user manual instructions if interference to radio reception is suspected.

\* This applies only to products distributed by YAMAHA CORPORATION OF AMERICA.

(FCC DoC)

Die Seriennummer dieses Produkts befindet sich an der Unterseite des Geräts. Sie sollten die Nummer des Modells, die Seriennummer und das Kaufdatum an den unten vorgesehenen Stellen eintragen und diese Anleitung als Dokument Ihres Kaufs aufbewahren.

Modellnr.

Seriennr.

Vous pouvez trouver le numéro de série de ce produit sur le bas de l'unité. Notez ce numéro de série dans l'espace fourni ci-dessous et conservez ce manuel en tant que preuve permanente de votre achat afin de faciliter l'identification du produit en cas de vol.

N° de modèle

N° de série

El número de serie de este producto se encuentra en la parte inferior de la unidad. Debe tomar nota del número de serie en el espacio proporcionado a continuación y conservar este manual como registro permanente de su adquisición; todo ello facilitará la identificación en caso de robo.

Modelo nº

Serie nº

(bottom)

# PRECAUTIONS

## PLEASE READ CAREFULLY BEFORE PROCEEDING

\* Please keep this manual in a safe place for future reference.



### WARNING

Always follow the basic precautions listed below to avoid the possibility of serious injury or even death from electrical shock, short-circuiting, damages, fire or other hazards. These precautions include, but are not limited to, the following:

#### Power supply/Power cord

- Only use the voltage specified as correct for the instrument. The required voltage is printed on the name plate of the instrument.
- Check the electric plug periodically and remove any dirt or dust which may have accumulated on it.
- Use only the supplied power cord/plug.
- Do not place the power cord near heat sources such as heaters or radiators, and do not excessively bend or otherwise damage the cord, place heavy objects on it, or place it in a position where anyone could walk on, trip over, or roll anything over it.

#### Do not open

- Do not open the instrument or attempt to disassemble the internal parts or modify them in any way. The instrument contains no user-serviceable parts. If it should appear to be malfunctioning, discontinue use immediately and have it inspected by qualified Yamaha service personnel.

#### Water warning

- Do not expose the instrument to rain, use it near water or in damp or wet conditions, or place containers on it containing liquids which might spill into any openings. If any liquid such as water seeps into the instrument, turn off the power immediately and unplug the power cord from the AC outlet. Then have the instrument inspected by qualified Yamaha service personnel.
- Never insert or remove an electric plug with wet hands.

#### Fire warning

- Do not put burning items, such as candles, on the unit. A burning item may fall over and cause a fire.

#### If you notice any abnormality

- If the power cord or plug becomes frayed or damaged, or if there is a sudden loss of sound during use of the instrument, or if any unusual smells or smoke should appear to be caused by it, immediately turn off the power switch, disconnect the electric plug from the outlet, and have the instrument inspected by qualified Yamaha service personnel.



### CAUTION

Always follow the basic precautions listed below to avoid the possibility of physical injury to you or others, or damage to the instrument or other property. These precautions include, but are not limited to, the following:

#### Power supply/Power cord

- When removing the electric plug from the instrument or an outlet, always hold the plug itself and not the cord. Pulling by the cord can damage it.
- Remove the electric plug from the outlet when the instrument is not to be used for extended periods of time, or during electrical storms.
- Do not connect the instrument to an electrical outlet using a multiple-connector. Doing so can result in lower sound quality, or possibly cause overheating in the outlet.

#### Assembly

- Read carefully the attached documentation explaining the assembly process. Failure to assemble the instrument in the proper sequence might result in damage to the instrument or even injury.

#### Location

- Do not expose the instrument to excessive dust or vibrations, or extreme cold or heat (such as in direct sunlight, near a heater, or in a car during the day) to prevent the possibility of panel disfiguration or damage to the internal components.
- Do not use the instrument in the vicinity of a TV, radio, stereo equipment, mobile phone, or other electric devices. Otherwise, the instrument, TV, or radio may generate noise.
- Do not place the instrument in an unstable position where it might accidentally fall over.
- Before moving the instrument, remove all connected cables.
- When setting up the product, make sure that the AC outlet you are using is easily accessible. If some trouble or malfunction occurs, immediately turn off the power switch and disconnect the plug from the outlet. Even when the power switch is turned off, electricity is still flowing to the product at the minimum level. When you are not using the product for a long time, make sure to unplug the power cord from the wall AC outlet.

## Connections

- Before connecting the instrument to other electronic components, turn off the power for all components. Before turning the power on or off for all components, set all volume levels to minimum. Also, be sure to set the volumes of all components at their minimum levels and gradually raise the volume controls while playing the instrument to set the desired listening level.

## Maintenance

- When cleaning the instrument, use a soft, dry or slightly damp cloth. Do not use paint thinners, solvents, cleaning fluids, or chemical-impregnated wiping cloths.
- During extreme changes in temperature or humidity, condensation may occur and water may collect on the surface of the instrument. If water is left, the wooden parts may absorb the water and be damaged. Make sure to wipe any water off immediately with a soft cloth.

## Handling caution

- Take care that the key cover does not pinch your fingers, and do not insert a finger or hand in any gaps on the key cover or instrument.
- Never insert or drop paper, metallic, or other objects into the gaps on the key cover, panel or keyboard. If this happens, turn off the power immediately and unplug the power cord from the AC outlet. Then have the instrument inspected by qualified Yamaha service personnel.
- Do not place vinyl, plastic or rubber objects on the instrument, since this might discolor the panel or keyboard.
- Do not rest your weight on, or place heavy objects on the instrument, and do not use excessive force on the buttons, switches or connectors.

- Do not use the instrument/device or headphones for a long period of time at a high or uncomfortable volume level, since this can cause permanent hearing loss. If you experience any hearing loss or ringing in the ears, consult a physician.

## Using the bench (if included)

- Do not place the bench in an unstable position where it might accidentally fall over.
- Do not play carelessly with or stand on the bench. Using it as a tool or step-ladder or for any other purpose might result in accident or injury.
- Only one person should sit on the bench at a time, in order to prevent the possibility of accident or injury.
- If the bench screws become loose due to extensive long-term use, tighten them periodically using the included tool.

## Saving data

### Saving and backing up your data

- The panel settings and some other types of data are not retained in memory when you turn off the power to the instrument. Save data you want to keep to the Registration Memory (page 90.)

Saved data may be lost due to malfunction or incorrect operation. Save important data to a USB storage device/ or other external device such as a computer (pages 98, 99, 109).

### Backing up the USB storage device/external media

- To protect against data loss through media damage, we recommend that you save your important data onto two USB storage devices/external media.

Yamaha cannot be held responsible for damage caused by improper use or modifications to the instrument, or data that is lost or destroyed.

Always turn the power off when the instrument is not in use.

The illustrations and LCD screens as shown in this manual are for instructional purposes only, and may appear somewhat different from those on your instrument.

## ● Trademarks

- The bitmap fonts used in this instrument have been provided by and are the property of Ricoh Co., Ltd.
- Windows is a registered trademark of Microsoft® Corporation in the United States and other countries.
- The company names and product names in this manual are the trademarks or registered trademarks of their respective companies.

## Copyright Notice

The followings are the titles, credits and copyright notices for three (3) of the songs pre-installed in this electronic keyboard:

Mona Lisa

from the Paramount Picture CAPTAIN CAREY, U.S.A.  
Words and Music by Jay Livingston and Ray Evans  
Copyright © 1949 (Renewed 1976) by Famous Music Corporation  
International Copyright Secured All Rights Reserved

Composition Title : Against All Odds  
Composer's Name : Collins 0007403  
Copyright Owner's Name : EMI MUSIC PUBLISHING LTD  
AND HIT & RUN MUSIC LTD

**All Rights Reserved, Unauthorized copying, public performance and broadcasting are strictly prohibited.**

Can't Help Falling In Love

from the Paramount Picture BLUE HAWAII  
Words and Music by George David Weiss,  
Hugo Peretti and Luigi Creatore  
Copyright © 1961 ; Renewed 1989 Gladys Music (ASCAP)  
Worldwide Rights for Gladys Music Administered by Cherry Lane  
Music Publishing Company, Inc.  
International Copyright Secured All Rights Reserved

This product incorporates and bundles computer programs and contents in which Yamaha owns copyrights or with respect to which it has license to use others' copyrights. Such copyrighted materials include, without limitation, all computer software, style files, MIDI files, WAVE data, musical scores and sound recordings. Any unauthorized use of such programs and contents outside of personal use is not permitted under relevant laws. Any violation of copyright has legal consequences. **DON'T MAKE, DISTRIBUTE OR USE ILLEGAL COPIES.**

Copying of the commercially available musical data including but not limited to MIDI data and/or audio data is strictly prohibited except for your personal use.

## Logos



### GM System Level 1

"GM System Level 1" is an addition to the MIDI standard which ensures that any GM-compatible music data can be accurately played by any GM-compatible tone generator, regardless of manufacturer. The GM mark is affixed to all software and hardware products that support GM System Level.



### XGlite

As its name implies, "XGlite" is a simplified version of Yamaha's high-quality XG tone generation format. Naturally, you can play back any XG song data using an XGlite tone generator. However, keep in mind that some songs may play back differently compared to the original data, due to the reduced set of control parameters and effects.



### XF

The Yamaha XF format enhances the SMF (Standard MIDI File) standard with greater functionality and open-ended expandability for the future. The instrument is capable of displaying lyrics when an XF file containing lyric data is played.



### STYLE FILE

The Style File Format is Yamaha's original style file format which uses a unique conversion system to provide high-quality automatic accompaniment based on a wide range of chord types.



### USB

USB is an abbreviation for Universal Serial Bus. It is a serial interface for connecting a computer with peripheral Devices. It allows "hot swapping" (connecting peripheral devices while the power to the computer is on).

*Congratulations and thank you for purchasing  
the Yamaha Digital Piano!*

*Please read this owner's manual carefully before using the instrument  
in order to take full advantage of its various features.*

*Make sure to keep this manual in a safe and handy place even after you finish reading,  
and refer to it often when you need to better understand an operation or function.*

## About this Owner's Manual and Data List

The documentation and reference materials for this instrument consist of the following: Owner's Manual (this book)

### ■ Introduction (page 2):

Please read this section first.

### ■ Reference (page 70):

This section explains how to make detailed settings for the instrument's various functions.

### ■ Appendix (page 110):

This section introduces reference material.

## Data List

You can download various MIDI-related reference materials, such as the MIDI Data Format and MIDI Implementation Chart, from the Yamaha Manual Library.

Connect to the Internet, visit the following website, type the model name of your instrument (such as "YDP-V240") in the Model Name text box, then click the Search button.

## Yamaha Manual Library

<http://www.yamaha.co.jp/manual/>

## Accessories

The package includes the following items. Please check that you have them all.

- Accessory CD-ROM
- Accessory CD-ROM for Windows Installation Guide
- Owner's manual (this book)
- Bench
  - \* A bench may be included or optional, depending on your locale.
- My Yamaha Product User Registration
  - \* The PRODUCT ID on the sheet will be needed when you fill out the User Registration form.

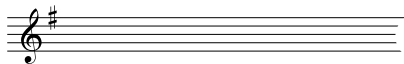

## Special Features

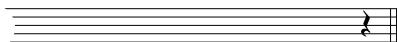

### GHS (Graded Hammer Standard) keyboard with matte black keytops

Graded Hammer Standard keyboard with matte black keytops on the instrument, feature graded key weight and response throughout the keyboard range. They respond to a heavier touch in the low range of the keyboard and a lighter touch in the higher range of the keyboard, thus providing natural grand-piano type playability. The matte finish of the black keys enhances keyboard's luxurious appearance. The Graded Hammer keyboard also offers superb playability for tremolo and other repetitive-striking techniques.

#### ■ Performance assistant technology ▶ Page 39

Play along with a song on the instrument's keyboard and produce a perfect performance every time ... even if you play wrong notes! All you have to do is play on the keyboard—alternately on the left- and right-hand ranges of the keyboard, for example—and you'll sound like a pro as long as you play in time with the music.

And if you can't play with both hands, you can still play the melody simply by tapping one key.



All you need is one finger!

#### ■ Play a Variety of Instrument Voices ▶ Page 17

The instrument voice that sounds when you play the keyboard can be changed to violin, flute, harp, or any of an extensive range of voices. You can change the mood of a song written for piano, for example, by using violin to play it instead. Experience a whole new world of musical variety.



#### ■ Play Along with Styles ▶ Page 27

Want to play with full accompaniment? Try the auto-accompaniment Styles. The accompaniment styles provide the equivalent of a full backing band covering wide variety of styles from waltzes to 8-beat to euro-trance ... and much more. Select a style that matches the music you want to play, or experiment with new styles to expand your musical horizons.

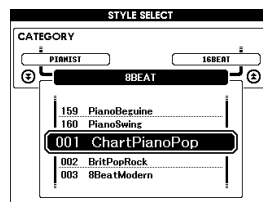

#### ■ Easy Performance with Music Notation Display ▶ Page 37

When you play back a song, the corresponding score will be shown on the display as the song plays. This is a great way to learn how to read music. If the song contains lyric and chord data\*, the lyrics and chords will also appear on the score display.

\* No lyrics or chords will appear on the display if the song you are using with the score display function does not contain the appropriate lyric and chord data.

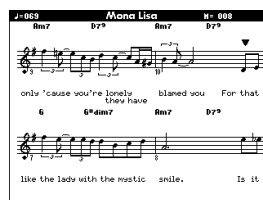



# Contents

## Introduction

Copyright Notice .....	6
Logos .....	6
About this Owner's Manual and Data List .....	7
Accessories .....	7
Special Features .....	8

## Setting Up

Key Cover .....	10
Music Rest .....	10
Connecting to a Computer (USB TO HOST terminal) .....	11
Turning the Power On .....	11
Using Headphones .....	12
Maintenance .....	13

## Panel Controls and Terminals

Front Panel .....	15
Pedals, Jacks and Terminals .....	15

## Quick Guide

### Changing the Display Language

16

### Try Playing a Variety of Instrument Voices

17

Select and Play a Voice—MAIN .....	17
Play Two Voices Simultaneously—DUAL .....	18
Play Different Voices with the Left and Right Hands—SPLIT .....	19
Play the Grand Piano Voice .....	20
Using the Pedals .....	21

### Fun Sounds

22

Drum Kits .....	22
Sound Effects .....	22

### The Metronome

23

Start the Metronome .....	23
Adjusting the Metronome Tempo .....	23
Setting the Number of Beats per Measure, and the Length of Each Beat .....	24
Setting the Click bell sound .....	25
Adjusting the Metronome Volume .....	25

### Playing Styles

26

Select a Style Rhythm .....	26
Play Along with a Style .....	27
Playing Auto-accompaniment Chords .....	31

### Using Songs

32

Play the Demo song .....	32
Select and Listen to a Song .....	33
Song Fast Forward, Fast Reverse, and Pause .....	34
Change the Song Tempo .....	34
Song List .....	35
Types of Songs .....	36
Displaying the Song Score .....	37
Display the Lyrics .....	38

### The Easy Way to Play Piano

39

CHORD Type—Play with Both Hands .....	40
CHORD/FREE Type— Applying the Chord Type to the Left Hand Only .....	42
MELODY Type—Play with One Finger .....	44
CHORD/MELODY— Chord Type with the Left Hand, Melody with the Right .....	46

### Select a Song For a Lesson

50

Lesson 1—Waiting .....	51
Lesson 2—Your Tempo .....	54
Lesson 3—Minus One .....	55
Practice Makes Perfect—Repeat and Learn .....	56

### Play Using the Music Database

57

### Change a Song's Style

58

Try Out the Easy Song Arranger .....	58
Using the Easy Song Arranger .....	58

### Record Your Own Performance

60

Recording Procedure .....	61
Song Clear—Deleting User Songs .....	63
Track Clear—Deleting a Specified Track from a User Song ..	64

## Backup and Initialization

65

Backup .....	65
Initialization .....	65

## Basic Operation

66

Basic Operation .....	66
The Displays .....	68
MAIN Display Items .....	69

## Reference

### Play with a Variety of Effects

70

Adding Harmony .....	70
Adding Reverb .....	71
Adding Chorus .....	72
Adding DSP .....	73
Adding Sustain .....	74

### Handy Performance Features

75

Tap Start .....	75
Touch Response Sensitivity .....	75
One Touch Setting .....	76
Select a Sound Type .....	77
Pitch Controls .....	78

### Style (Auto-accompaniment) Functions

79

Pattern Variation (Sections) .....	79
Setting the Split Point .....	82
Play a Style with Chords but No Rhythm (Stop Accompaniment) .....	83
Adjusting the Style Volume .....	83
Chord Basics .....	84
Playing Styles Using the Entire Keyboard .....	86
Looking Up Chords Using the Chord Dictionary .....	87

### Song Settings

88

Song Volume .....	88
A-B Repeat .....	88
Muting Independent Song Parts .....	89
Change the Melody Voice .....	89

### Memorize Your Favorite Panel Settings

90

Saving to the Registration Memory .....	90
Recalling a Registration Memory .....	91

### The Functions

92

Selecting and Setting Functions .....	92
---------------------------------------	----

### Saving and Loading Data

95

Connecting a USB Flash Memory .....	95
Formatting USB Flash Memory .....	97
Saving Registration Memory data to USB Flash Memory .....	98
Save a User Song to USB Flash Memory .....	99
Loading Files from a USB Flash Memory .....	100
Deleting Data from a USB Flash Memory .....	101
Delete User Data from the Instrument .....	102
Playing Files Located on a USB Flash Memory .....	102

### Connections

103

Connectors .....	103
Connecting a Personal Computer .....	104
Transferring Performance Data to and from a Computer .....	105
Remote Control of MIDI Devices .....	106
Initial Send .....	107
Transferring Data Between the Computer and Instrument ..	107

## Appendix

Troubleshooting .....	110
Messages .....	112

### Keyboard Stand Assembly

114

Index .....	118
Scores .....	120
Voice List .....	126
Drum Kit List .....	132
Style List .....	134
Music Database List .....	135
Songs Provided On the Supplied CD-ROM .....	136
Harmony Type List .....	137
Effect Type List .....	138
Specifications .....	144



# Setting Up

## Key Cover

### ■ To open the key cover:

Lift the cover slightly, then push and slide it open.

### ■ To close the key cover:

Slide the cover toward you and gently lower the cover over the keys.

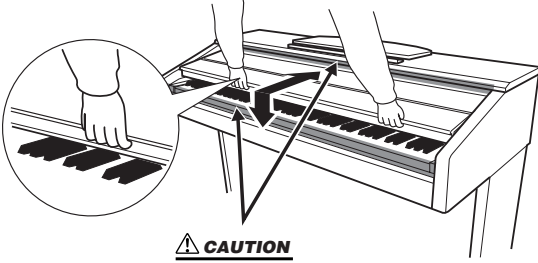

#### ⚠ CAUTION

- Be careful to avoid catching your fingers when opening or closing the cover.

#### ⚠ CAUTION

- Hold the cover with both hands when opening or closing it. Do not release it until it is fully opened or closed. Be careful to avoid catching fingers (yours or others, especially children's) between the cover and main unit.

#### ⚠ CAUTION

- Do not place objects, such as a piece of metal or paper, on top of the key cover. Small objects placed on the key cover may fall inside the unit when the cover is opened and may be nearly impossible to remove. This could cause electric shock, short circuit, fire or other serious damage to the instrument.

## Music Rest

### ■ To raise the music rest:

- 1 Pull the music rest up and toward yourself as far as it will go.
- 2 Flip down the two metal supports at the left and right on the rear of the music rest.
- 3 Lower the music rest so that it rests on the metal supports.

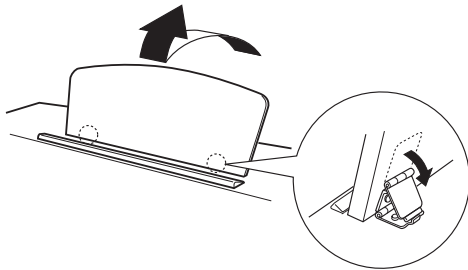

### ■ To lower the music rest:

- 1 Pull the music rest toward yourself as far as it will go.
- 2 Raise the two metal supports (at the rear of the music rest).
- 3 Gently lower the music rest backward until it is all the way down.

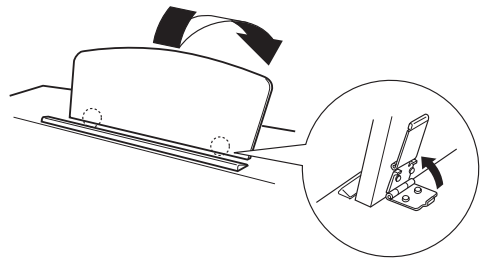

#### ⚠ CAUTION

- Do not try to use the music rest in a half-raised position. When lowering the music rest, do not release your hands from the music rest until it is all the way down.

## Connecting to a Computer (USB TO HOST terminal)

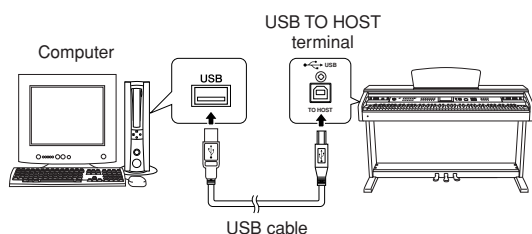

Connect the instrument's USB TO HOST terminal to the USB terminal of a computer, and you can transfer performance data and song files between the two (page 104). To use the USB data-transfer features you'll need to do the following:

- **First, make sure the POWER switch on the instrument is set to OFF, then use an AB type USB cable to connect the instrument to the computer. After making the connections, turn the instrument's power on.**
- **Install the USB-MIDI driver on your computer.**

Installation of the USB-MIDI driver is described on the "Accessory CD-ROM Installation Guide".

## Turning the Power On

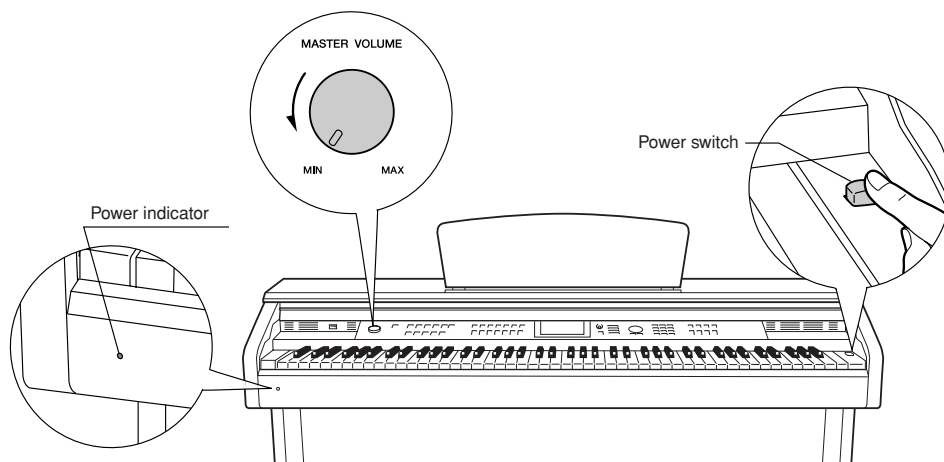

- 1 Turn down the volume by turning the [MASTER VOLUME] control to the left.**
- 2 Check the power cord to make sure it is connected properly. (See page 116.)**
- 3 Press the power switch to turn on the power.**

Press the power switch again to turn the power OFF.

### NOTE

#### Power indicator

- If you forget to turn off the power to the instrument and close the key cover, the power indicator will remain lit, indicating that the power is still on.

Backup data in the flash memory is loaded to the instrument when the power is turned on. If no backup data exists on flash memory, all instrument settings are restored to the initial factory defaults when the power is turned on.

### CAUTION

- *Even when the switch is in the "off" position, electricity is still flowing to the instrument at the minimum level. When you are not using the instrument for a long time, make sure you unplug the AC power cord from the wall AC outlet.*

### CAUTION

- *Never attempt to turn the power off when a "WRITING!" message is shown in the display. Doing so can damage the flash memory and result in a loss of data.*

## Using Headphones

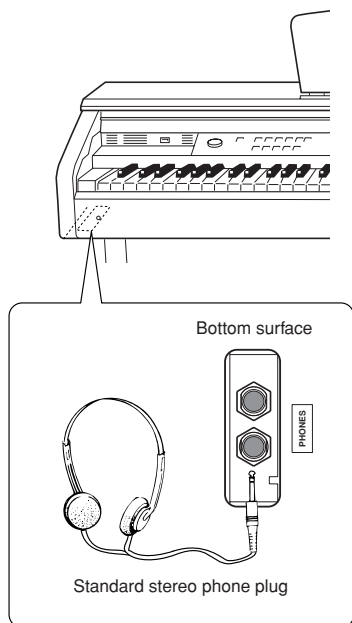

Connect a pair of headphones to one of the [PHONES] jacks.

Two [PHONES] jacks are provided.

You can connect two sets of standard stereo headphones. (If you are using only one pair of headphones, you can plug them into either jack.)

## Using the Headphone Hanger

A headphone hanger is included in the package so that you can hang the headphones on this instrument. Install the headphone hanger using the included two screws (4 x 10mm) as shown in the figure.

### **CAUTION**

- Do not hang anything other than the headphones on the hanger. Otherwise, this instrument or the hanger may be damaged.

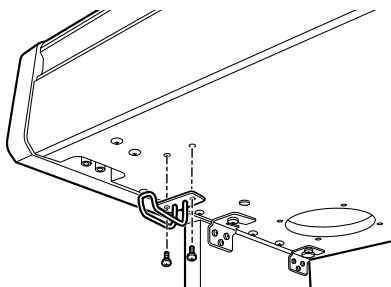

## Maintenance

To keep your instrument in optimum condition, we recommend that you periodically follow the maintenance points below.

### ■ Instrument and Bench Maintenance

When cleaning the instrument, use a soft, dry or slightly damp cloth.

#### CAUTION

- Do not use paint thinners, solvents, cleaning fluids, or chemical-impregnated wiping cloths.

Tighten the screws of the instrument and bench periodically.

### ■ Pedal Cleaning

As with an acoustic piano, pedals may become tarnished across the ages. When this occurs, polish the pedal with a compound designed for piano pedals. Before using the compound, make sure to read the instructions for proper usage.

#### CAUTION

- Do not use paint thinners, solvents, cleaning fluids, or chemical-impregnated wiping cloths. Otherwise, the pedal may become discolored or degraded.

### ■ Tuning

Unlike an acoustic piano, the instrument does not need to be tuned. It always stays perfectly in tune.

### ■ Transporting

If you move to another location, you can transport the instrument along with other belongings. You can move the unit as it is (assembled) or you can disassemble the unit down to the condition it was in when you first took it out of the box. Transport the keyboard horizontally. Do not lean it up against a wall or stand it up on its side. Do not subject the instrument to excessive vibration or shock.

When transporting the assembled instrument, make sure all screws are properly tightened and have not been loosened by moving the instrument.



# Panel Controls and Terminals

## Front Panel

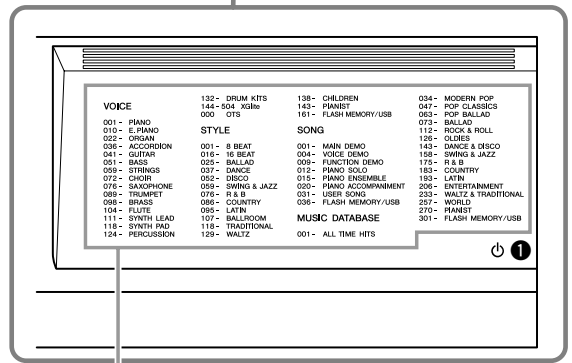
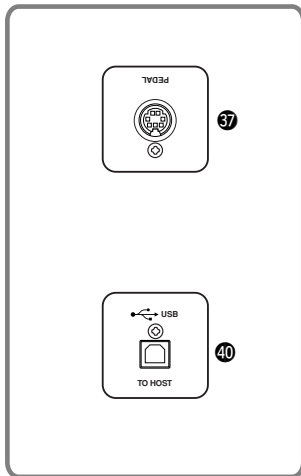
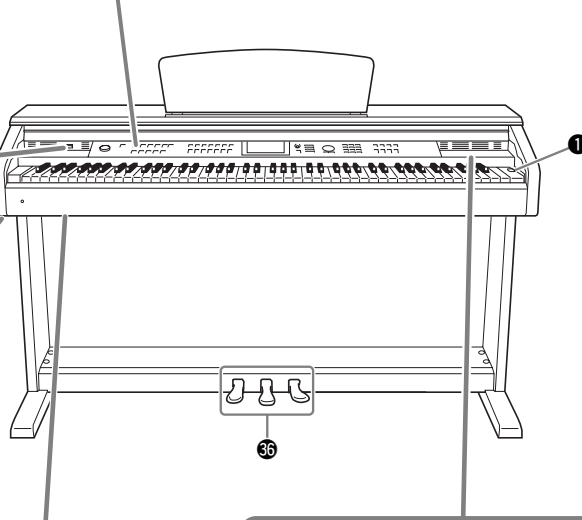
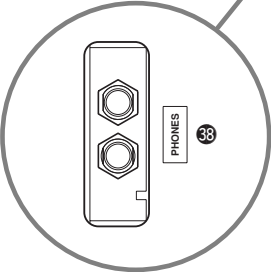
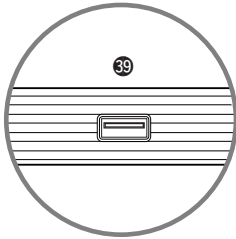
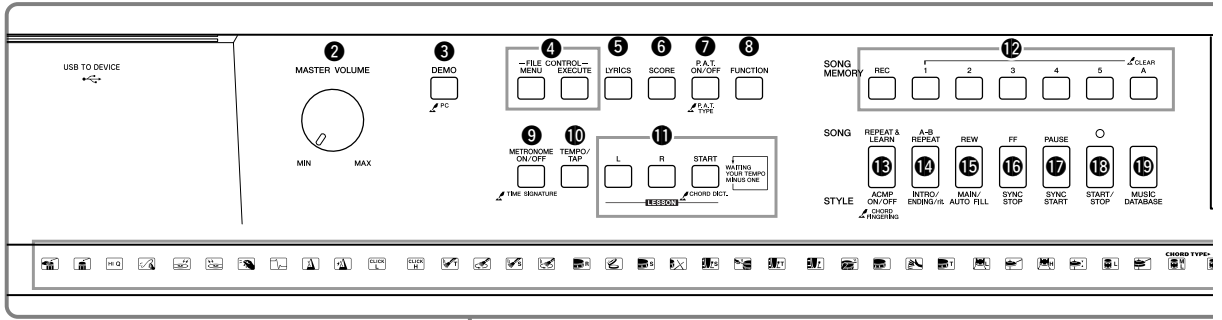

- Voice Category List (page 126)
- Style Category List (page 134)
- Song Category List (page 35)
- Music Database List (page 135)

Display (pages 68, 69)

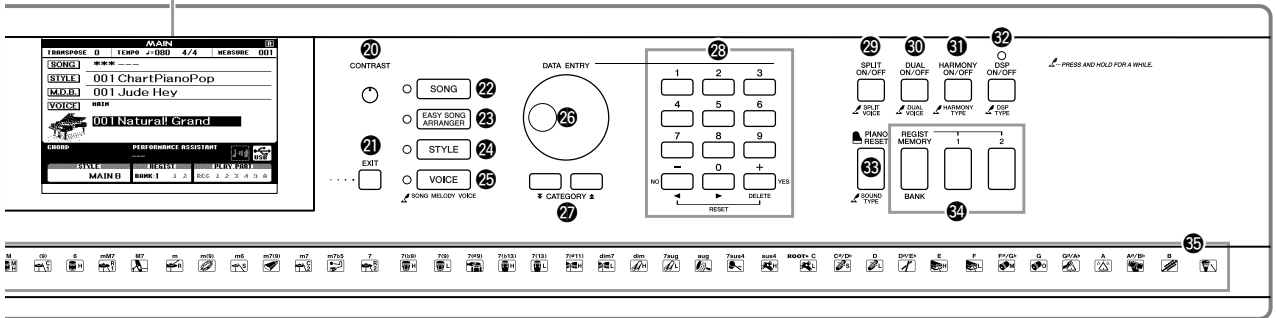

Front Panel

- 1 Power switch (⏻) .....page 11
- 2 [MASTER VOLUME] control .....pages 11, 66
- 3 [DEMO] button .....page 32
- 4 FILE CONTROL [MENU], [EXECUTE] buttons.....pages 95–101
- 5 [LYRICS] button .....page 38
- 6 [SCORE] button .....page 37
- 7 [P.A.T. ON/OFF] button.....page 40
- 8 [FUNCTION] button .....pages 68, 92
- 9 [METRONOME ON/OFF] button .....page 23
- 10 [TEMPO/TAP] button .....pages 34, 75
- 11 LESSON [L], [R], [START] buttons .....page 51
- 12 SONG MEMORY [REC], [1]–[5], [A] buttons .....page 61
- 13 [REPEAT & LEARN]/ [ACMP ON/OFF] button .....pages 56, 27
- 14 [A-B REPEAT]/ [INTRO/ENDING/rit.] button .....pages 88, 79
- 15 [REW]/[MAIN/AUTO FILL] button ...pages 34, 79
- 16 [FF]/[SYNC STOP] button .....pages 34, 81
- 17 [PAUSE]/[SYNC START] button.....pages 34, 80
- 18 [START/STOP] button .....pages 26, 33, 67
- 19 [MUSIC DATABASE] button .....page 57
- 20 [CONTRAST] knob ..... page 69
- 21 [EXIT] button ..... page 68
- 22 [SONG] button ..... page 33
- 23 [EASY SONG ARRANGER] button ..... page 58
- 24 [STYLE] button ..... page 26
- 25 [VOICE] button ..... page 17
- 26 Dial .....pages 67, 92
- 27 CATEGORY [▲] and [▼] buttons .....pages 67, 92
- 28 Number buttons [0]–[9], [+ ] and [- ] buttons .....pages 67, 92
- 29 [SPLIT ON/OFF] button ..... page 19
- 30 [DUAL ON/OFF] button ..... page 18
- 31 [HARMONY ON/OFF] button ..... page 70
- 32 [DSP ON/OFF] button ..... page 73
- 33 [PIANO RESET] button ..... page 20
- 34 REGIST MEMORY [MEMORY/BANK], [1], [2] buttons ..... page 90
- 35 Drum Kit ..... page 22  
The illustrations above each key indicate the drum and percussion instruments assigned to the keys when “Standard Kit 1” is selected.

Pedals, Jacks and Terminals

- 36 Pedals .....page 21
- 37 [PEDAL] jack .....page 116
- 38 [PHONES] jacks .....page 12
- 39 USB TO DEVICE terminal ..... page 96
- 40 USB TO HOST terminal ..... page 104



# Changing the Display Language

This instrument allows you to select English or Japanese as the display language. The default display language is English, but if you switch to Japanese the lyrics, file names, demo display, and some messages will be displayed in Japanese where appropriate.

## 1 Press the [FUNCTION] button.

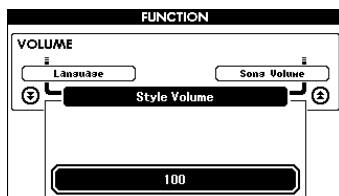
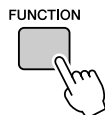

## 2 Press the CATEGORY [▲] and [▼] buttons a number of times until the “Language” item appears.

The currently selected display language will appear below the “Language” item.

When highlighted you can use the [+] and [-] buttons to select the language as required.

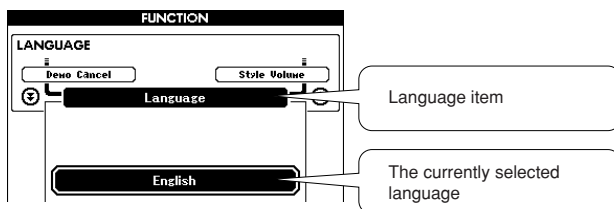
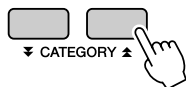

## 3 Select a display language.

The [+] button selects English and the [-] button selects Japanese.

The language selection will be stored in the internal flash memory so that it is retained even when the power is turned off.

## 4 Press the [EXIT] button to return to the MAIN display.





# Try Playing a Variety of Instrument Voices

In addition to piano, organ, and other “standard” keyboard instruments, this instrument has a large range of voices that includes guitar, bass, strings, sax, trumpet, drums and percussion, sound effects ... a wide variety of musical sounds.

## Select and Play a Voice—MAIN

This procedure selects the main voice you will play on the keyboard.

### 1 Press the [VOICE] button.

The main voice selection display will appear.  
The currently selected voice number and name will be highlighted.

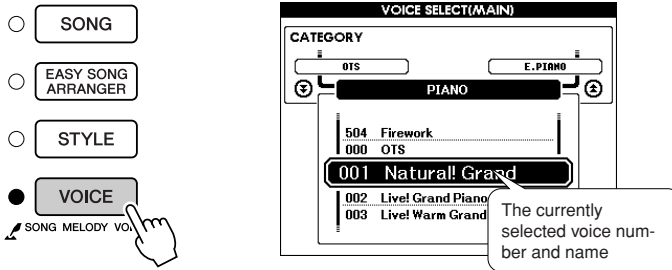

### 2 Select the voice you want to play.

While watching the highlighted voice name rotate the dial. The available voices will be selected and displayed in sequence. The voice selected here becomes the main voice.  
For this example select the “106 Flute” voice.

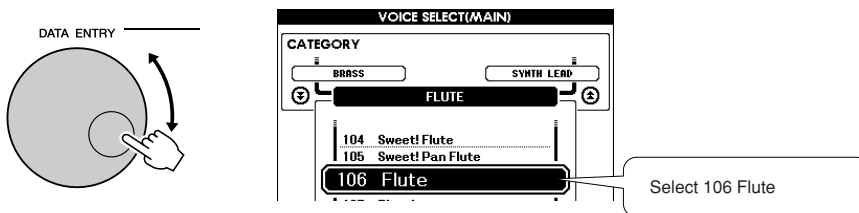

### 3 Play the keyboard.

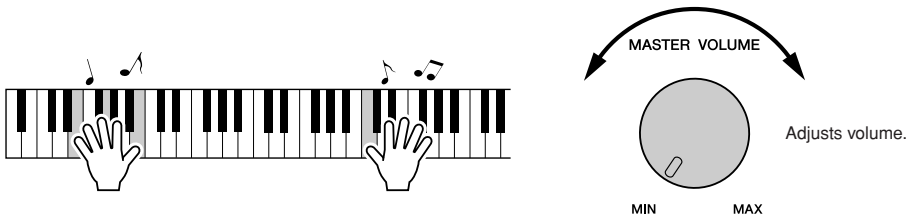

Try selecting and playing a variety of voices.  
Press the [EXIT] button to return to the MAIN display.

## Play Two Voices Simultaneously—DUAL

You can select a second voice which will play in addition to the main voice when you play the keyboard. The second voice is known as the “dual” voice.

### 1 Press the [DUAL ON/OFF] button.

The [DUAL ON/OFF] button turns the dual voice on or off. When turned on the dual voice “DUAL” will appear in the MAIN display. The currently selected dual voice will sound in addition to the main voice when you play the keyboard.

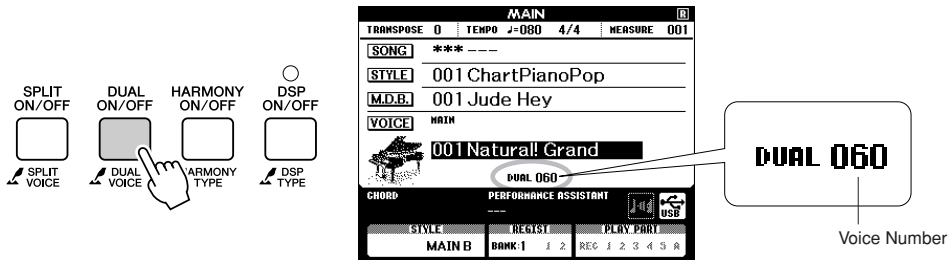

### 2 Press and hold the [DUAL ON/OFF] button for longer than a second.

The dual voice selection display will appear.

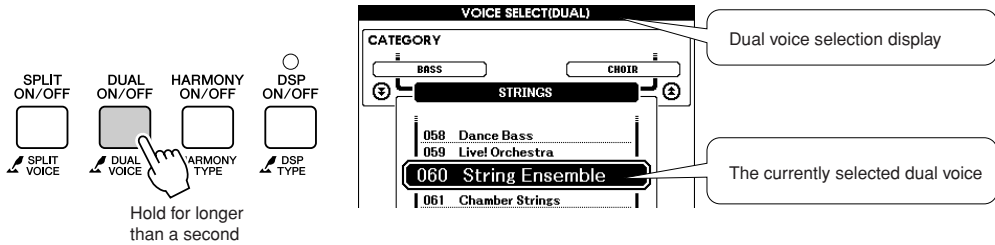

### 3 Select the desired dual voice.

Watch the displayed dual voice and rotate the dial until the voice you want to use is selected. The voice selected here becomes the dual voice. For this example try selecting the “124 Vibraphone” voice.

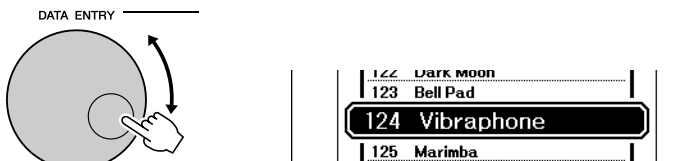

# 4 Play the keyboard.

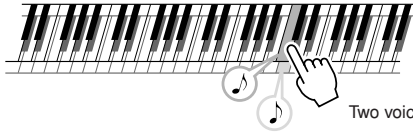

Two voices will sound at the same time.

Try selecting and playing a range of dual voices.

Press the [EXIT] button to return to the MAIN display.

## Play Different Voices with the Left and Right Hands—SPLIT

In the split mode you can play different voices to the left and right of the keyboard “split point”. The main and dual voices can be played to the right of the split point, while the voice played to the left of the split point is known as the “split voice”. The split point setting can be changed as required (page 82).

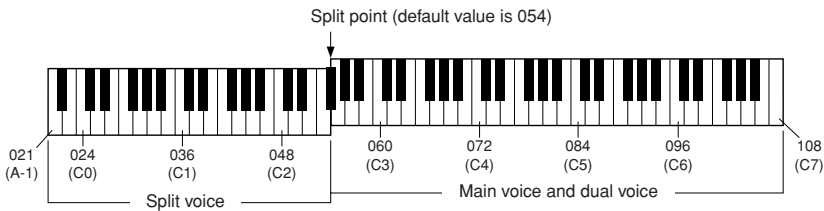

# 1 Press the [SPLIT ON/OFF] button.

The [SPLIT ON/OFF] button turns the split voice on or off. When turned on the split voice “SPLIT” will appear in the MAIN display. The currently selected split voice will sound to the left of the keyboard split point.

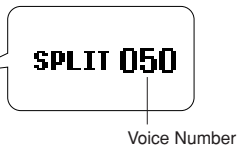
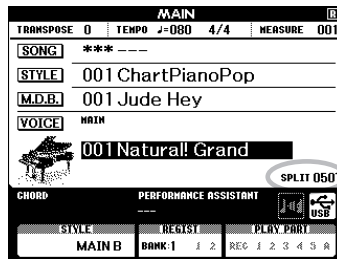
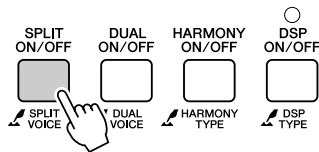

# 2 Press and hold the [SPLIT ON/OFF] button for longer than a second.

The split voice selection display will appear.

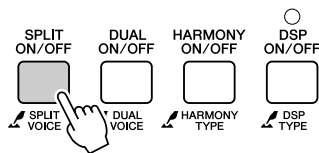

Hold for longer than a second

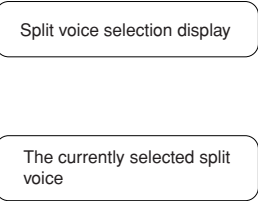
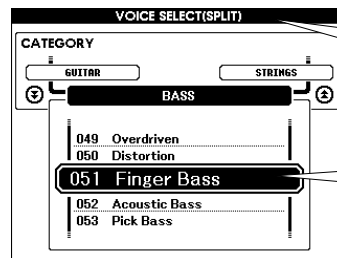

### 3 Select the desired split voice.

Watch the highlighted split voice and rotate the dial until the voice you want to use is selected. The voice selected here becomes the split voice which will play to the left of the keyboard split point. For this example try selecting the “042 Folk Guitar” voice.

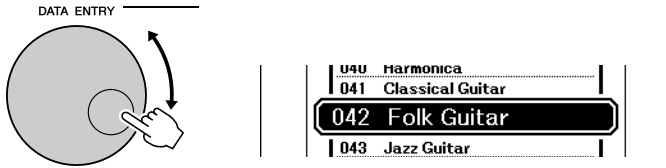

### 4 Play the keyboard.

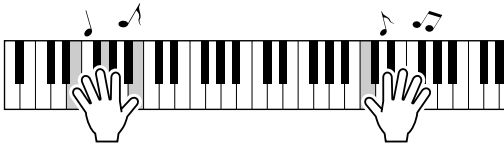

Try selecting and playing a range of split voices.

Press the [EXIT] button to return to the MAIN display.

## Play the Grand Piano Voice

When you just want to play piano, all you have to do is press one convenient button.

### Press the [PIANO RESET] button.

The “001 Natural! Grand Piano” voice will be selected.

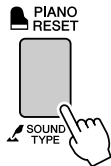

#### NOTE

- When you press the [PIANO RESET] button all settings other than touch sensitivity are turned off. The dual and split voices will also be turned off, so only the Grand Piano voice will play over the entire keyboard.

## Using the Pedals

The instrument has three foot pedals that produce a range of expressive effects similar to those produced by the pedals on an acoustic piano.

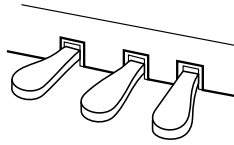

### NOTE

- The pedal functions do not affect Split voice.

### NOTE

- If the damper pedal doesn't work, make sure that the pedal cord is properly plugged into the jack (page 116).

### NOTE

#### Half-pedal:

- While playing the piano with Sustain and you want to slightly mute the sustained sound, release the damper pedal from maximum position to half position.

### Damper (Right) Pedal

The damper pedal functions in the same way as a damper pedal on an acoustic piano. When the damper pedal is pressed, notes sustain longer. Releasing the pedal immediately stops (damps) any sustained notes. The damper pedal also features a naturally expressive half-pedal function.

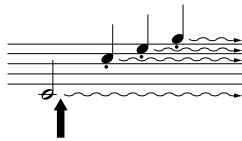

When you press the damper pedal here, the notes you play before you release the pedal have a longer sustain.

### Sostenuto (Center) Pedal

If you play a note or chord on the keyboard and press the sostenuto pedal while the note(s) are held, those notes will sustain as long as you hold the pedal (as if the damper pedal had been pressed) but all subsequently played notes will not be sustained. This makes it possible to sustain a chord, for example, while other notes are played “staccato.”

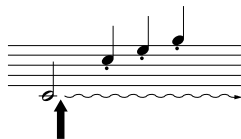

When you press the sostenuto pedal here while holding the note, the note will sustain as long as you hold the pedal.

### NOTE

- Organ, string and choir voices will continue to sound for as long as the sostenuto pedal is depressed.

### Soft (Left) Pedal

The soft pedal reduces the volume and slightly changes the timbre of notes played while the pedal is pressed. The soft pedal will not affect notes that are already playing when it is pressed.



# Fun Sounds

This instrument includes a range of drum kits and unique sound effects you can use for entertainment. Laughter, babbling brooks, jet fly-bys, eerie effects, and much more. These sounds can be a great way to enhance the mood at parties.

## Drum Kits

Drum kits are collections of drum and percussion instruments. When you select a violin or other normal instrument main voice, for example, all keys produce the sound of the same violin, only at different pitches. If you select a drum kit as the main voice, however, each key produces the sound of a different drum or percussion instrument.

### ◆ Drum Kit Selection Procedure → (refer to steps 1 and 2 on page 17)

- 1 Press the [VOICE] button.
- 2 Use the dial to select “132 Standard Kit 1”.
- 3 Try out each key and enjoy the drum and percussion sounds!

Try out each key and enjoy the drum and percussion sounds! Don't forget the black keys! You'll hear a triangle, maracas, bongos, drums ... a comprehensive variety of drum and percussion sounds. For details on the instruments included in the drum kit voices (voice numbers 132 to 143), see the “Drum Kit List” on page 132.

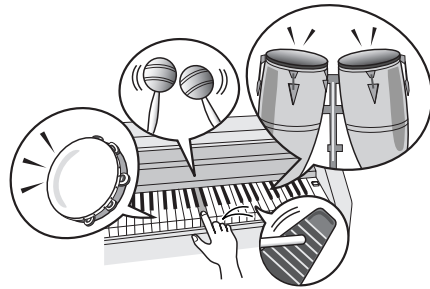

## Sound Effects

The sound effects are included in the drum kit voice group (voice numbers 142 and 143). When either of these voices are selected you will be able to play a range of sound effects on the keyboard.

### ◆ Sound Effect Selection Procedure → (refer to steps 1 and 2 on page 17)

- 1 Press the [VOICE] button.
- 2 Use the dial to select “143 SFX Kit 2”.
- 3 Try out each key and enjoy the sound effects!

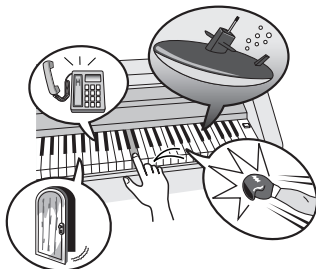

As you try out the various keys you'll hear the sound of a submarine, a telephone bell, a creaking door, and many other useful effects. “142 SFX Kit 1” includes lightning, running water, dogs barking, and others. Some keys do not have assigned sound effects, and will therefore produce no sound.

For details on the instruments included in the SFX kit voices, see “SFX Kit 1” and “SFX Kit 2” in the “Drum Kit List” on page 133.





# The Metronome

The instrument includes a metronome with adjustable tempo and time signature. Play and set the tempo that is most comfortable for you.

## Start the Metronome

Turn the metronome on and start it by pressing the [METRONOME ON/OFF] button.

To stop the metronome, press the [METRONOME ON/OFF] button again.

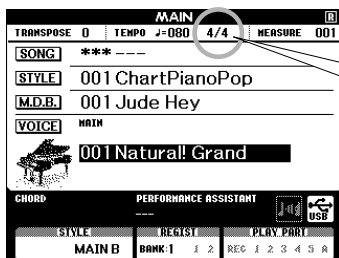
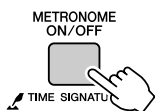

## Adjusting the Metronome Tempo

**1** Press the [TEMPO/TAP] button to call up the tempo setting.



**2** Use the dial to select a tempo from 5 to 280.

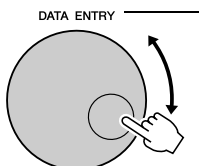

## Setting the Number of Beats per Measure, and the Length of Each Beat

In this example we'll set up a 5/8 time signature.

- 1 Press and hold the [METRONOME ON/OFF] button for longer than a second to select the function "Time Signature-Numerator".

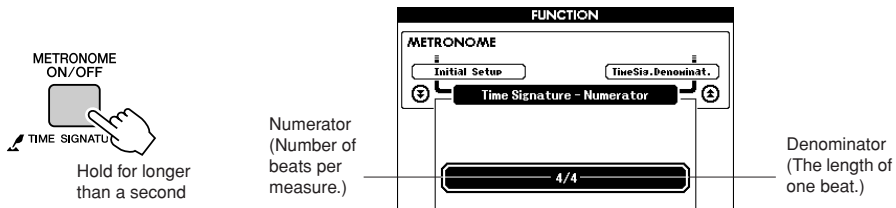

- 2 Use the dial to select the number of beats per measure. The available range is from 1 through 60. Select 5 for this example. A bell accent will be sounded at the first beat of each measure.

**NOTE**

The metronome time signature will synchronize to a style or song that is playing, so these parameters cannot be changed while a style or song is playing.

- 3 Press the CATEGORY [▲] and [▼] buttons as many times as necessary to select the beat length function "Time Signature-Denominator".

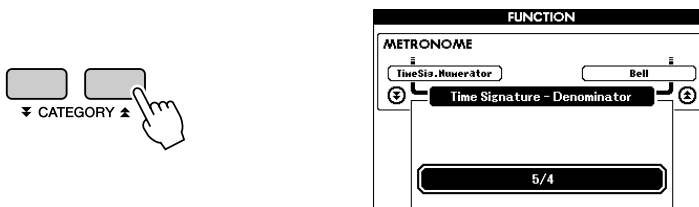

- 4 Use the dial to select the beat length. Select the required length for each beat: 2, 4, 8, or 16 (half note, quarter note, eighth note, or 16th note). Select 8 for this example.

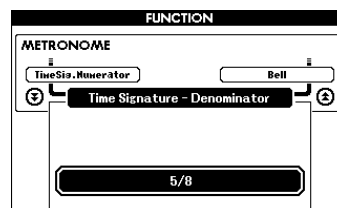



## Setting the Click bell sound

This allows you to select whether the click sound has a bell accent, or plays only a click sound.

- 1 Press the [FUNCTION] button.

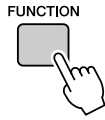

- 2 Use the CATEGORY [▲] and [▼] buttons to select the Bell item.

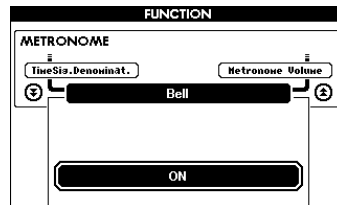
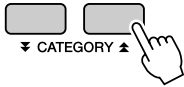

- 3 You can then use the [+] and [-] buttons to turn the bell sound on or off.

## Adjusting the Metronome Volume

- 1 Press the [FUNCTION] button.

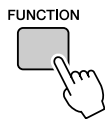

- 2 Use the CATEGORY [▲] and [▼] buttons to select the Metronome Volume item.

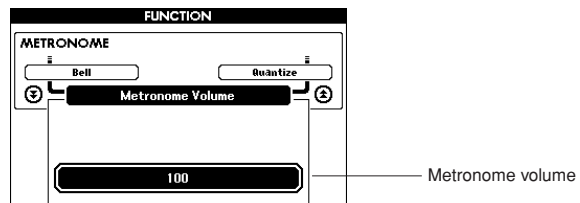
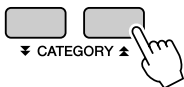

- 3 Use the dial to set the metronome volume as required.



# Playing Styles

This instrument has an auto accompaniment feature that produces accompaniment (rhythm + bass + chords) in the style you choose to match chords you play with your left hand. You can select from 160 different styles covering a range of musical genres and time signatures (see page 134 for a complete list of the available styles). In this section we'll learn how to use the auto accompaniment features.

## Select a Style Rhythm

Most styles includes a rhythm part. You can select from a wide variety of rhythmic types—rock, blues, Euro trance, and many, many more. Let's begin by listening to just the basic rhythm. The rhythm part is played using percussion instruments only.

### 1 Press the [STYLE] button.

The style select display will appear. The currently selected style number and name will be highlighted.

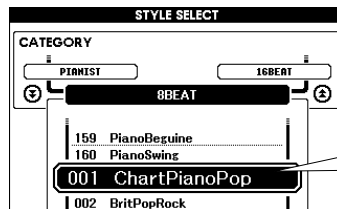
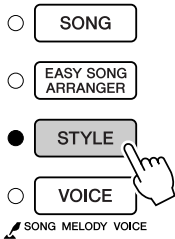

The currently selected style

#### NOTE

When you play the style, set the Sound Type to "Style." Doing this a more natural, enhanced sound over the internal speakers (see page 77). However, when using the headphones, normal sound is applied.

### 2 Select a style.

Use the dial to select the style you want to use. A list of all the available styles is provided on page 134.

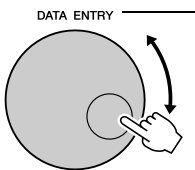

#### NOTE

Style files transferred from a computer or stored on a USB flash memory device connected to the instrument can be selected and used in the same way as the internal Styles (Style numbers 161–). File transfer instructions are provided on page 107.

### 3 Press the [START/STOP] button.

The style rhythm will start playing. Press the [START/STOP] button a second time when you want to stop playback.

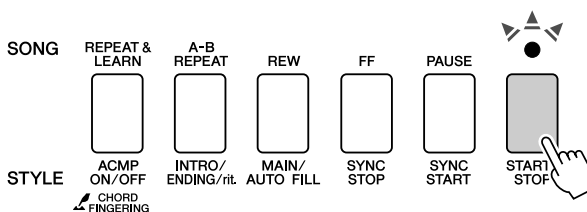

#### NOTE

Style numbers 131, 143–160 have no rhythm part and therefore no rhythm will play if you use them for the above example. For these styles first turn auto accompaniment on as described on page 27, press the [START/STOP] button, and the accompaniment bass and chord parts will begin playing when you play a key to the left of the keyboard split point.

# Play Along with a Style

You learned how to select a style rhythm on the preceding page. Here we'll see how to add bass and chord accompaniment to the basic rhythm to produce a full, rich accompaniment that you can play along with.

**1** Press the [STYLE] button and select the desired style.

**2** Turn automatic accompaniment on.

Press the [ACMP ON/OFF] button.

Pressing this button a second time will turn automatic accompaniment off.

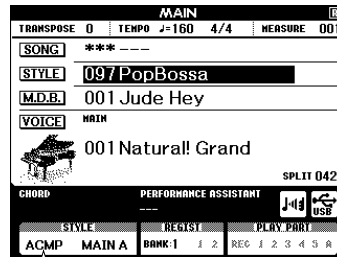
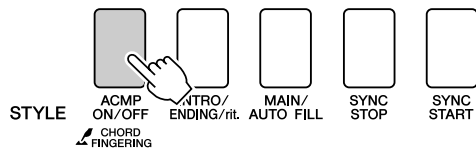

**STYLE:**  
ACMP MAIN A

This icon appears when automatic accompaniment is on.

● **When automatic accompaniment is on ...**

The area of the keyboard to the left of the split point (054: F#2) becomes the “auto accompaniment region” and is used only for specifying the accompaniment chords.

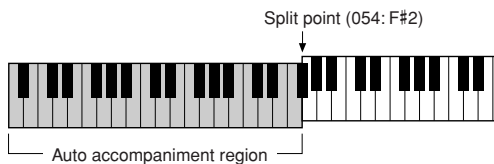

**NOTE**

- The keyboard split point can be changed as required: refer to page 82.

**3** Turn sync start on.

Press the [SYNC START] button to turn the sync start function on.

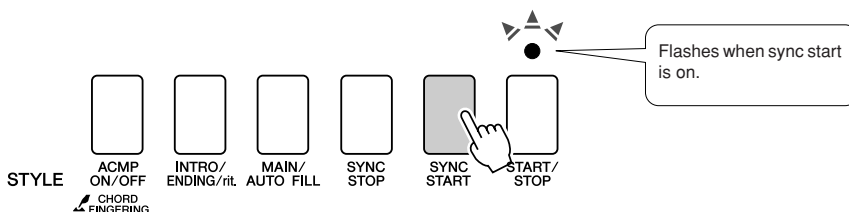

When sync start is on, the bass and chord accompaniment included in a style will start playing as soon as you play a note to left of the keyboard split point. Press the button a second time to turn the sync start function off.

## 4 Play a left-hand chord to start the style.

You can still “play” chords even if you don’t actually know any chords. This instrument will recognize even a single note as a chord. Try playing from one to three notes at the same time to the left of the split point. The accompaniment will change according to the left-hand notes you play.

### Try this!

Scores for some chord progressions are provided on page 29. These examples should help you get a feel for what types of chord progressions sound good with the styles.

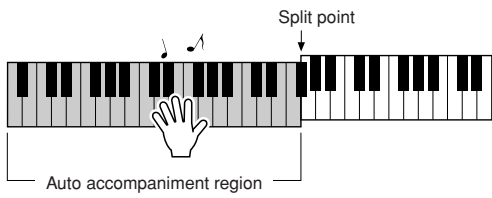

## 5 Play a variety of left-hand chords while playing a melody with your right hand.

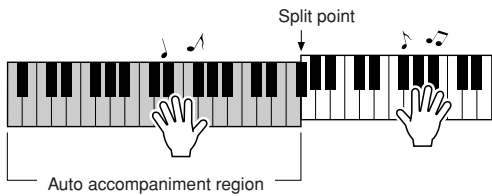

## 6 Press the [START/STOP] button to stop style playback when you’re done.

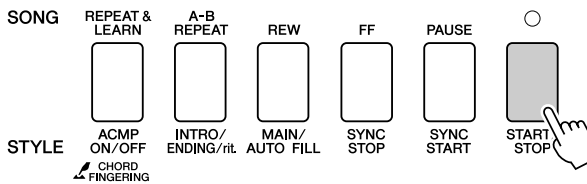

You can switch style “sections” to add variety to the accompaniment. Refer to “Pattern Variation (Sections)” on page 79.

## Styles Are More Fun When You Understand Chords

Chords, created by playing multiple notes at the same time, are the basis for harmonic accompaniment. In this section we'll take a look at sequences of different chords played one after another, or "chord sequences." Since each chord has its own unique "color"—even if it's different fingerings of the same chord—the chords you choose to use in your chord progressions have a huge influence on the overall feel of the music you play.

On page 27 you learned how to play colorful accompaniments using styles. Chord progressions are vital to creating interesting accompaniments, and with a little chord know-how you should be able to take your accompaniments to a new level.

On these pages we'll introduce three easy-to-use chord progressions. Be sure to try them out with the instrument's accompaniment styles. The style will respond to the chord progression you play, effectively creating a complete song.

### ■ Playing the Chord Progressions .....

Play the scores with the left hand.

Before playing the scores follow steps 1 through 3 of "Play Along with a Style" on page 27.

\* The scores provided here are not standard song scores, but rather simplified scores that indicate which notes to play to produce the chord progressions.

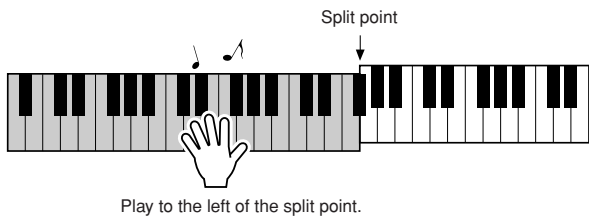

#### Recommended Style 041 Euro Trance

—Dance music with simple chords—

Press the [INTRO/ENDING/rit.] button.

This is a simple-but-effective chord progression. When you play through to the end of the score, start again from the beginning. When you're ready to stop playing press the [INTRO/ENDING/rit.] button and the auto accompaniment function will create a perfect ending.

**Recommended Style**      **148 Piano Boogie**

—3-chord boogie-woogie—

Press the [INTRO/ENDING/rit.] button.

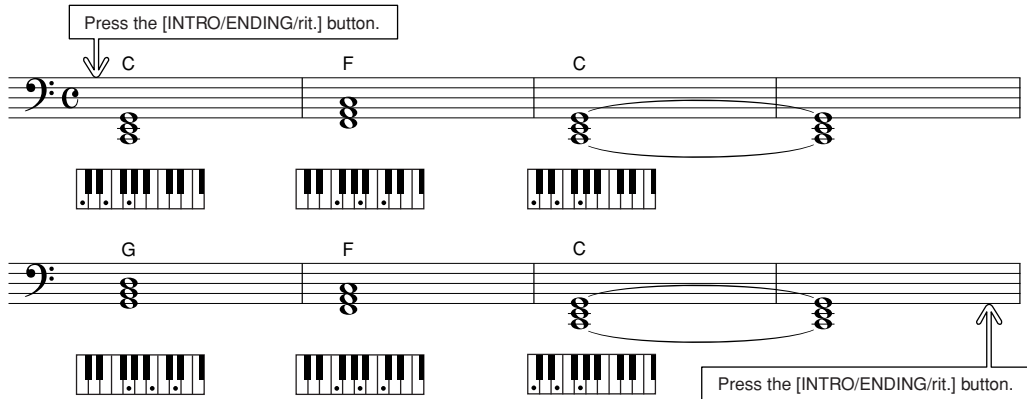

Press the [INTRO/ENDING/rit.] button.

This progression provides varied harmonic backing with just three chords. When you get a feel for the progression in the score, try changing the order of the chords!

**Recommended Style**      **096 Bossa Nova**

—Bossa nova with jazz-style chords—

Press the [INTRO/ENDING/rit.] button.

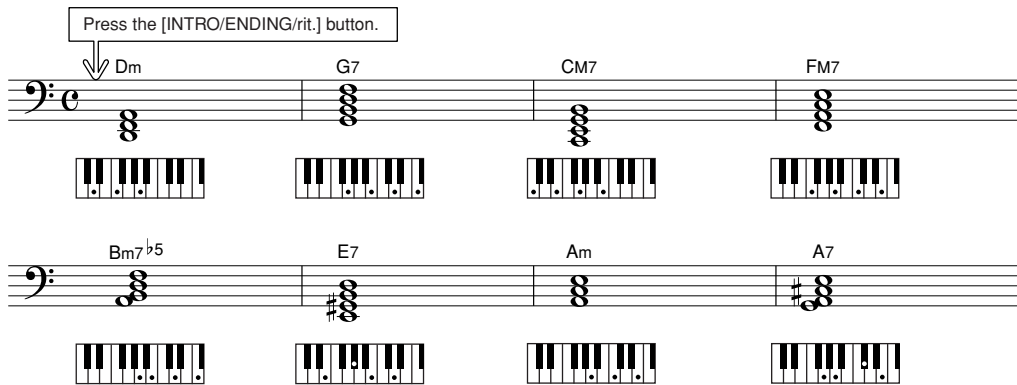

Press the [INTRO/ENDING/rit.] button.

This progression includes jazzy “two-five” (II-V) changes. Try playing it through several times. When you’re ready to stop playing press the [INTRO/ENDING/rit.] button.

# Playing Auto-accompaniment Chords

There are two ways of playing auto-accompaniment chords:

- Easy Chords
- Standard Chords

The instrument will automatically recognize the different chord types. The function is called Multi Fingering.

Press the [ACMP ON/OFF] button to turn auto-accompaniment on (page 27). The keyboard to the left of the split point (default: 054/F#2) becomes the “accompaniment range”. Play the accompaniment chords in this area of the keyboard.

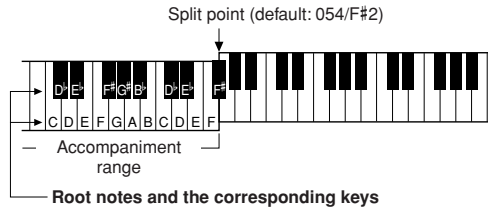

## ■ Easy Chords .....

This method lets you easily play chords in the accompaniment range of the keyboard using only one, two, or three fingers.

<p><b>C</b></p>	<p>• <b>To play a major chord</b> Press the root note of the chord.</p>
<p><b>Cm</b></p>	<p>• <b>To play a minor chord</b> Press the root note together with the nearest black key to the left of it.</p>
<p><b>C7</b></p>	<p>• <b>To play a seventh chord</b> Press the root note together with the nearest white key to the left of it.</p>
<p><b>Cm7</b></p>	<p>• <b>To play a minor seventh chord</b> Press the root note together with the nearest white and black keys to the left of it (three keys altogether).</p>

## ■ Standard Chords .....

This method lets you produce accompaniment by playing chords using normal fingerings in the accompaniment range of the keyboard.

● **How to play Standard Chords [Example for “C” chords]**



\* Notes enclosed in parentheses ( ) are optional; the chords will be recognized without them.

# Using Songs

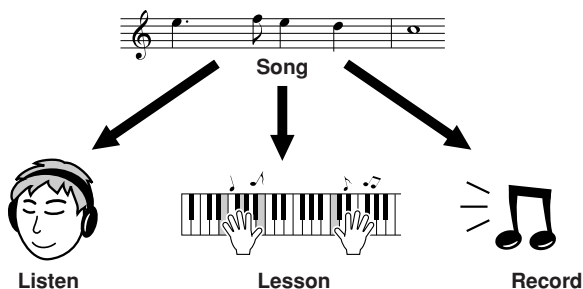

With this instrument the term “song” refers the data that makes up a piece of music. You can simply enjoy listening to a demo song and 29 internal songs, or use them with just about any of the many functions provided—the performance assistant technology feature, lessons, and more. The songs are organized by category.

In this section we’ll learn how to play a demo song and select other songs, and briefly describe the demo song and 29 songs provided.



## Play the Demo song

### 1 Press the [DEMO] button

The demo song will start playing.

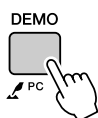

To stop demo play back at any time, press the [DEMO] button or [START/STOP] button.

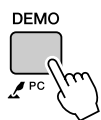

or

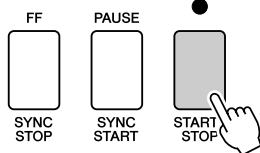



## Select and Listen to a Song

### 1 Press the [SONG] button

The song selection display will appear.  
The currently selected song number and name will be highlighted.

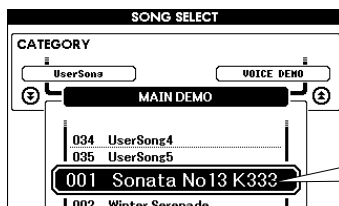

### 2 Select a song.

Select a song after referring to the preset song category list on page 35.  
Use the dial to select the song you want to listen to.

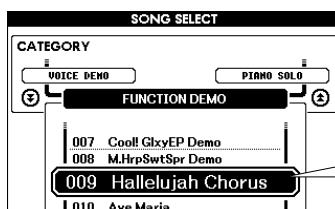
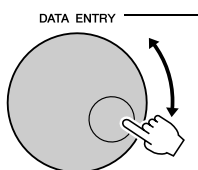

#### NOTE

- You can also play songs you have recorded yourself (User Songs) or songs that have been transferred to the instrument from a computer in the same way that you play the internal songs.

001–030	Built in Songs (See page 35)
031–035	User Songs (Songs you record yourself).
036–	Songs transferred from a computer (pages 107–109) or Songs in a USB flash memory connected to the instrument (page 95)

### 3 Listen to the song.

Press the [START/STOP] button to begin playback of the selected song.  
You can stop playback at any time by pressing the [START/STOP] button again.

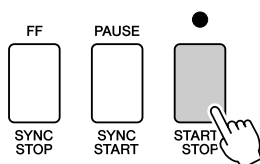

Song start!

## Song Fast Forward, Fast Reverse, and Pause

These are just like the transport controls on a cassette deck or CD player, letting you fast forward [FF], rewind [REW] and pause [PAUSE] playback of the song.

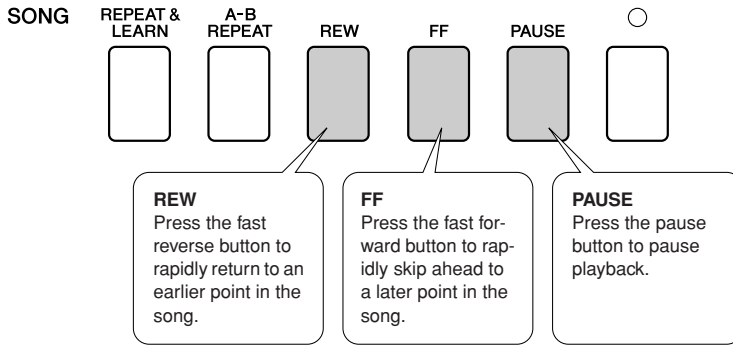

## Change the Song Tempo

You can change the song tempo as required. Press the [TEMPO/TAP] button. The tempo display will appear and you can use the dial, the [+] and [-] buttons, or the [0] to [9] number buttons to set to tempo to anywhere from 5 and 280 quarter-note beats per minute.

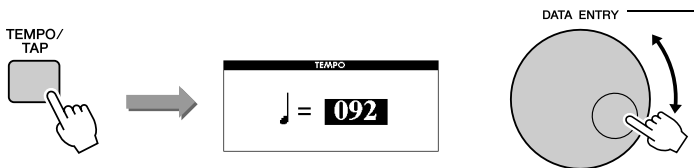

You can return to the original tempo by simultaneously pressing the [+] and [-] buttons. Press the [EXIT] button to return to the MAIN display.

## Song List

These 30 songs include songs that effectively demonstrate the instrument's Easy Song Arranger feature, songs that are ideally suited for use with the performance assistant technology feature, and more. The "Suggested Uses" column provides some ideas as to how the songs can most effectively used.

Category	No.	Name	Suggested Uses
Main Demo	1 <b>CHORD</b>	Mozart Piano Sonata No.13, K333	This song showcases the beautiful piano sound.
	2 <b>CHORD</b>	Winter Serenade	The songs in this category have been created to give you an idea of the advanced capabilities of this instrument. They're great for listening, or for use with the various features.
	3 <b>CHORD</b>	Take off	
Voice Demo	4 <b>CHORD</b>	Live! Grand Demo	
	5 <b>CHORD</b>	Live! Orchestra Demo	
	6 <b>CHORD</b>	Cool! RotorOrgan Demo	
	7 <b>CHORD</b>	Cool! Galaxy Electric Piano Demo	
Function Demo	8 <b>CHORD</b>	ModernHarp & Sweet Soprano Demo	Use these songs to experience some of the instrument's advanced features: song number 9 for the easy song arranger, and songs 10 and 11 for the performance assistant technology feature. The lesson function cannot be used with songs 10 and 11.
	9 <b>CHORD</b>	Hallelujah Chorus	
	10 <b>CHORD</b>	Ave Maria	
Piano Solo	11 <b>CHORD</b>	Nocturne op.9-2	These piano solo pieces are ideally suited for use as lesson songs.
	12	For Elise	
	13	Maple Leaf Rag	
Piano Ensemble	14	Jeanie with the Light Brown Hair	A selection of piano ensemble songs that are also well suited for use as lesson songs.
	15 <b>CHORD</b>	Amazing Grace	
	16 <b>CHORD</b>	Mona Lisa (Jay Livingston and Ray Evans)	
	17	Piano Concerto No.21 2nd mov.	
Piano Accompaniment	18 <b>CHORD</b>	Scarborough Fair	When you need to practice backing (accompaniment) patterns, these are the songs to do it with. This is ability you'll need if you're invited to play with a band. These songs allow you to practice backing parts one hand at a time, which can be the easiest way to master this important skill.
	19 <b>CHORD</b>	Old Folks at Home	
	20 <b>CHORD</b>	Ac Ballad (Against All Odds: Collins 0007403)	
	21 <b>CHORD</b>	Ep Ballad	
	22 <b>CHORD</b>	Boogie Woogie	
	23 <b>CHORD</b>	Rock Piano	
	24 <b>CHORD</b>	Salsa	
	25 <b>CHORD</b>	Country Piano	
	26 <b>CHORD</b>	Gospel R&B	
	27 <b>CHORD</b>	Medium Swing	
28 <b>CHORD</b>	Jazz Waltz		
29 <b>CHORD</b>	Medium Bossa		
30 <b>CHORD</b>	SlowRock (Can't Help Falling In Love: George David Weiss, Hugo Peretti and Luigi Creatore)		

**CHORD** : Includes chord data.

The scores for the internal songs—except for songs 1–11, and song 16, 20 and 30 which is copyrighted, are provided in the Song Book on the CD-ROM. The scores for songs 9–11 are provided in this manual.

Some of the classic and/or traditional songs have been edited for length or for ease in learning, and may not be exactly the same as the original.

## Types of Songs

The following three types of songs can be used by this instrument.

- **Demo Song and Preset songs (the 30 songs built into the instrument)..... Song numbers 001–030.**
- **User Songs (recordings of your own performances) ..... Song numbers 031–035.**
- **External song files (song data transferred from a computer\*) ... Song numbers 036–.**

\* The Accessory CD-ROM includes a selection of 70 MIDI songs. See page 108 for instructions on how to transfer the songs to the instrument.

The chart below shows the basic processes flow for using the preset songs, user songs, and external song files from storage to playback.

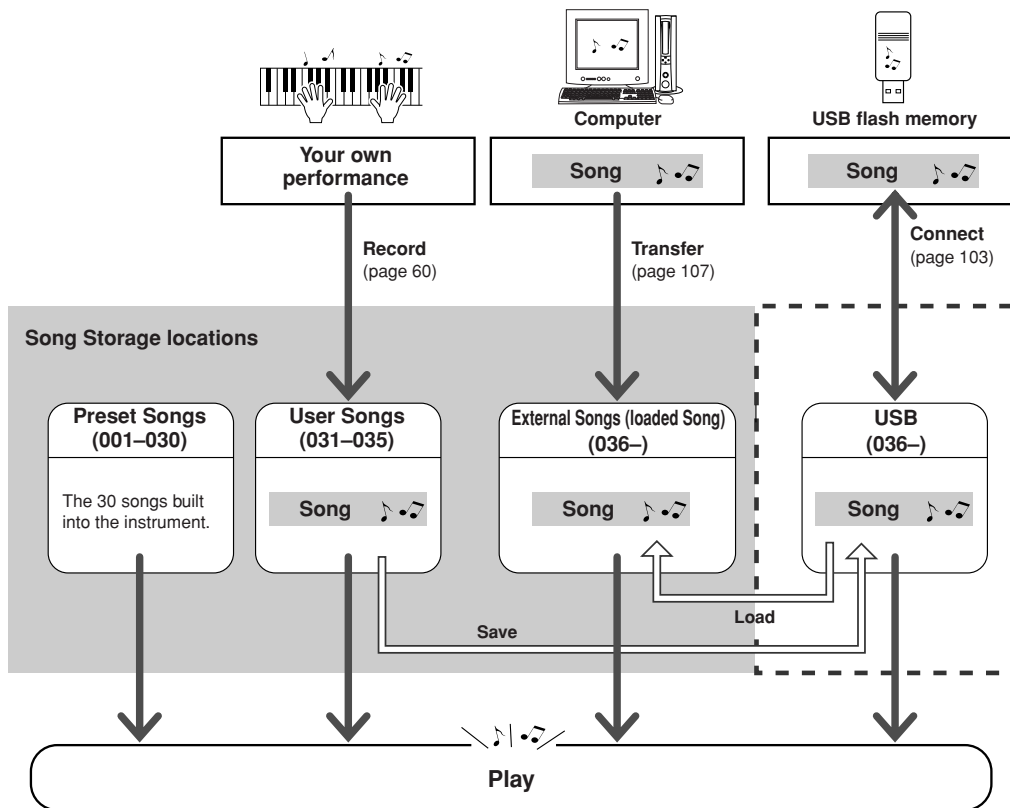

**NOTE**

• User songs cannot produce score display as they are. If you convert a user song file to SMF and save it to USB flash memory, however, it becomes capable of producing score display and can be used with the lesson features.

**NOTE**

• Different flash memory areas are used to store user songs and external song files transferred from a computer. User songs cannot be directly transferred to the flash memory area for the external song, and vice versa.

## Displaying the Song Score

This instrument is capable of display the scores of songs.

Scores are displayed for the 30 internal preset songs as well as songs in SMF format stored in a USB flash memory or the instrument's internal flash memory.

### 1 Select a song.

Follow steps 1 and 2 of the procedure described on page 33.

### 2 Press the [SCORE] button and a single-staff score will appear.

There are two types of score display: single-staff and double-staff.

These are alternately selected each time the [SCORE] button is pressed.

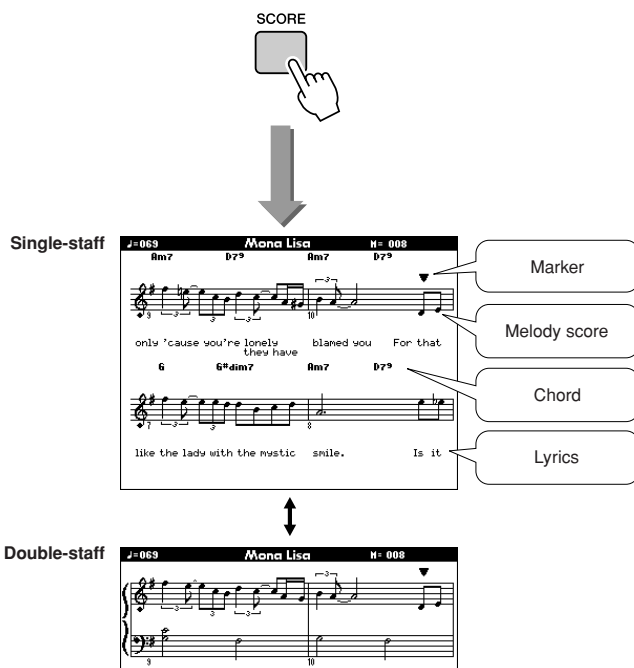

#### NOTE

- The score is created from the recorded song data, and it may not be exactly the same as original score.
- Both chords and lyrics will be shown in single-staff score display of a song that includes chord and lyric data.
- When there are many lyrics they may be displayed in two rows a measure.
- Some lyrics or chords may be abbreviated if the selected song has a lot of lyrics.
- Small notes that are hard to read may be easier to read after you use the quantize function (page 94).

#### NOTE

- No chords or lyrics are shown on the double-staff.

### 3 Press the [START/STOP] button.

The song will begin playing. The triangular will move across the top of the score to indicate the current location.

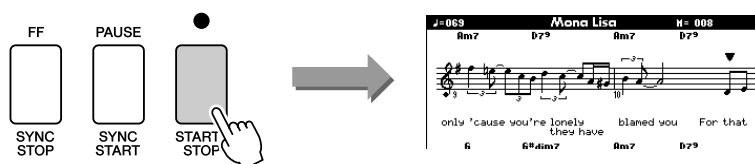

### 4 Press the [EXIT] button to return to the MAIN display.

## Display the Lyrics

If a song contains lyric data, the lyrics can be made to appear on the display. No lyrics will be displayed for a song that contains no lyric data even if the [LYRICS] button is pressed.

### 1 Select a song.

Select a song between 16, 20, and 30 by performing steps 1 and 2 described on page 33.

### 2 Press the [LYRICS] button.

The title, lyricist, and composer of the song will appear on the display.

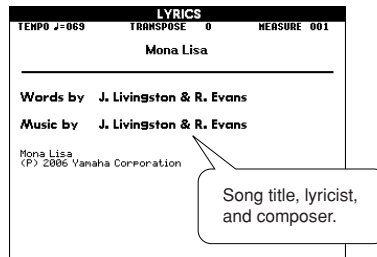

#### NOTE

- Songs downloaded from the Internet or commercially available song files, including XF format files (page 6), are compatible with the lyrics display features as long as they are standard MIDI file format files containing lyric data. Lyrics display may not be possible with some files.

#### NOTE

- If the lyrics display shows garbled characters, try changing the display language (page 16).

### 3 Press the [START/STOP] button.

The song will play back while the lyrics and chords are shown on the display.

The lyrics will be highlighted to show the current location in the song.

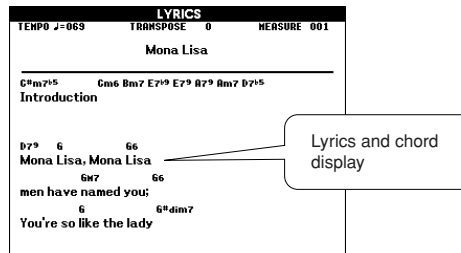
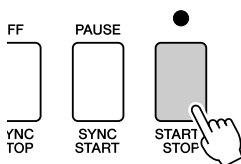

## ■ Preset Songs That Can be Used For Lyrics Display

Number	Name
016	Mona Lisa (Jay Livingston and Ray Evans)
020	Against All Odds (Collins 0007403)
030	Can't Help Falling In Love (George David Weiss, Hugo Peretti and Luigi Creatore)



# The Easy Way to Play Piano

This instrument includes a performance assistant technology feature that lets you play along with a song and sound like a great pianist (even though you might be making lots of mistakes)! In fact, you can play any notes and still sound good! You could even just tap one key and the results would be a beautiful melody. So even if you can't play piano and can't read a note of music, you can have some musical fun.

Performance assistant technology offers four selectable types. Select the type that produces the best results for you.

- **Chord** ..... No matter where or what you play, the result will be musical, well-balanced sound. This type offers the greatest freedom, allowing you to play anything with both your left and right hands.

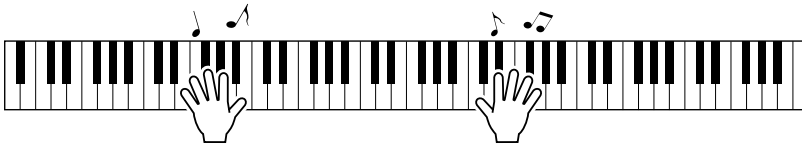

- **Chord/Free** ..... If you can play simple right-hand melodies but have trouble with left-hand chords, this is the type for you. The Chord type applies to only the left-hand section of the keyboard, allowing you to easily play chords to support the melody you are playing with your right hand.

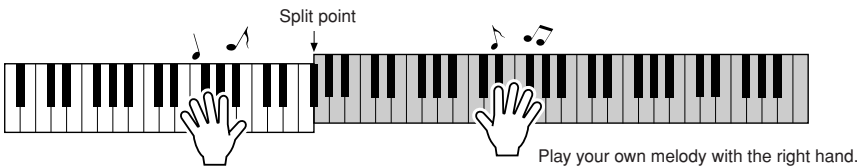

- **Melody** ..... This type lets you play the melody of the selected song by playing any keys with just one finger. Start playing melodies right away, even if you've never played a keyboard instrument before!

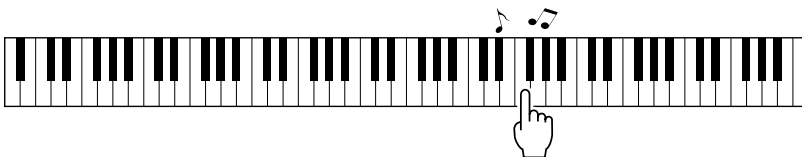

- **Chord/Melody** .... Play the melody of the selected song with one finger on the right-hand section of the keyboard, and play chords on the left-hand section of the keyboard using the Chord type.

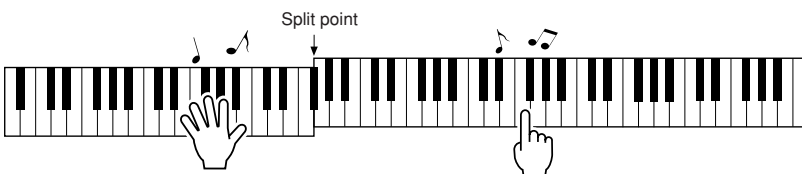

Refer to page 48 for more information on using performance assistant technology to help you play.

## CHORD Type—Play with Both Hands

### 1 Press the [P.A.T. ON/OFF] button.

This turns on the performance assistant technology feature. The currently selected type is shown in the MAIN display when the performance assistant technology feature is on.

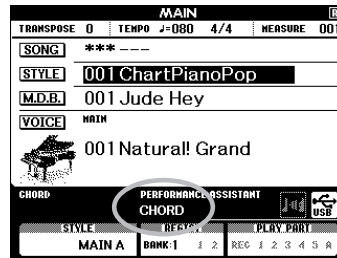
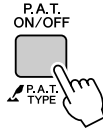

The currently selected type

### 2 Select the CHORD type.

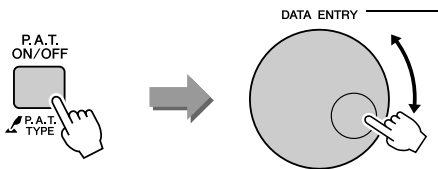

Hold for longer than a second

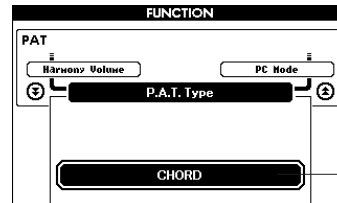

Select Chord

Press and hold the [P.A.T. ON/OFF] button for longer than a second so that the performance assistant technology type appears. Select the Chord type by using the dial.

### 3 Select a song.

Press the [SONG] button, and the Song Select display appears. Select a song by using the dial. For this example try selecting the “010 Ave Maria”.

**NOTE**

• Using Songs (page 32)

When the Chord type is selected, features only available for this song can be seen in the display!

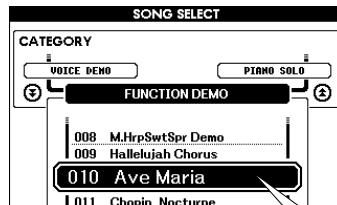
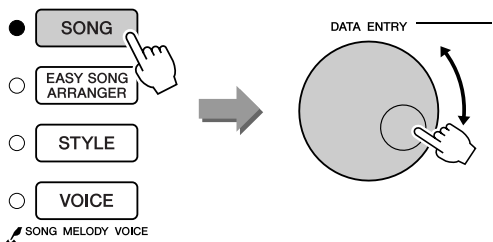

The song displayed here will be played.

#### ● What is a Song?

You know the normal meaning of this word, but in this instrument the term “Song” refers to the data that makes up a complete song. The performance assistant technology features uses the chord and melody data, and should always be used with a song (page 32).



## 4 Press the [START/STOP] button.

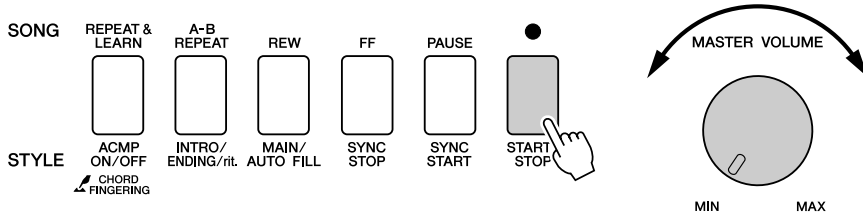

Song playback will begin.

The basic pattern will play repeatedly. Listen to the basic pattern for four measures while getting a feel for the basic pattern, then begin playing yourself from the fifth measure. The keys you should play will be shown in the display.

## 5 Play on the keyboard.

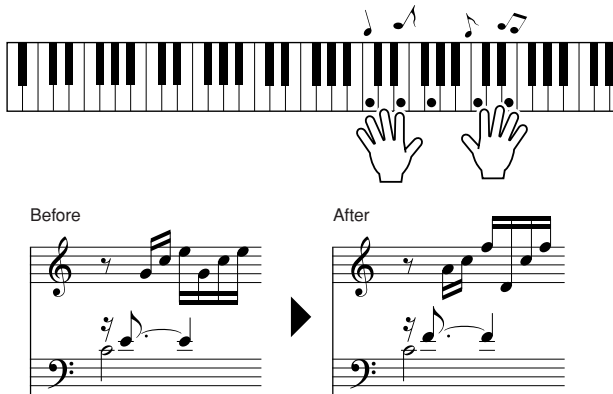

Try playing the score on the left with both hands. You can even play the same keys over and over: C, E, G, C, E, G, C, E. You'll notice that at measure five the notes will come out according to the score on the right. Keep playing, and performance assistant technology Chord type will continue to "correct" the notes that you play.

This is the performance assistant technology Chord type.

You can stop song playback at any time by pressing the [START/STOP] button.

## 6 Press the [P.A.T. ON/OFF] button to turn the performance assistant technology feature off.

"..." will appear on the display where the performance assistant technology type is normally shown.

### NOTE

- The score for Ave Maria is provided on page 122.

## CHORD/FREE Type—Applying the Chord Type to the Left Hand Only

### 1 Press the [P.A.T. ON/OFF] button.

This turns on the performance assistant technology feature. The currently selected type is shown in the MAIN display when the performance assistant technology feature is on.

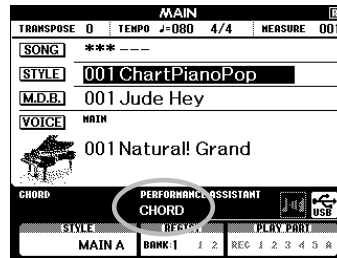
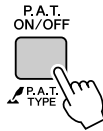

The currently selected type

### 2 Select the CHORD/FREE type.

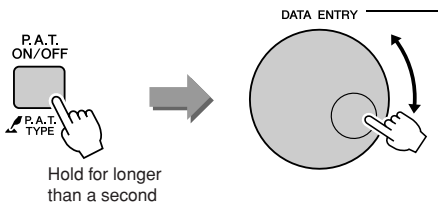

Hold for longer than a second

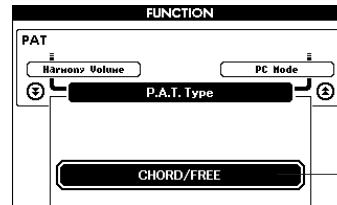

Select Chord/Free

Press and hold the [P.A.T. ON/OFF] button for longer than a second so that the performance assistant technology type appears. Select the Chord/Free type by using the dial.

### 3 Select a song.

Press the [SONG] button, and the Song Select display appears. Select a song by using the dial. For this example try selecting the “011 Nocturne”.

**NOTE**

• Using Songs (page 32)

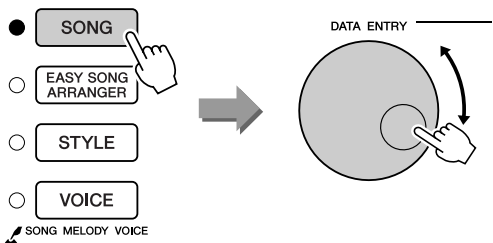

The song displayed here will be played.

## 4 Press the [START/STOP] button.

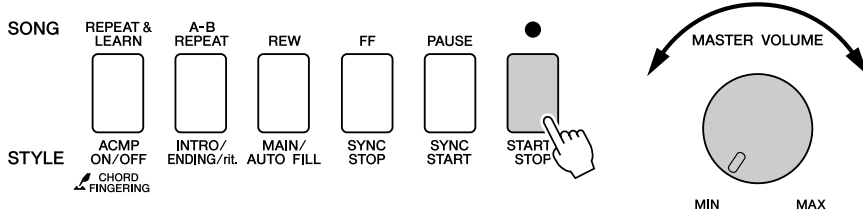

Song playback will begin.

The left-hand keys you should play will be shown on the display.

## 5 Play on the keyboard.

Play to the right of the split point with your right hand, and to the left of the split point with your left hand.

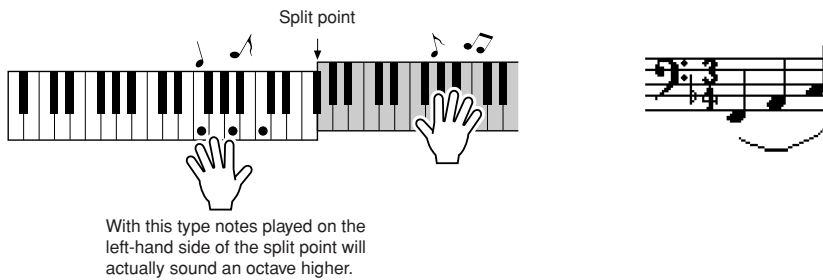

Play the Nocturne melody with your right hand. Continually play an F-A-C arpeggio with your left hand as indicated by the score shown in the display. Although you're repeatedly playing the same notes with your left hand, the actual notes produced will change to match the music. This is the performance assistant technology Chord/Free type.

### NOTE

- The score for Nocturne is provided on page 124.

Press the [SCORE] button if you want to see the score for the right-hand part in the display.

You can stop song playback at any time by pressing the [START/STOP] button.

## 6 Press the [P.A.T. ON/OFF] button to turn the performance assistant technology feature off.

"..." will appear on the display where the performance assistant technology type is normally shown.

# MELODY Type—Play with One Finger

See page 48 for some hints on how to play melodies.

## 1 Press the [P.A.T. ON/OFF] button.

This turns on the performance assistant technology feature. The currently selected type is shown in the MAIN display when the performance assistant technology feature is on.

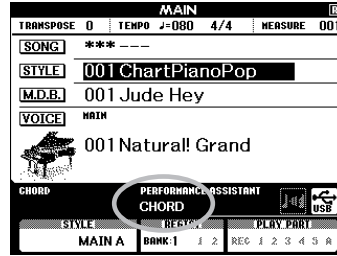
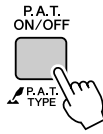

The currently selected type

## 2 Select the MELODY type.

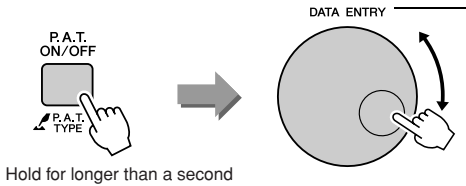

Hold for longer than a second

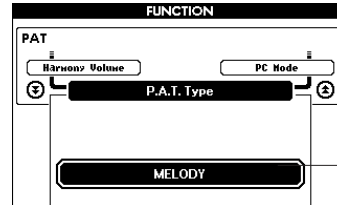

Select Melody

Press and hold the [P.A.T. ON/OFF] button for longer than a second so that the performance assistant technology type appears. Select the Melody type by using the dial.

## 3 Select a song.

Press the [SONG] button, and the Song Select display appears. Select a song by using the dial.

**NOTE**

• Using Songs (page 32)

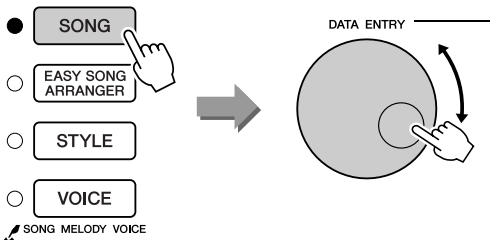

The song displayed here will be played.

## 4 Press the [START/STOP] button.

Song playback will begin.

Because the Melody type has been selected, the song melody will not sound. You can enjoy playing the melody yourself (step 5).

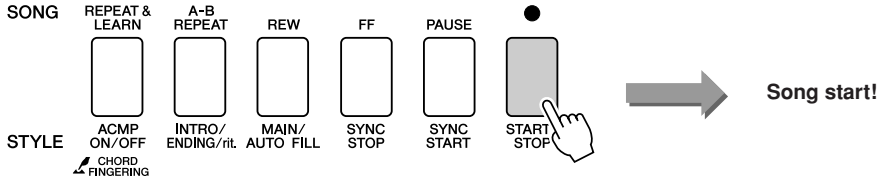

## 5 Play on the keyboard.

To begin, try to feel the rhythm of the song. Then tap a key with one finger of your right hand in time with the music. You can play any key. If you want to play the melody with the melody score, press the [SCORE] button to call up the melody score in the display.

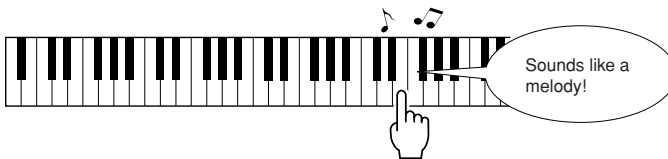

How does it sound? You've played the melody using only one finger thanks to the performance assistant technology Melody type!

You can stop song playback at any time by pressing the [START/STOP] button.

## 6 Press the [P.A.T. ON/OFF] button to turn the performance assistant technology feature off.

"..." will appear on the display where the performance assistant technology type is normally shown.

# CHORD/MELODY—Chord Type with the Left Hand, Melody with the Right

## 1 Press the [P.A.T. ON/OFF] button.

This turns on the performance assistant technology feature. The currently selected type is shown in the MAIN display when the performance assistant technology feature is on.

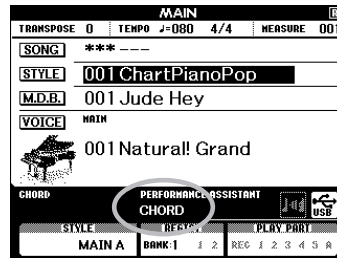
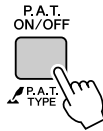

The currently selected type

## 2 Select the CHORD/MELODY type.



Hold for longer than a second

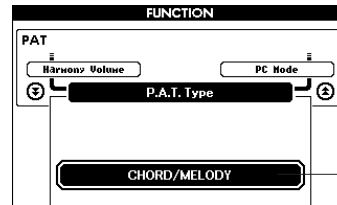

Select Chord/Melody

Press and hold the [P.A.T. ON/OFF] button for longer than a second so that the performance assistant technology type appears. Select the Chord/Melody type by using the dial.

## 3 Select a song.

Press the [SONG] button, and the Song Select display appears. Select a song by using the dial.

**NOTE**

• Using Songs (page 32)

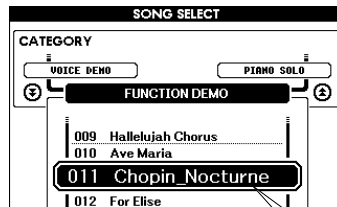
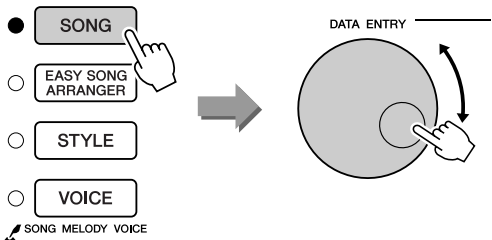

The song displayed here will be played.

## 4 Press the [START/STOP] button.

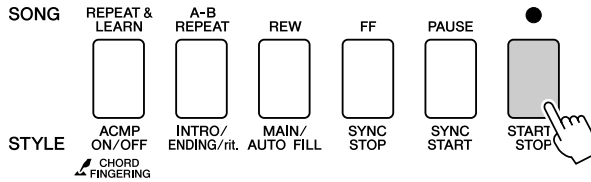

Song playback will begin.

The basic pattern will repeat. Listen to eight measures while memorizing the basic pattern. It's your turn to play the part from the ninth measure.

## 5 Play on the keyboard.

Play to the right of the split point with your right hand, and to the left of the split point with your left hand.

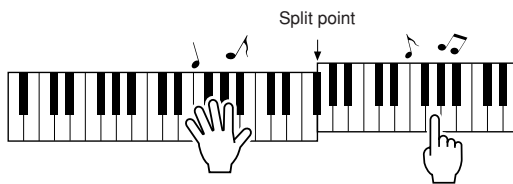

With this type notes played on the left-hand side of the split point will actually sound an octave higher.

Play along with the rhythm of the song melody with your right hand. You can play any keys as long as you're playing to the right of the split point. At the same time play accompaniment-like chords and phrases with your left hand. No matter what you play, you'll produce the song melody with your right hand and beautiful chords and phrases with your left hand.

This is the performance assistant technology Chord/Melody type.

If you want to play the melody with the melody score, press the [SCORE] button to call up the melody score in the display. You can stop song playback at any time by pressing the [START/STOP] button.

## 6 Press the [P.A.T. ON/OFF] button to turn the performance assistant technology feature off.

"..." will appear on the display where the performance assistant technology type is normally shown.

## Use the Performance Assistant to Play Like a Pro!

Here are a few hints for using the Chord type.

If you select Chord/Free or Chord/Melody, the left-hand section of the keyboard becomes the Chord type section, so use these hints on the left-hand section of the keyboard.

To begin, try to feel the rhythm of the song. Then, with your hands spread as shown in the illustration, simply play the keyboard alternately with your left and right hands (any notes will do).

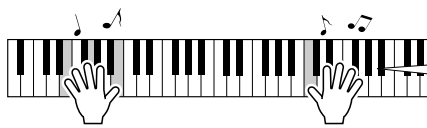

Sounds like you're playing the right notes!

CHORD  
Am7

The chord information included in the song is displayed in the lower area of the MAIN display. You will get even better results if you match your left-hand rhythm to rhythm of the chord indicator in the display.

How does it sound? You'll get acceptable results no matter where you play thanks to the performance assistant technology Chord type!

Next try the three playing methods illustrated below. Different ways of playing produce different results.

- Play with the left and right hands at the same timing—type 1.

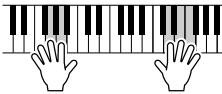

Play 3 notes at once with your right hand.

- Play with the left and right hands at the same timing—type 2.

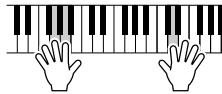

Play 1 note at a time with your right hand (for example: index finger → middle finger → ring finger).

- Play alternately with the left and right hands—type 3.

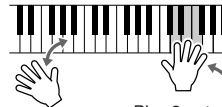

Play 3 notes at once with your right hand.

Once you get a feel for it, try playing chords with your left hand and a melody with your right ... or any other combination.



## Make Use of the Score in the Melody Type.

If you want to play the melody with the correct rhythm, use the onscreen score feature.

### Displaying the Score.

After performing steps 1 to 4 on page 44, press the [SCORE] button. The melody score will appear.

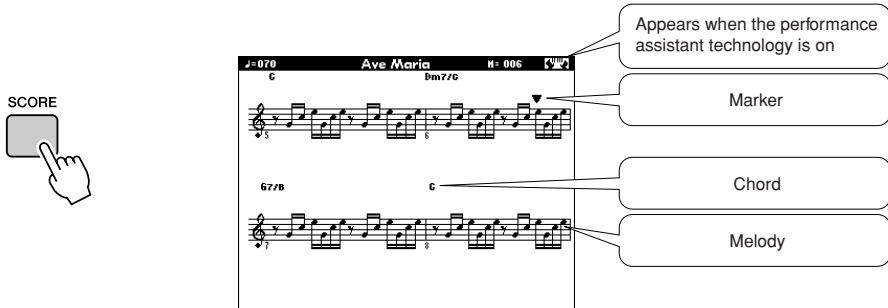

The marker will indicate the current position in the score during playback. If you play a key each time the marker appears above a note in the score you will be able to play the melody with the correct “original” rhythm.

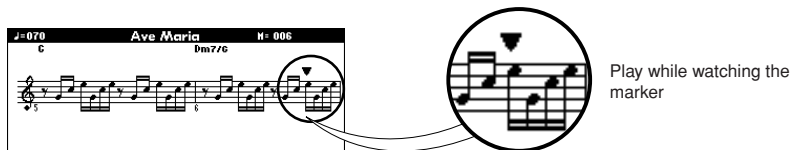

### ● Songs That Can Be Used With the performance assistant technology.

When the Chord type is selected the performance assistant technology can only be used with songs that include chord data. When the Melody type is selected the performance assistant technology will only work with songs that include melody data. In order to find out if a song includes the required data, first select the song and then press the [SCORE] button. If chords appear on the display when you press the [SCORE] button you can use the Chord type or any combination type that includes the Chord type. If melody appear on the display when you press the [SCORE] button you can use the Melody type or any combination type that includes the Melody type.

### ● External Songs and the performance assistant technology.

Songs downloaded from the Internet can also be used with the performance assistant technology as long as they include the required chord and/or melody data.

See page 108 for instructions on how to transfer the songs to the instrument.



# Select a Song For a Lesson

## Yamaha Education Suite

You can select song you like and use it for a left-hand, right-hand, or both-hands lesson. You can also use songs (only SMF format 0/1) transferred to the instrument from a computer. (page 107) During the lesson you can play as slowly as you like, and you can even play wrong notes. Song playback will slow down to a speed you can handle. It's never too late to start learning!

### Lesson Flow:

Select a song from the Piano Solo, Piano Ensemble category!

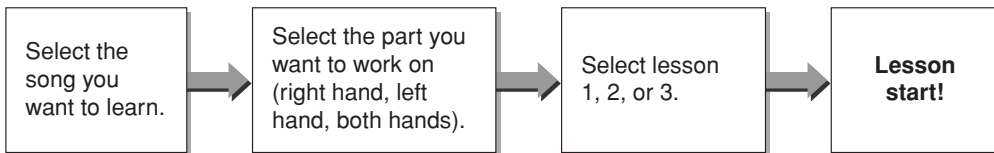

### The practice methods:

- **Lesson 1** ..... Learn to play the correct notes.
- **Lesson 2** ..... Learn to play the correct notes with the correct timing.
- **Lesson 3** ..... Learn to play the correct notes at the correct timing along with the song.

#### **NOTE**

- Song numbers 10 and 11 are function demos for performance assistant. The lesson function cannot be used with them.

## Lesson 1—Waiting

In this lesson, try playing the correct notes. Play the note shown in the display. The song will wait until you play the right note.

### 1 Select a song for your lesson.

Press the [SONG] button, and rotate the dial to select the song you want to use for your lesson. As listed on page 35 there are a variety of song types.

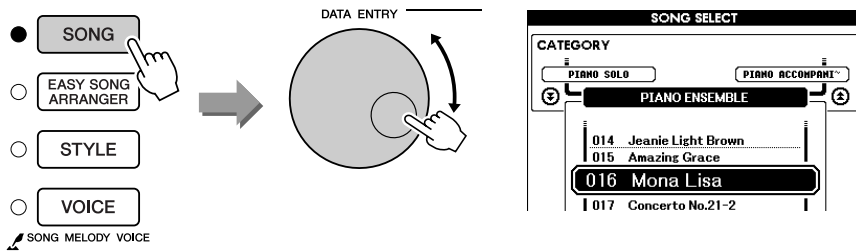

### 2 Press [EXIT] button to return to the MAIN display.

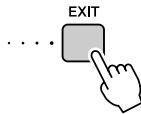

### 3 Select the part you want to practice.

Press the [R] button for a right-hand lesson, [L] button for a left-hand lesson, or press both the [R] and [L] buttons simultaneously for a both-hands lesson. The currently selected part is shown in the upper right corner of the display.

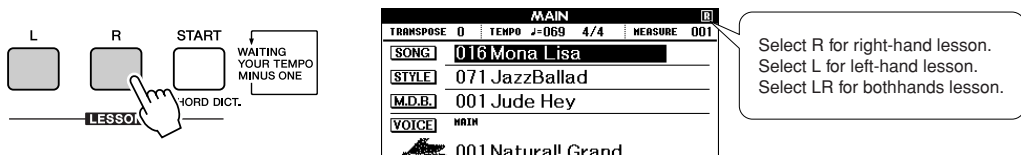

## 4 Start Lesson 1.

Press the LESSON [START] button to select Lesson 1. Each time the LESSON [START] button is pressed the lesson modes are selected in sequence: Lesson 1 → Lesson 2 → Lesson 3 → Off → Lesson 1 ... An explanation of the selected lesson will appear on the display for a few seconds before the lesson begins.

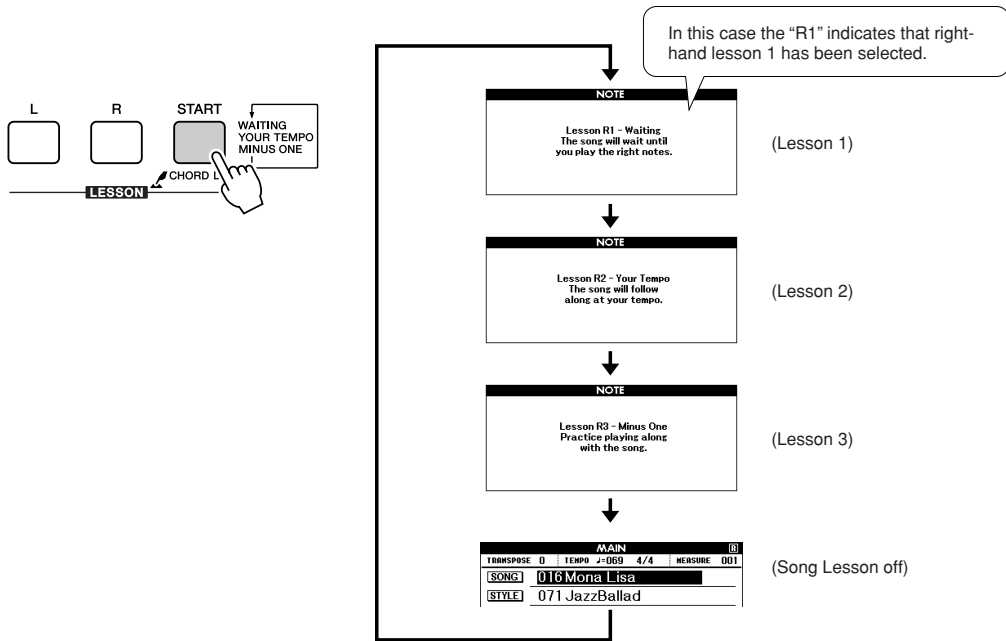

### Song playback will begin automatically when you select Lesson 1.

Play the notes shown in the on-screen score. The next note to be played is indicated by a dot (●) on the appropriate key of the graphic on-screen keyboard. When you play the correct note the marker will move to the next key to be played. Playback will pause and wait for you to play the correct note. The triangular marker (▼) above the score indicates playback progress.

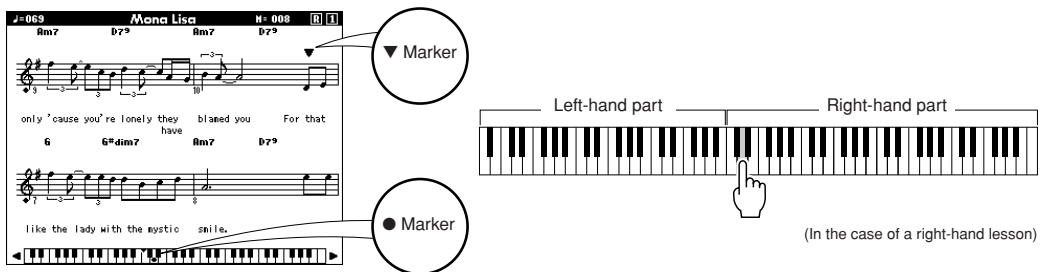

(In the case of a right-hand lesson)

● **Shifting the keyboard left or right.**

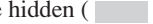
The hidden (  ) areas of the keyboard can be brought into view by pressing the [+] or [-] button.

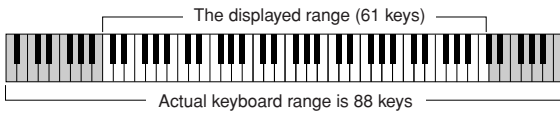

61 keys of the keyboard's range are shown on the display. This instrument actually have 88 keys. In some songs that include very high or low notes, those notes may fall outside the displayed range and may not be shown on the display. In such cases an "over" indicator appear to the left or right of the graphic keyboard. Use the [+] or [-] button to shift the keyboard left or right so you can see the notes (the ● marker will appear on the appropriate key in the display). Notes that actually fall outside the keyboard's range cannot be used in the lesson.

## 5 Stop the Lesson mode

You can stop the Lesson mode at any time by pressing the [START/STOP] button.

Once you've mastered Lesson 1, move on to Lesson 2.

## ■ See How You've Done .....



When the lesson song has played all the way through your performance will be evaluated in 4 levels: OK, Good, Very Good, or Excellent. "Excellent!" is the highest evaluation.

After the evaluation display has appeared, the lesson will start again from the beginning.

**NOTE**

- The evaluation feature can be turned off via the *FUNCTION Grade* item (page 94).

## Lesson 2—Your Tempo

Learn to play the correct notes with the correct timing. Song playback tempo will vary to match the speed you are playing at. The song will slow down when you play wrong notes, so you can learn at your own pace.

**1** Select the song and part you want to practice (steps 1 and 3 on page 51).

**2** Start Lesson 2.

Each time the LESSON [START] button is pressed the lesson modes are selected in sequence: Lesson 1 → Lesson 2 → Lesson 3 → Off → Lesson 1 ...

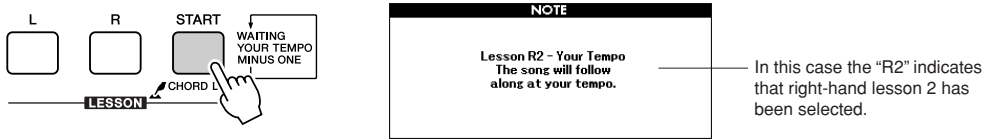

**Song playback will begin automatically when Lesson 2 is selected.**

The triangular marker will appear in the score display, and will move to indicate the current note in the song. Try to play the notes at the correct timing. As you learn to play the right notes at the right timing the tempo will increase until eventually you'll be playing at the song's original tempo.

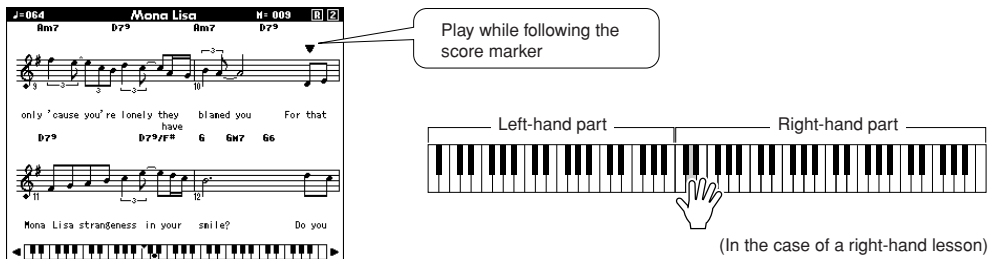

**3** Stop the Lesson mode.

You can stop the Lesson mode at any time by pressing the [START/STOP] button.

Once you've mastered Lesson 2, move on to Lesson 3.

## Lesson 3—Minus One

Here's where you can perfect your technique. The song will play at the normal tempo, minus the part you have chosen to play. Play along while listening to the song.

**1** Select the song and part you want to practice (steps 1 and 3 on page 51).

**2** Start Lesson 3.

Each time the LESSON [START] button is pressed the lesson modes are selected in sequence: Lesson 1 → Lesson 2 → Lesson 3 → Off → Lesson 1 ...

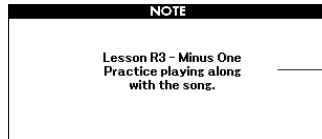
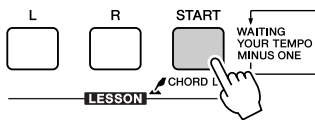

In this case the "R3" indicates that right-hand lesson 3 has been selected.

**Song playback will begin automatically when Lesson 3 is selected.**

Play along while listening to the song. The score marker and keyboard marker in the display will indicate the notes to play.

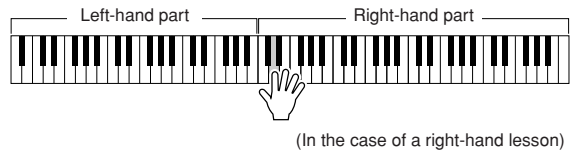

**3** Stop the Lesson mode.

You can stop the Lesson mode at any time by pressing the [START/STOP] button.

## Practice Makes Perfect—Repeat and Learn

Use this feature when you want to start again just ahead of a section on which you made a mistake, or to repeatedly practice a section you find difficult.

### Press the [REPEAT & LEARN] button during a lesson.

The song location will move back four measures from the point at which you pressed the button, and playback will begin after a one-measure count-in. Playback will continue up to the point at which you pressed the [REPEAT & LEARN] button, and then jump back four measures and begin again after a count-in. This process will repeat, so all you have to do is press the [REPEAT & LEARN] button when you make a mistake in order to repeat practice of that section until you get it right

**NOTE**

- You can change the number of measures the Repeat and learn function jumps back by pressing a number button [1]–[9] during repeat playback.

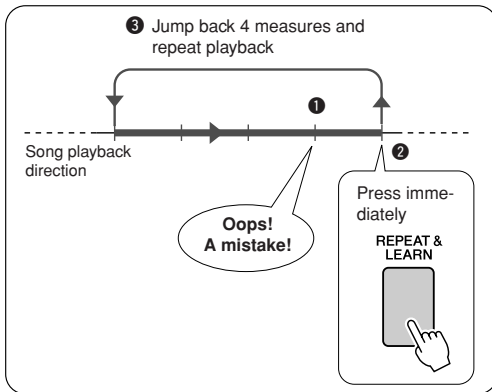
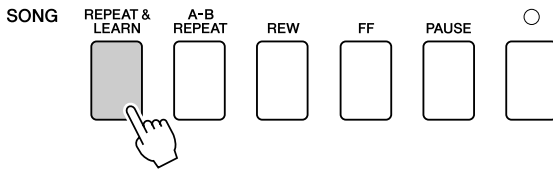





# Play Using the Music Database

You want to play music in your favorite style, but you're not sure how to select the best voice and style for the type of music you want to play ... simply select the appropriate style from the Music Database. The panel settings will automatically be adjusted for the ideal combination of sounds and style!

## 1 Press the [MUSIC DATABASE] button.

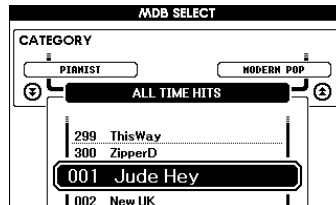

A Music Database list will appear in the display.

## 2 Select a Music Database.

Referring to the list on the panel or Music Database List on page 135 of the manual, use the dial to select a music database. Select one that matches the image of the song you intend to play. For this example select the “158 Patrol”.

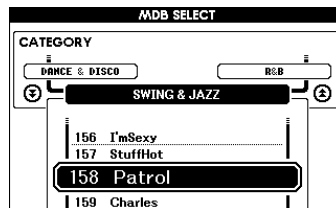
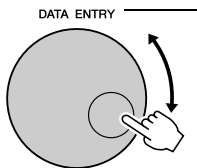

### NOTE

• Music Database (MDB) files transferred from a computer or stored on a USB flash memory device connected to the instrument can be selected and used in the same way as the internal Music Databases (MDB numbers 301–). File transfer instructions are provided on page 107.

## 3 Play the chords with your left hand and melody with your right.

The jazz style will start playing when you play a left-hand chord to the left of the split point (page 27). Refer to pages 29–31 for information about playing chords.

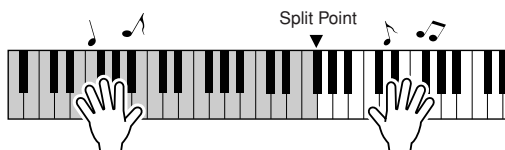

If you press the [EXIT] button to return to the MAIN display at this point you can check the assigned voice and style.

## 4 Press the [START/STOP] button to stop playback.



# Change a Song's Style

In addition to each song's default style, you can select any other style to play the song with the Easy Song Arranger feature. This means that you can play a song that is normally a ballad, for example, as a bossa nova, as a hip-hop tune, etc. You can create totally different arrangements by changing the style with which a song is played.

You can also change the song's melody voice and the keyboard voice for a complete change of image.

## Try Out the Easy Song Arranger

You can try out the Easy Song Arranger feature using the internal Hallelujah Chorus song.

Press the [SONG] button and use the dial to select "009 Hallelujah Chorus." Press the [START/STOP] button begin playback of the song. An explanation of the Easy Song Arranger feature will appear on the display.

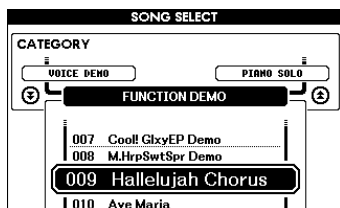

As the song progresses the styles will change, changing the overall image of the song.

Keep in mind that you can enjoy using Easy Song Arranger with other songs as well—any songs that include chord data.

### NOTE

- The score for Hallelujah Chorus is provided on page 120.

## Using the Easy Song Arranger

### 1 Press the [EASY SONG ARRANGER] button.

The Song Select display will appear. The currently selected song name and number will be highlighted.

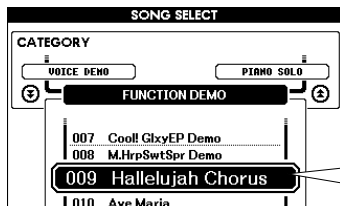
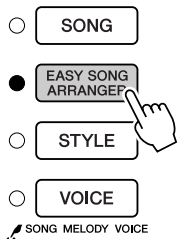

The currently selected song number and name are displayed here.

### 2 Select a Song.

Use the dial to select the song you want to arrange.

### 3 Listen to the song.

Press the [START/STOP] button to begin playback of the song. Move on to the next step while the song is playing.

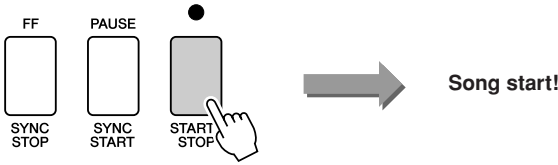

**NOTE**

• When playing song numbers 010, 011, and 020 to 030 while using the Easy Song Arranger, melody tracks will be automatically muted and no melody will sound. In order to hear the melody tracks you will need to press the SONG MEMORY buttons [3] to [5].

### 4 Press the [EASY SONG ARRANGER] button.

The Style Select display will appear. The currently selected style name and number will be highlighted.

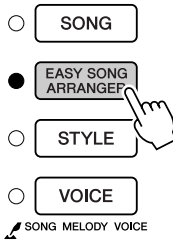

The currently selected style number and name are displayed here.

### 5 Select a style.

Rotate the dial and listen to how the song sounds with different styles. As you select different styles the song will remain the same while only the styles change.

**NOTE**

• Because the Easy Song Arranger uses song data you can't specify chords by playing in the accompaniment range of the keyboard. The [ACMP ON/OFF] button will not function.  
• If the time signature of the song and style are different, the time signature of the song will be used.

### 6 Select a voice part.

If you press and hold the [VOICE] button for longer than a second a voice list will appear. The Melody R and Melody L displays will be selected alternately each time you press the [VOICE] button.



Hold for longer than a second

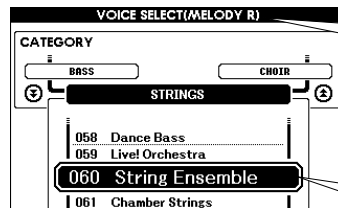

The Melody R and Melody L displays will be selected alternately each time you press the [VOICE] button.

The currently selected melody voice will be displayed.

### 7 Select a voice you want to play as a song melody.

Use the dial to change the melody voice. As you select different melody voices the song will remain the same while only the melody voice changes.

**NOTE**

• If you press the [INTRO/ENDING/rit.] button during style playback, the style will stop but the song will continue playing. Use the [START/STOP] button to stop playback completely.



# Record Your Own Performance

You can record up to 5 of your own performances and save them as user songs 031 through 035. Once your performances have been saved as user songs they can be played in the same way as the internal songs. User songs can also be saved to a USB flash memory device, as described on page 99.

## ■ Recordable Data

5 melody tracks and 1 Style (chord) track can be recorded. To record your own performance, first use the SONG MEMORY [1]–[5] and [A] buttons to specify the track(s) you want to record on.

### ● SONG MEMORY (Track) [1]–[5]

Record the melody parts.

### ● SONG MEMORY (Track) [A]

Records the style pattern and chord parts.

#### **NOTE**

- Up to approximately 30,000 notes can be recorded for the five user songs if you record only to the melody tracks.
- User songs are saved as SMF (Standard MIDI File) format 0 files. Refer to page 107 for information on SMF files.

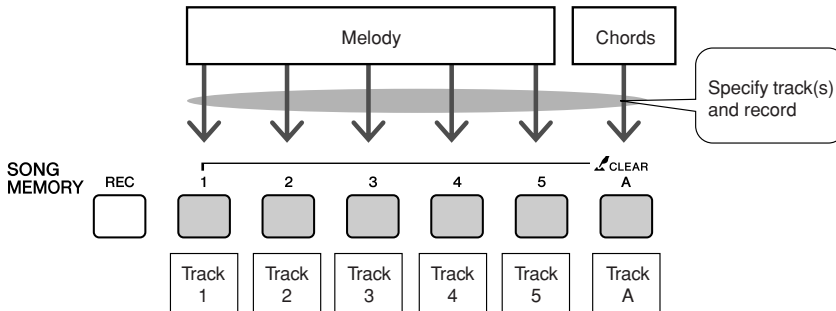

## ■ Track Mute

This instrument allows you to choose whether recorded tracks will play back while you are recording or playing back other tracks (page 89).

## Recording Procedure

- 1** From the MAIN display press the [SONG] button, then use the dial to select the user song number (031–035) you want to record to.

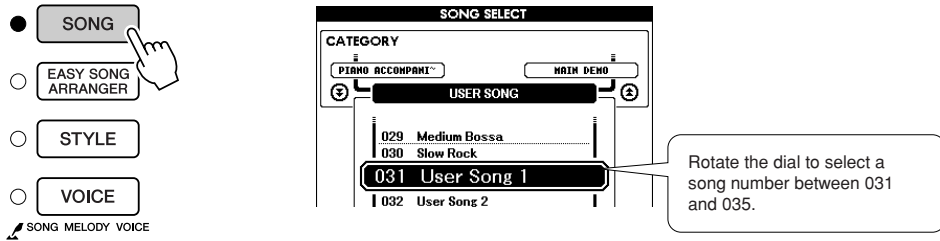

- 2** Select the track(s) you want to record to and confirm your selection on the display.

### ◆ Record a Melody Track and the Accompaniment Track Together

Press the melody track button [1]–[5] you want to record to while holding the [REC] button.

Next, press the [A] button while holding the [REC] button.

The selected tracks will be highlighted in the display.

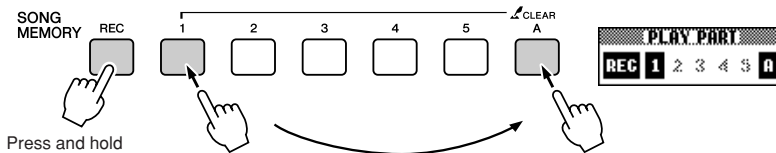

### ⚠ CAUTION

- If you record to track that contains previously-recorded data the previous data will be overwritten and lost.

### NOTE

- Style accompaniment is automatically turned on when you select the style track [A] for recording.
- Style accompaniment cannot be turned on or off while recording is in progress.

### ◆ Record a Melody track

Press the melody track button [1]–[5] you want to record to while holding the [REC] button. Select button [1]–[3] if you want to record a dual voice. Split voices cannot be recorded.

The selected track will be highlighted in the display.

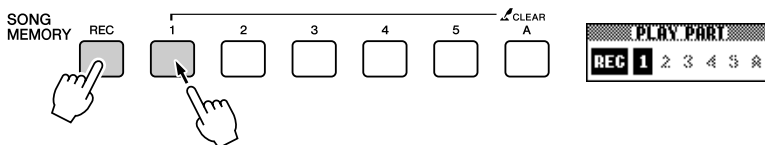

### NOTE

- If style accompaniment is on and track [A] has not yet been recorded, the style track [A] will automatically be selected for recording when a melody track is selected. If you only want to record a melody track, be sure to turn the style track [A] off.

To cancel recording to a selected track, press that track button a second time. Style accompaniment cannot be turned on or off while recording is in progress.

### 3 Recording will start when you play on the keyboard.

You can also start recording by pressing the [START/STOP] button. The current measure will be shown on the display during recording.

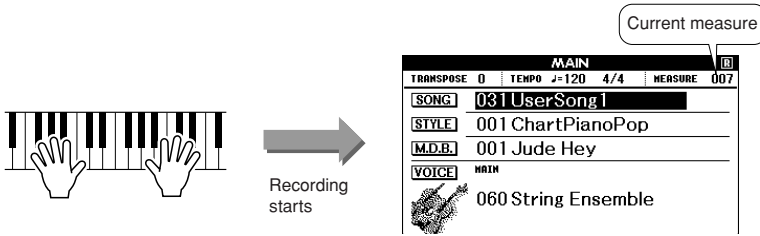

**NOTE**

- If the memory becomes full during recording a warning message will appear and recording will stop automatically. Use the *song clear* or *track clear* (page 63) function to delete unwanted data and make more room available for recording, then do the recording again.

### 4 Stop recording by pressing the [START/STOP] or [REC] button.

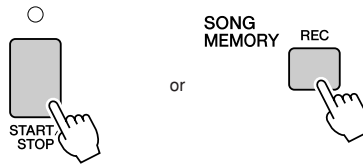

**NOTE**

- If you press the [INTRO/ENDING/rit.] button while recording a style track, an appropriate ending pattern will play and then recording will stop.

When recording stops the current measure number will return to 001 and the recorded track numbers in the display will be shown in a box border.

### 5 Save the song.

When recording is stopped a message asking if you want to save the song will appear. Press the [+ / YES] button to save the song, or the [- / NO] button if you don't want to save the song. If saved, the song will be stored as a MIDI file in song number 031–035.

**CAUTION**

- The recorded Song data will be lost if you turn the power to the instrument off without executing the Save operation.

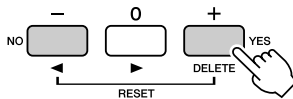

If you press the [- / NO] button in response to the confirmation message the song will not be saved as a MIDI file but will remain in the instrument's memory until the power is turned off, so you have the option of converting the song to a MIDI file and saving it later. To do this press and hold the [REC] button until the save confirmation message appears, then press the [+ / YES] button.

### ● To Record Other Tracks

Repeat steps 2 through 5 to record any of the remaining tracks. By selecting an unrecorded track—SONG MEMORY buttons [1]–[5], [A]—you can record the new track while listening to previously recorded tracks (the border around the track number will appear in the display). You can also mute previously recorded tracks (the border around the track number disappears in the display) while recording new tracks.

### ● To Re-record a Track

Simple select the track you want to re-record for recording in the normal way.

The new material will overwrite the previous data.

## 6 When the recording is done ...

### ◆ To Play Back a User Song

User songs are played back in the same way as regular songs (page 32).

- 1 Press the [SONG] button from the MAIN display.
- 2 The current song number/name will be highlighted—use the dial to select the user song (031–035) you want to play.
- 3 Press the [START/STOP] button to start playback.

### ◆ To save a User Song to USB flash memory → page 99.

### ● Data that cannot be recorded

- Split voice
- The following items are recorded at the beginning of the track. Changes made during the song will not be recorded.  
Time signature, Style number, Style volume

## Song Clear—Deleting User Songs

This function clears an entire user song (all tracks).

### NOTE

- If you only want to clear a specific track from a user song use the Track Clear function.

**1** From the SONG SELECT display select the user song (031–035) you want to clear.

**2** Press and hold the SONG MEMORY [1] button for longer than a second while holding the SONG MEMORY [A] button.

A confirmation message will appear on the display.

You can cancel the clear operation by pressing the [-] button.

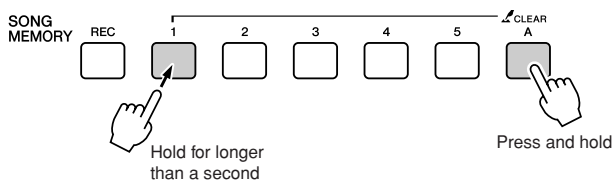

- 3 Press the [+]** button to clear the song.  
The clear-in-progress message will appear briefly on the display while the song is being cleared.

## Track Clear—Deleting a Specified Track from a User Song

This function lets you delete a specified track from a user song.

- 1 From the SONG SELECT display select the user song (031–035) you want to clear.**
- 2 Press and hold the SONG MEMORY track button ([1]–[5], [A]) corresponding to the track you want to clear for longer than a second.**

A confirmation message will appear on the display.  
You can cancel the clear operation by pressing the [-] button.

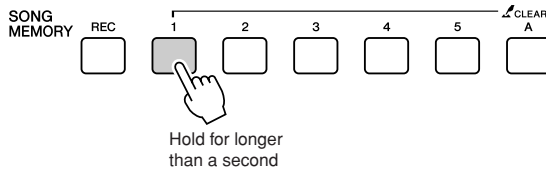

- 3 Press the [+]** button to clear the track.  
The clear-in-progress message will appear briefly on the display while the track is being cleared.





# Backup and Initialization

## Backup

The following settings are always backed up, and are maintained even when the power is turned off. If you want to initialize the settings, use the Initialize operation as explained below.

### ● The Backup Parameters

- Registration Memory
- FUNCTION Settings: Tuning, Split Point, Touch Sensitivity, Style Volume, Song Volume, Metronome Volume, Grade, Demo Cancel, Language Selection, Sustain, Sound Type, Chord Fingering

## Initialization

This function erases all backup data in the instrument's flash memory and restores the initial default settings. The following initialization procedures are provided.

### ■ Backup Clear .....

To clear data backed up to the internal flash memory—panel user setting, registration memory—turn the power on by pressing the power switch while holding the highest white key on the keyboard. The backed up data will be erased and the default values restored.

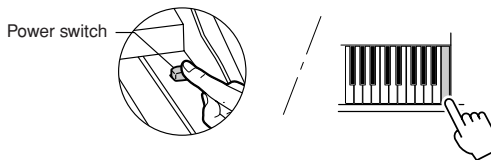

### ■ Flash Clear .....

To clear User Songs as well as Song, Style, and Music Database files that have been transferred to the internal flash memory from a computer, turn the power on by pressing the power switch while simultaneously holding the highest white key on the keyboard and the three highest black keys.

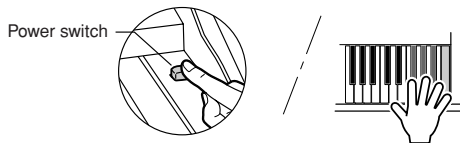

#### **CAUTION**

- When you execute the Flash Clear operation, data you have purchased will also be cleared. Be sure to save data you want to keep to a computer.



# Basic Operation

## Basic Operation

Overall control is based on the following simple operations.

- 1** Press a button to select a basic function.
- 2** Use the dial to select an item or value.
- 3** Start a function.

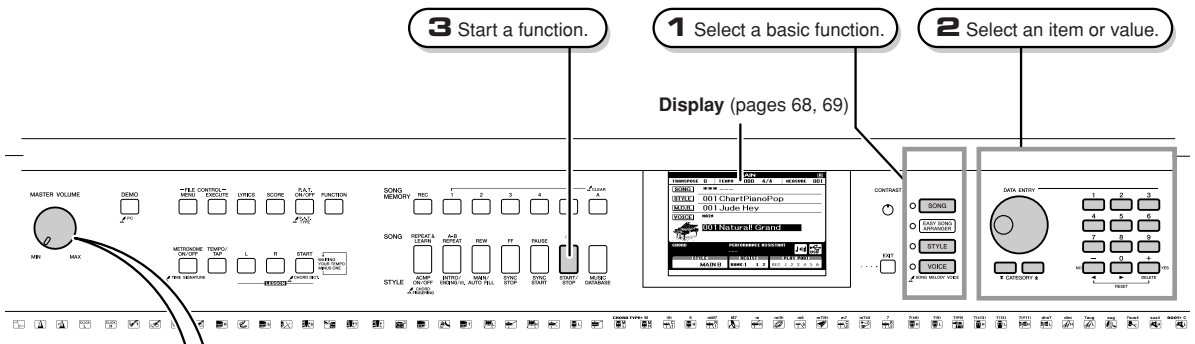

**● Volume Adjustment**  
 Adjusts the volume of the sound heard via the instrument's speakers or a pair of headphones plugged into the PHONES jack.

Rotate counter-clockwise to lower the volume.  
 Rotate clockwise to increase the volume.

MIN MAX

## 1 Press a button to select a basic function.

- SONG** — Select a song you want to listen to or a song you want to use for a lesson.
  - EASY SONG ARRANGER**
  - STYLE** — Select an auto-accompaniment style.
  - VOICE** — Select a voice you want to play on the keyboard.
- SONG MELODY VOICE**

## 2 Use the dial to select an item or value

When you select a basic function, the item corresponding to that function will be listed in the display. You can then use the dial or the number buttons [0]–[9] to select the desired item.

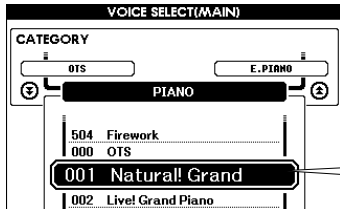

The currently selected item is highlighted in the display. In this example the [VOICE] button has been pressed.

## Changing Values

### Dial

Rotate the dial clockwise to increase the value of the selected item, or counterclockwise to decrease its value. Rotate the dial continuously to continuously increase or decrease the value.

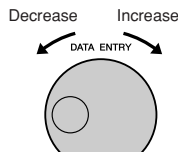

### [+] and [-] Buttons

Press the [+] button briefly to increment the value by 1, or press the [-] button briefly to decrement the value by 1. Press and hold either button to continuously increment or decrement the value in the corresponding direction.

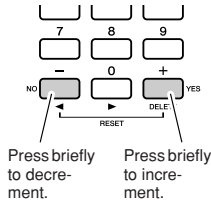

### Number Buttons [0]–[9]

The number buttons can be used to directly enter a song number or parameter value. Hundreds or tens digits that are “0” can be omitted (see below).

**Example: Song number “003” can be entered in three ways.**

- [0] → [0] → [3]
- [0] → [3]
- [3]

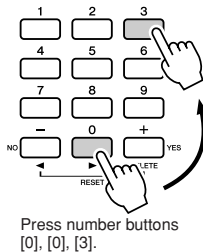

### CATEGORY [▲] and [▼] buttons

When selecting a song, style, or voice, you can use these buttons to jump to the first item in the next or previous category.

Jump to the first item in the next or previous category.

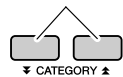

The CATEGORY [▲] and [▼] buttons are useful for selecting categorized items, as in the example below.

### Example: VOICE SELECT Display

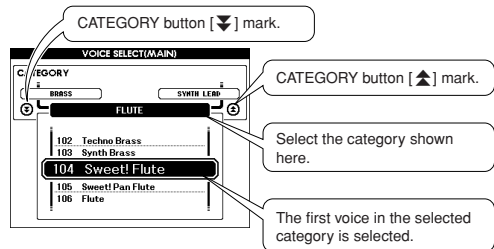

In a display in which a category appears, selection is easy if you first use the CATEGORY [▲] and [▼] buttons to select the category containing the desired item, then use the dial or [+] and [-] buttons to select the item. This can be particularly handy when you have to select from a large number of voices.

In most procedures described throughout this owner's manual the dial is recommended for selection simply because it is the easiest and most intuitive selection method. Please note however, that most items or values that can be selected using the dial can also be selected using the [+] and [-] buttons.

## 3 Start a function.



This is the [START/STOP] button. Press the [START/STOP] button after pressing the [SONG] or [STYLE] button to start playback of the selected song or style (rhythm).

## The Displays

### ● Display Names

All operations are carried out while watching the display. A number of display types are provided for different modes and functions. The name of the current display appears at the top of the display.

### ● MAIN Display

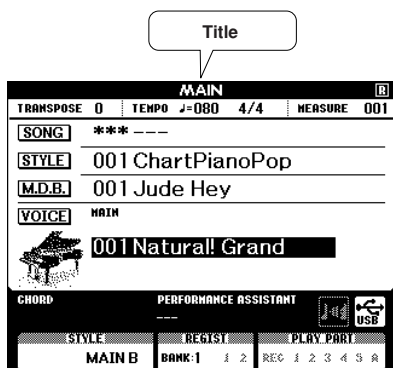

### To Return To the MAIN Display

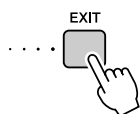

Most basic operations are carried out from the instrument's MAIN display.

You can return to the MAIN display from any other display by pressing the [EXIT] button near the lower right corner of the display panel.

### ● FUNCTION Display (page 92)

The FUNCTION display provides access to 49 utility functions.

The FUNCTION display appears when the [FUNCTION] button is pressed. In the FUNCTION display you can use the CATEGORY [▲] and [▼] buttons (page 67) to select 49 different groups of functions. Press the CATEGORY button(s) as many times as necessary until the required function appears. You can then use the dial, the [+] and [-] buttons, or the number [0]–[9] buttons to adjust the value of the function as required.

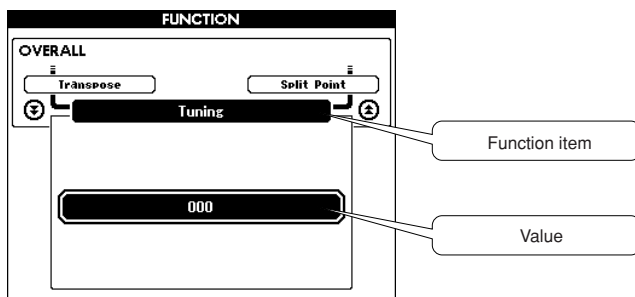

### The "Press & Hold" Symbol

The "  " symbol that appears next to some buttons indicates that the button can be pressed and held for longer than a second to call up a related function. This provides convenient direct access to a range of functions.

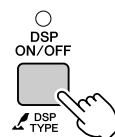

# MAIN Display Items

The MAIN display shows all of the current basic settings: song, style, voice. It also includes a range of indicators that show the on/off status of a range of functions.

\* Adjust the LCD CONTRAST control on the panel of the instrument for optimum display legibility.

CONTRAST 

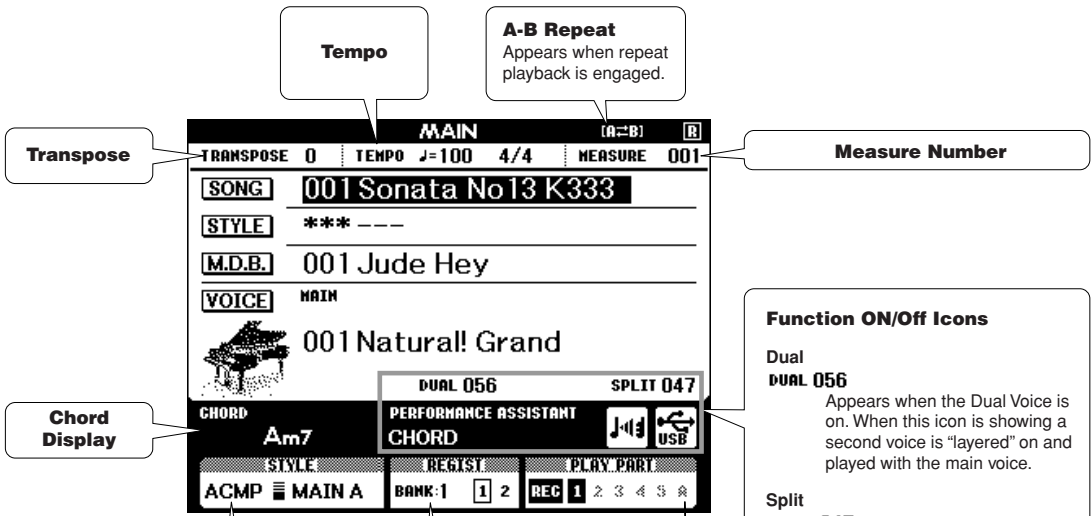

**Style (Auto-accompaniment) Status (page 27)**

**STYLE**  
ACMP MAIN A

**ACMP** Appears when the [ACMP ON/OFF] button is pressed to turn accompaniment on after selecting a style. When showing the keyboard range to the left of the split point is used for accompaniment chord recognition.

 Appears when the synchro-stop function is engaged.

**MAIN A** The style pattern name.

**Registration Memory Status (page 90)**

**REGIST**  
BANK: 1 1 2

**BANK: 1** Shows the selected bank number.

**1 2** Shows the memory numbers that contain data. A border appears around the selected number.

**Song Track Status (pages 60, 89)**

**PLAY PART**  
REC 1 2 3 4 5 6

**REC** Highlighted during user song recording.

**1 2 3 4 5 6**  
The track(s) selected for recording are highlighted during user-song recording. Only tracks that contain data are displayed. A border appears around a selected track that is being played. No border appears around a Muted track.

**Function ON/Off Icons**

**Dual DUAL 056**  
Appears when the Dual Voice is on. When this icon is showing a second voice is "layered" on and played with the main voice.

**Split SPLIT 047**  
Appears when the Split Voice is on. When this icon is showing different voices can be played to the left and right of the keyboard split point.

**Performance assistant technology PERFORMANCE ASSISTANT CHORD**  
Appears when the performance assistant technology is on.

 **Harmony**  
Appears when Harmony is on. When this icon is showing harmony notes will be added to the main voice.

 **File Control**  
When this icon is showing you can control file operations.



# Play with a Variety of Effects

## Adding Harmony

This feature adds harmony notes to the main voice.

### 1 Press the [HARMONY ON/OFF] button to turn Harmony feature on.

To turn Harmony off, press the [HARMONY ON/OFF] button again.

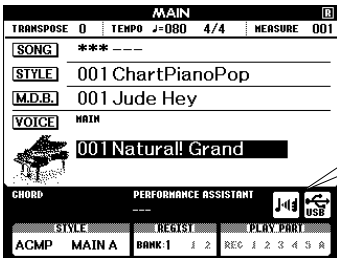
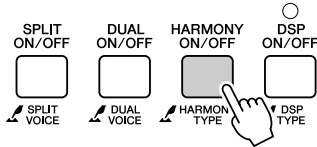

When harmony is on the harmony icon will appear in the display.

**NOTE**  
• When you press the [HARMONY ON/OFF] button to turn this feature on, the appropriate harmony type for the currently selected main voice is automatically selected.

### 2 Press and hold the [HARMONY ON/OFF] button for longer than a second.

The currently selected harmony type will be displayed.

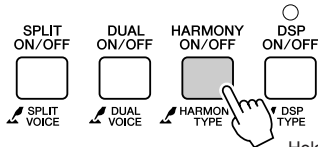

Hold for longer than a second.

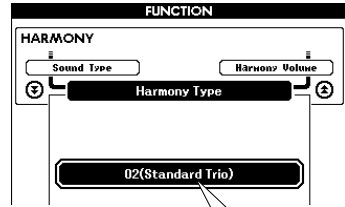

The currently selected harmony type

### 3 Use the dial to select a harmony type.

Refer to the Effect Type List on page 137 for information about the available harmony types. Try playing the keyboard with the harmony function. The effect and operation of each Harmony Type is different—refer to the below section “How to sound each Harmony Type” as well as the Effect Type List for details.

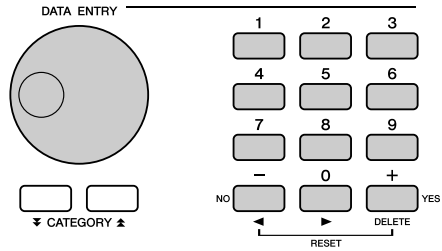

**NOTE**  
• The harmony notes can be added only to the Main Voice, not to Dual or Split Voices.  
• The keys left of the Split Point of the keyboard produce no harmony notes when the auto accompaniment is on (ACMP ON is lit).

#### ● How to sound each Harmony Type

- Harmony type 01 to 10, 13



Press the right-hand keys while playing chords in the auto accompaniment range of the keyboard when the Auto Accompaniment is on (page 27).

- Harmony type 15 to 18 (Echo)

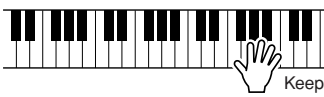

Keep holding down the keys.

- Harmony type 19 to 22 (Tremolo)



Keep holding down the keys.

- Harmony type 23 to 26 (Trill)



Hold down two keys.

You can adjust the Harmony Volume in the Function Settings (page 94).

## Adding Reverb

Reverb lets you play with a rich concert hall type ambience.

When you select a style or song the optimum reverb type for the voice used is automatically selected. If you want to select a different reverb type, use the procedure described below. Refer to the Effect Type List on page 138 for information about the available reverb types.

- 1 Press the [FUNCTION] button to call up the FUNCTION display.**

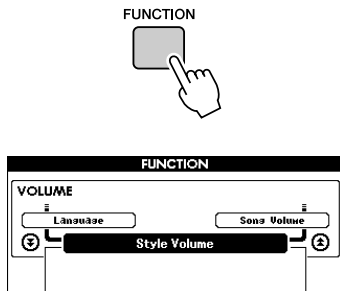

- 2 Use the CATEGORY [▲] and [▼] buttons to select the Reverb Type item.**

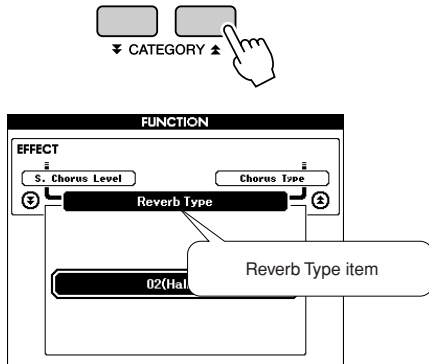

- 3 Use the dial to select a reverb type.**

You can check how the selected reverb type sounds by playing on the keyboard.

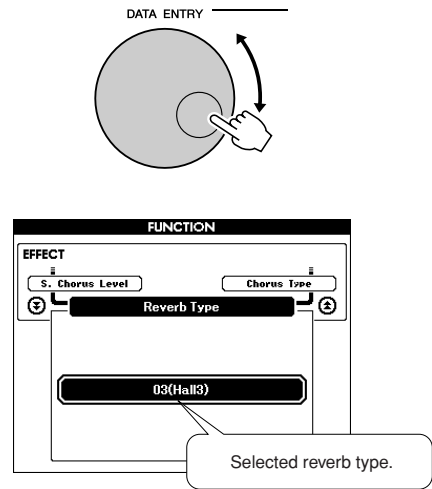

Refer to the Effect Type List on page 138 for information about the available reverb types.

### ● Adjusting the Reverb Level

You can individually adjust the amount of reverb that is applied to the main, dual, and split voices. (See page 93).

## Adding Chorus

The chorus effect creates a thick sound that is similar to many of the same voices being played in unison. When you select a style or song the optimum chorus type for the voice used is automatically selected. If you want to select a different chorus type, use the procedure described below.

- 1 Press the [FUNCTION] button to call up the FUNCTION display.

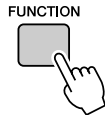

- 2 Use the CATEGORY [▲] and [▼] buttons to select the Chorus Type item.

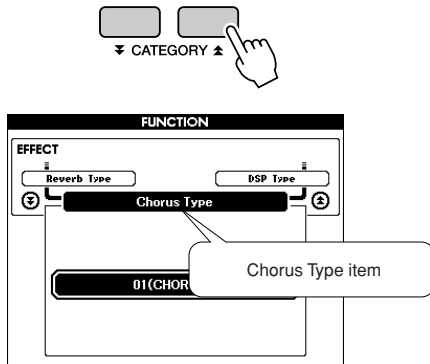

- 3 Use the dial to select a chorus type.

You can check how the selected chorus type sounds by playing on the keyboard.

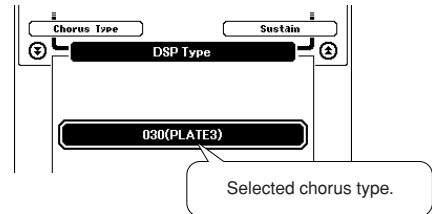
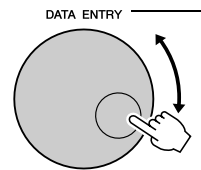

### ● Adjusting the Chorus Level

You can individually adjust the amount of chorus that is applied to the main, dual, and split voices. (See page 93).



## Adding DSP

DSP is term of abbreviated form of Digital Signal Processor. The DSP effect can be added to the Main and Dual Voices. These range from reverb-like ambience effects to distortion and other dynamic processing tools that let you enhance the sound, or completely transform it.

### 1 Use the [DSP ON/OFF] button to turn the DSP function on.

The indicator lights when DSP is on. To turn DSP off, press the [DSP ON/OFF] button again.

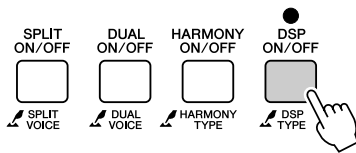

#### NOTE

- When DSP is turned on, the optimum DSP type for the current Voice is automatically selected.
- The volume of the currently playing Voice changes when turning DSP on or off. This is not a malfunction. The amount of change differs depending on the selected Voice.
- The DSP type is an overall setting—only one type can be selected. For this reason, when you play a newly loaded Song or Style, for example, the currently playing Voices may not sound as expected. This is normal, since the Song or Style has its own DSP type which replaces any selection you've made before loading. A similar phenomenon occurs when you use the [FF], [REW] buttons or A-B Repeat function during song playback.

### 2 Press and hold the [DSP ON/OFF] button for longer than a second.

The currently selected DSP type will be displayed.

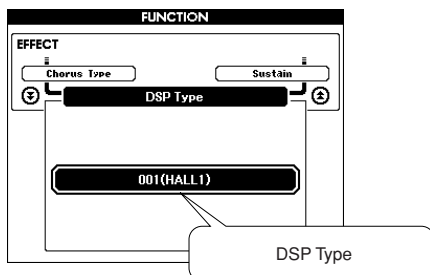
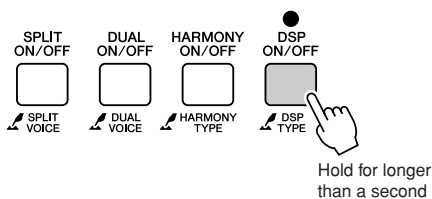

### 3 Use the dial to select a DSP type.

Refer to the DSP Type List on page 140 for information about the available DSP types.

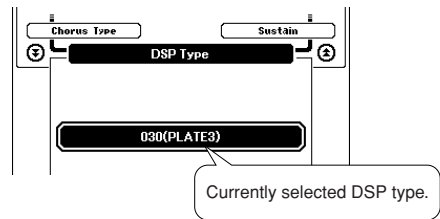
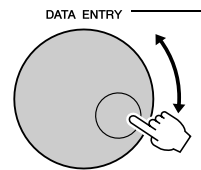

### ● Adjusting the DSP Level

You can individually adjust the amount of DSP that is applied to the main and dual voices. (See page 93).

## Adding Sustain

This function adds sustain to the keyboard voices. Use it when you want to add sustain to the voices at all times, regardless of damper operation. The sustain function does not affect split voice.

- 1 Press the [FUNCTION] button to call up the FUNCTION display.

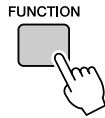

- 2 Use the CATEGORY [▲] and [▼] buttons to select the Sustain item.

The current setting is displayed.

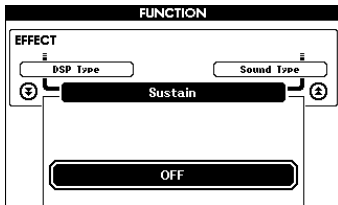
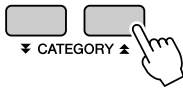

- 3 You can then use the [+] and [-] buttons to turn sustain on or off.

### NOTE

- The sustain of some voices may not be markedly affected when the sustain function is turned on.



# Handy Performance Features

## Tap Start

You can start the song/style by simply tapping the [TEMPO/TAP] button at the required tempo—4 times for time signatures in 4, and three times for time signatures in 3. You can change the tempo during song playback by pressing the button just twice.

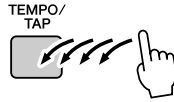

## Touch Response Sensitivity

You can adjust the keyboard's sensitivity to dynamics in three steps.

### 1 Press the [FUNCTION] button.

The currently selected function will appear in the display.

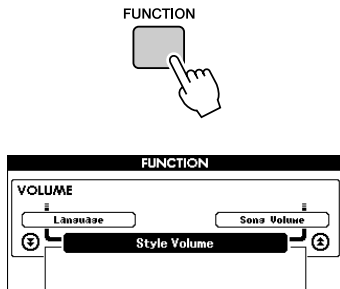

### 2 Use the CATEGORY [▲] and [▼] buttons to select the Touch Sensitivity item.

The currently selected touch sensitivity will be displayed.

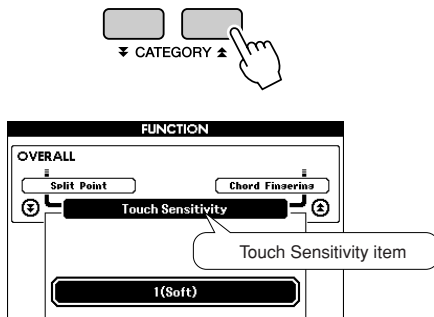

### 3 Use the dial to select a touch sensitivity setting between 1 and 3. Higher values produce greater (easier) volume variation in response to keyboard dynamics—i.e. greater sensitivity.

A setting of “4” results in a fixed touch response, or no level change no matter how hard or how soft you play the keys.

#### NOTE

• The initial default touch sensitivity setting is “2”.

## One Touch Setting

Sometimes selecting the ideal voice to play with a song or style can be confusing. The One Touch Setting feature automatically selects a well-balanced voice for you when you select a style or song. Simply select voice number “000” to activate this feature.

**1** Select voice number “000” (steps 1 to 2 on page 17).

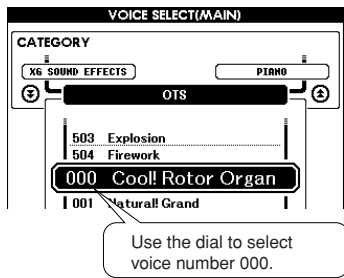

**2** Select and play back any song (steps 1 to 3 on page 33).

**3** Play the keyboard and remember the sound of the voice.

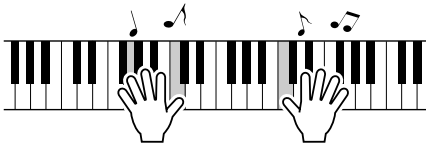

If you have stopped playback at some point during this procedure press the [START/STOP] button to start playback again.

**4** Use the dial to change songs, then play the keyboard and listen to the voice.

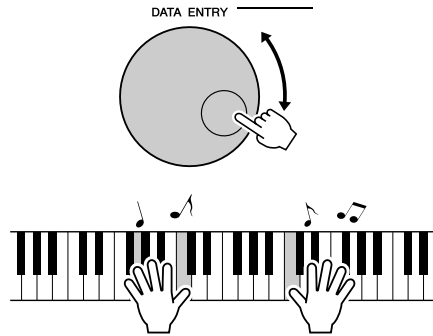

You should hear a different keyboard voice than you played in step 3. Watch the display while changing songs and you will see that different voices are selected for each song.

## Select a Sound Type

Select a sound type for the internal speakers from piano sound or style sound.

- 1 Press and hold the [PIANO PRESET] button for longer than a second.

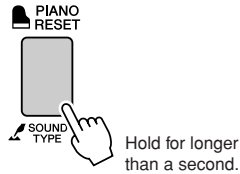

The currently selected sound type will appear.

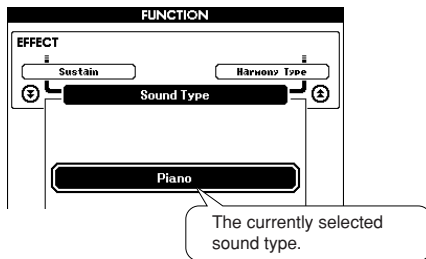

- 2 Use the dial to select the desired Sound Type.

Select Piano when you want to play only a piano sound, or select Style when you want to play a style.

**NOTE**

- When using headphones the normal sound is applied.

This function can also be set by using the [FUNCTION] button (see page 93).

## Pitch Controls

### ◆ Large Pitch Changes (Transpose)

The overall pitch of the instrument can be shifted up or down by a maximum of 1 octave in semitone increments.

**1** Press the [FUNCTION] button.

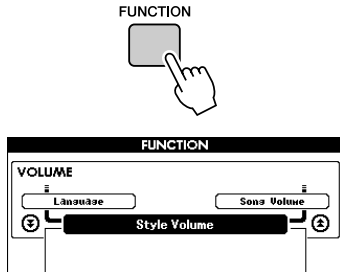

**2** Use the CATEGORY [▲] and [▼] buttons to select the Transpose item.

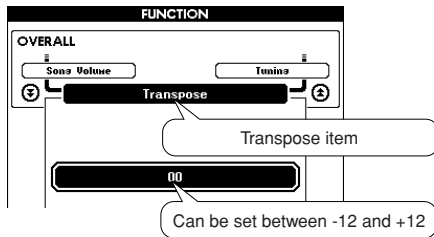

**3** Use the dial to set the transpose value between -12 and +12 as required.

**NOTE**

• The pitch of Drum Kits voices cannot be changed.

### ◆ Small Pitch Changes (Tuning)

The overall tuning of the instrument can be shifted up or down by a maximum of 100 cents in 1-cent increments (100 cents = 1 semitone).

**1** Press the [FUNCTION] button.

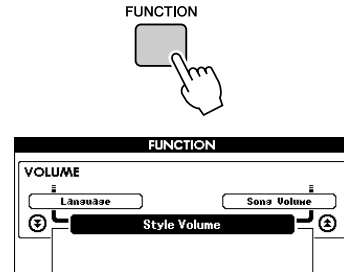

**2** Use the CATEGORY [▲] and [▼] buttons to select the Tuning item.

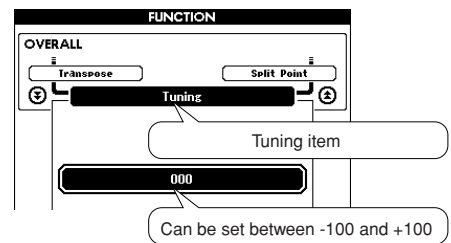

**3** Use the dial to set the tuning value between -100 and +100 as required.

**NOTE**

• The pitch of Drum Kits voices cannot be changed.



# Style (Auto-accompaniment) Functions

Basic operation of the Style (auto-accompaniment) feature is described on page 26 of the Quick Guide.

Here are some other ways you can play the styles, the style volume adjustment procedure, how you can play chords using the styles, and more.

## Pattern Variation (Sections)

This instrument features a wide variety of style “sections” that allow you to vary the arrangement of the accompaniment to match the song you are playing.

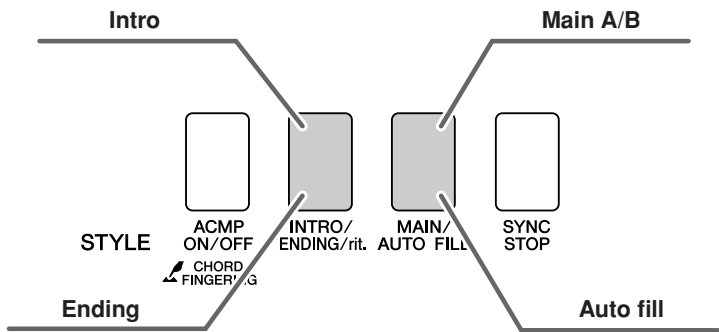

### ● INTRO section

This is used for the beginning of the Song. When the intro finishes playing, accompaniment shifts to the main section. The length of the intro (in measures) differs depending on the selected Style.

### ● MAIN section

This is used for playing the main part of the Song. It plays a main accompaniment pattern, and repeats indefinitely until another section’s button is pressed. There are two variations on the basic pattern (A and B), and the Style playback sound changes harmonically based on the chords you play with your left hand.

### ● Fill-in section

This is automatically added before changing to section A or B.

### ● ENDING section

This is used for the ending of the Song. When the ending is finished, the auto accompaniment stops automatically. The length of the ending (in measures) differs depending on the selected Style.

**1** Press the [STYLE] button and then select a style.

**2** Press the [ACMP ON/OFF] button to turn auto accompaniment on.

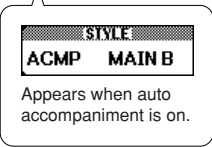
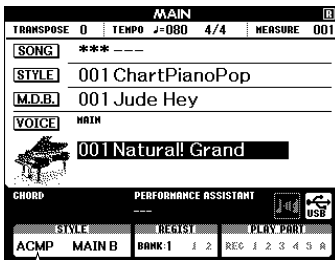
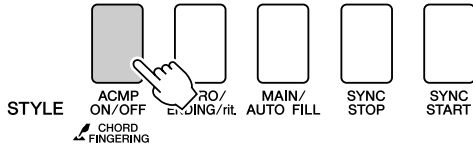

**3** Press the [SYNC START] button to turn synchro start on.

The indicator will flash when the synchro start standby mode will be engaged.

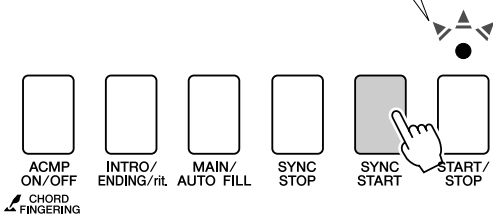

**● Synchro Start**  
 When the synchro start standby mode is engaged, style playback will begin as soon as you play a chord in the accompaniment range of the keyboard. You can disengage the synchro-start standby mode by pressing the [SYNC START] button again.

**4** Press the [MAIN/AUTO FILL] button.

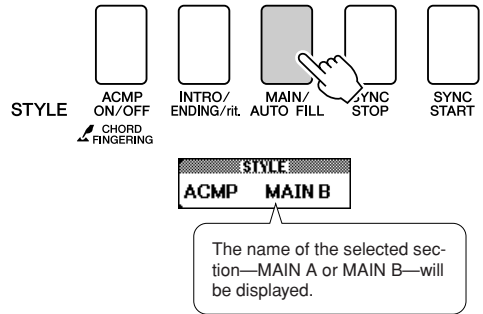

**5** Press the [INTRO/ENDING/rit.] button.

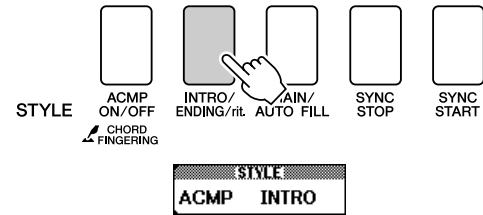

You're now ready to play the intro.

**6** As soon as you play a chord with your left hand, the Intro of the selected Style starts.

For this example, play a C major chord (as shown below). For information on how to enter chords, see "Playing Auto-accompaniment Chords" on page 31.

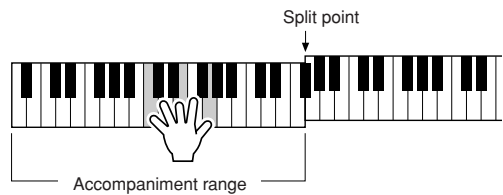



**7 Press the [MAIN/AUTO FILL] button.**

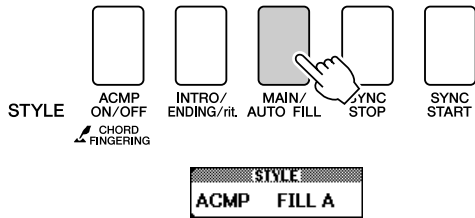

When the fill-in is finished, it leads smoothly into the selected main section A/B.

**8 Press the [INTRO/ENDING/rit.] button.**

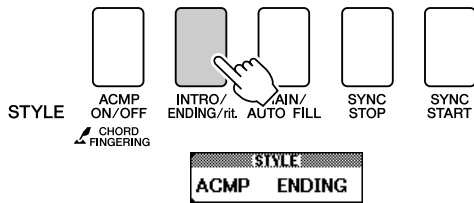

This switches to the ending section. When the ending is finished, the auto accompaniment stops automatically. You can have the ending gradually slow down (ritardando) by pressing the [INTRO/ENDING/rit.] button again while the ending is playing back.

● **Synchro Stop**

When this function is selected the accompaniment style will only play while you are playing chords in the accompaniment range of the keyboard. Style playback will stop when you release the keys. To turn the function on, press the [SYNC STOP] button.

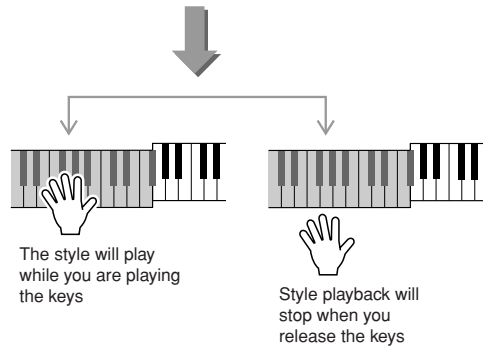
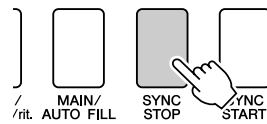

## Setting the Split Point

The initial default split point is key number 054 (the F#2 key), but you can change it to another key using the procedure described below.

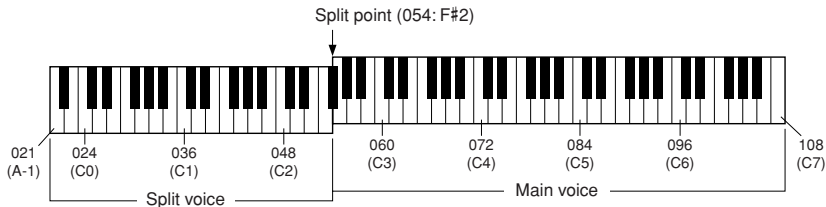

**1** Press the [FUNCTION] button.

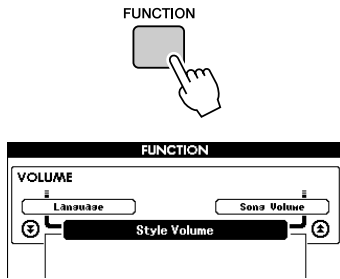

**2** Use the CATEGORY [ $\blacktriangle$ ] and [ $\blacktriangledown$ ] buttons to select the Split point item.

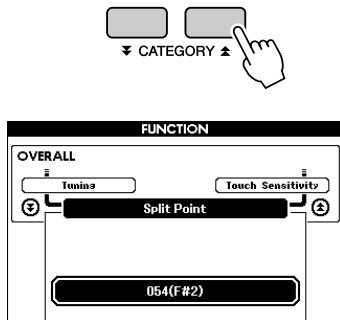

**3** Use the dial to set the split point to any key from 021(A-1) through 108 (C7).

**NOTE**

- When you change the split point the auto-accompaniment split point also changes.
- The split point cannot be changed during a song lesson.
- The split voice sounds when the split-point key is played.

**NOTE**

- You can also access the Split Point item by pressing the [FUNCTION] button and using the CATEGORY [ $\blacktriangle$ ] and [ $\blacktriangledown$ ] buttons to locate the item (page 92).

## Play a Style with Chords but No Rhythm (Stop Accompaniment)

When auto accompaniment is on (the ACMP ON icon is showing) and Synchro Start is off, you can play chords in the left-hand accompaniment range of the keyboard while the style is stopped and still hear the accompaniment chords. This is “Stop Accompaniment”, and any of the chord fingerings recognized by the instrument can be used (page 31).

Press the [ACMP ON/OFF] button to turn auto accompaniment on after pressing the [STYLE] button.

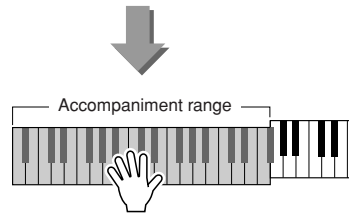
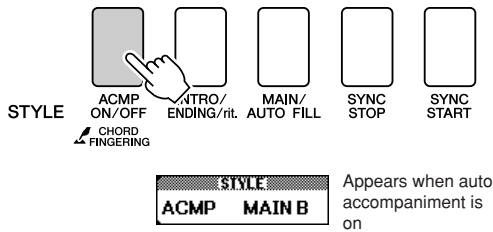

## Adjusting the Style Volume

Press the [STYLE] button to engage the style function.

**1** Press the [FUNCTION] button.

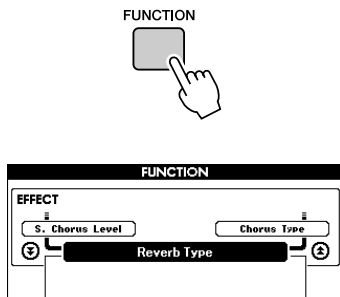

**2** Use the CATEGORY [▲] and [▼] buttons to select the Style Volume item.

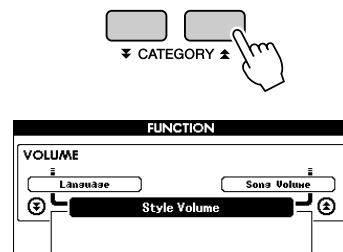

**3** Use the dial to set the style volume between 000 and 127.

## Chord Basics

Two or more notes played together constitute a “chord”.

The most basic chord type is the “triad” consisting of three notes: the root, third, and fifth degrees of the corresponding scale. A C major triad, for example, is made up of the notes C (the root), E (the third note of the C major scale), and G (the fifth note of the C major scale).

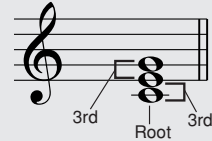

In the C major triad shown above, the lowest note is the “root” of the chord (this is the chord’s “root position” ... using other chord notes for the lowest note results in “inversions”). The root is the central sound of the chord, which supports and anchors the other chord notes.

The distance (interval) between adjacent notes of a triad in root position is either a major or minor third.

Major third—four half steps (semitones)

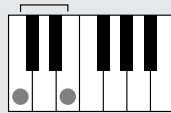

Minor third—three half steps (semitones)

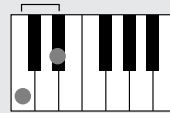

The lowest interval in our root-position triad (between the root and the third) determines whether the triad is a major or minor chord, and we can shift the highest note up or down by a semitone to produce two additional chords, as shown below.

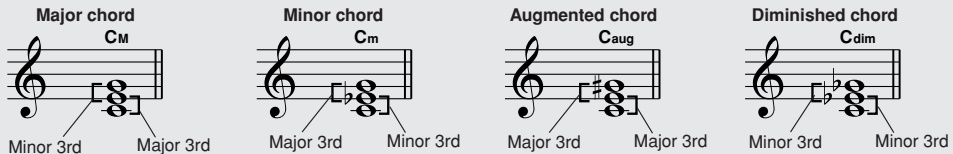

The basic characteristics of the chord sound remain intact even if we change the order of the notes to create different inversions. Successive chords in a chord progression can be smoothly connected, for example, by choosing the appropriate inversions (or chord “voicings”).

### ● Reading Chord Names

Chord names tell you just about everything you need to know about a chord (other than the inversion/voicing). The chord name tells you what the root of the chord is, whether it is a major, minor, or diminished chord, whether it requires a major or flatted seventh, what alterations or tensions it uses ... all at a glance.

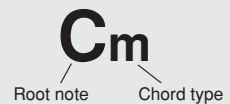

### ● Some Chord Types (These are just some of the “Standard” chord types recognized by this instrument.)

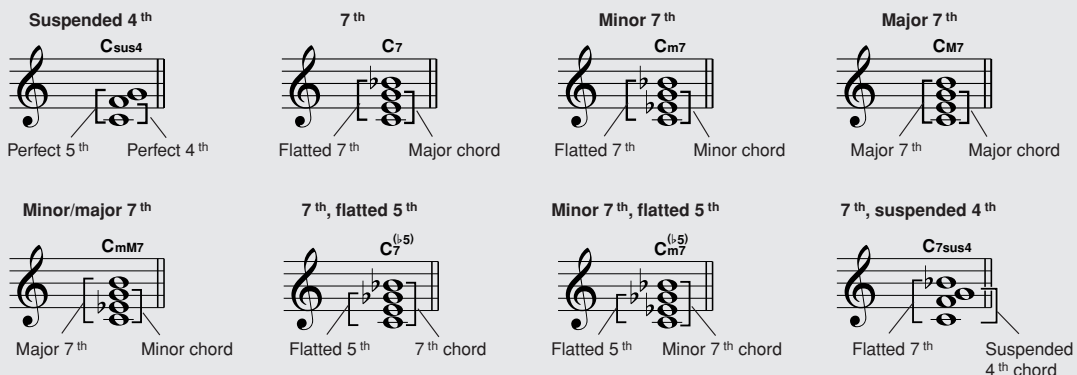

## ■ Recognized Standard Chords.....

All chords in the chart are “C-root” chords.

Chord Name/[Abbreviation]	Normal Voicing	Chord (C)	Display
Major [M]	1 - 3 - 5	C	C
Add ninth [(9)]	1 - 2 - 3 - 5	C <sup>(9)</sup>	C9
Sixth [6]	1 - (3) - 5 - 6	C <sub>6</sub>	C6
Sixth ninth [6(9)]	1 - 2 - 3 - (5) - 6	C <sub>6</sub> <sup>(9)</sup>	C6 <sup>9</sup> *
Major seventh [M7]	1 - 3 - (5) - 7	CM7	CM7
Major seventh ninth [M7(9)]	1 - 2 - 3 - (5) - 7	CM <sub>7</sub> <sup>(9)</sup>	CM7 <sup>9</sup> *
Major seventh add sharp eleventh [M7(#11)]	1 - (2) - 3 - #4 - 5 - 7 or 1 - 2 - 3 - #4 - (5) - 7	C <sub>M7</sub> <sup>(#11)</sup>	CM7#11 *
Flatted fifth [(b5)]	1 - 3 - b5	C <sup>(b5)</sup>	C <sup>b5</sup> *
Major seventh flatted fifth [M7b5]	1 - 3 - b5 - 7	C <sub>M7</sub> <sup>(b5)</sup>	CM7 <sup>b5</sup> *
Suspended fourth [sus4]	1 - 4 - 5	C <sub>sus4</sub>	Csus4
Augmented [aug]	1 - 3 - #5	C <sub>aug</sub>	Caug
Major seventh augmented [M7aug]	1 - (3) - #5 - 7	CM <sub>7aug</sub>	CM7aug *
Minor [m]	1 - b3 - 5	C <sub>m</sub>	Cm
Minor add ninth [m(9)]	1 - 2 - b3 - 5	C <sub>m</sub> <sup>(9)</sup>	Cm9
Minor sixth [m6]	1 - b3 - 5 - 6	C <sub>m6</sub>	Cm6
Minor seventh [m7]	1 - b3 - (5) - b7	C <sub>m7</sub>	Cm7
Minor seventh ninth [m7(9)]	1 - 2 - b3 - (5) - b7	C <sub>m7</sub> <sup>(9)</sup>	Cm7 <sup>9</sup>
Minor seventh add eleventh [m7(11)]	1 - (2) - b3 - 4 - 5 - (b7)	C <sub>m7</sub> <sup>(11)</sup>	Cm7 <sup>11</sup> *
Minor major seventh [mM7]	1 - b3 - (5) - 7	C <sub>mM7</sub>	CmM7
Minor major seventh ninth [mM7(9)]	1 - 2 - b3 - (5) - 7	C <sub>mM7</sub> <sup>(9)</sup>	CmM7 <sup>9</sup> *
Minor seventh flatted fifth [m7b5]	1 - b3 - b5 - b7	C <sub>m7</sub> <sup>(b5)</sup>	Cm7 <sup>b5</sup>
Minor major seventh flatted fifth [mM7b5]	1 - b3 - b5 - 7	C <sub>mM7</sub> <sup>(b5)</sup>	CmM7 <sup>b5</sup> *
Diminished [dim]	1 - b3 - b5	C <sub>dim</sub>	Cdim
Diminished seventh [dim7]	1 - b3 - b5 - 6	C <sub>dim7</sub>	Cdim7
Seventh [7]	1 - 3 - (5) - b7 or 1 - (3) - 5 - b7	C <sub>7</sub>	C7
Seventh flatted ninth [7(b9)]	1 - b2 - 3 - (5) - b7	C <sub>7</sub> <sup>(b9)</sup>	C7 <sup>b9</sup>
Seventh add flatted thirteenth [7(b13)]	1 - 3 - 5 - b6 - b7	C <sub>7</sub> <sup>(b13)</sup>	C7 <sup>b13</sup>
Seventh ninth [7(9)]	1 - 2 - 3 - (5) - b7	C <sub>7</sub> <sup>(9)</sup>	C7 <sup>9</sup>
Seventh add sharp eleventh [7(#11)]	1 - (2) - 3 - #4 - 5 - b7 or 1 - 2 - 3 - #4 - (5) - b7	C <sub>7</sub> <sup>(#11)</sup>	C7#11
Seventh add thirteenth [7(13)]	1 - 3 - (5) - 6 - b7	C <sub>7</sub> <sup>(13)</sup>	C7 <sup>13</sup>
Seventh sharp ninth [7(#9)]	1 - #2 - 3 - (5) - b7	C <sub>7</sub> <sup>(#9)</sup>	C7#9
Seventh flatted fifth [7b5]	1 - 3 - b5 - b7	C <sub>7b5</sub>	C7 <sup>b5</sup> *
Seventh augmented [7aug]	1 - 3 - #5 - b7	C <sub>7aug</sub>	C7aug
Seventh suspended fourth [7sus4]	1 - 4 - 5 - b7	C <sub>7sus4</sub>	C7sus4
Suspended second [sus2]	1 - 2 - 5	C <sub>sus2</sub>	Csus2 *

\* These chords are not shown in the Dictionary function.

**NOTE**

- Notes in parentheses can be omitted.
- Playing two same root keys in the adjacent octaves produces accompaniment based only on the root.
- A perfect fifth (1 + 5) produces accompaniment based only on the root and fifth which can be used with both major and minor chords.
- The chord fingerings listed are all in “root” position, but other inversions can be used—with the following exceptions: m7, m7<sup>b5</sup>, 6, m6, sus4, aug, dim7, 7<sup>b5</sup>, 6(9), sus2.

**NOTE**

- Inversion of the m7(11) chords are not recognized if the notes shown in parentheses are omitted.
- The auto accompaniment will sometimes not change when related chords are played in sequence (e.g. some minor chords followed by the minor seventh).
- Two-note fingerings will produce a chord based on the previously played chord.

## Playing Styles Using the Entire Keyboard

In “Play Along with a Style” on page 27 we described a method of playing styles in which chords were detected only to the left of the keyboard split point. By making the settings described below, however, chord detection for style accompaniment occurs over the entire range of the keyboard, allowing for even more dynamic style performance. In this mode only chords played in the normal way (page 31) can be detected.

- 1 Press and hold the [ACMP ON/OFF] button for longer than a second to select the function “Chord Fingering”.

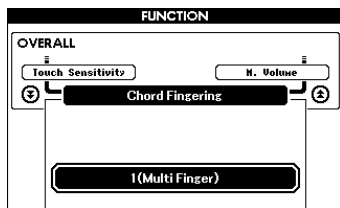
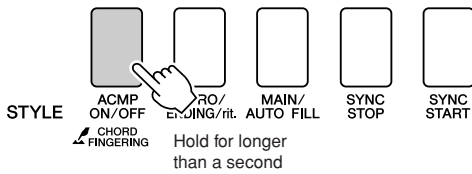

- 2 Use the dial to select 2 “FullKeyboard”.

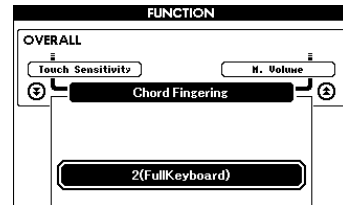
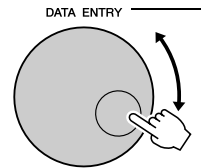

## Looking Up Chords Using the Chord Dictionary

The Dictionary function is essentially a built-in “chord book” that shows you the individual notes of chords. It is ideal when you know the name of a certain chord and want to quickly learn how to play it.

- 1 Press and hold the **LESSON [START]** button for longer than a second.

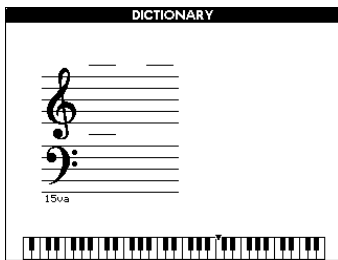
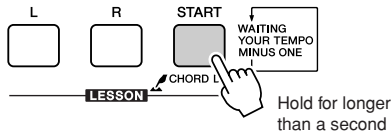

- 2 As an example, we'll learn how to play a GM7 (G major seventh) chord. Press the “G” key in the section of the keyboard labeled “ROOT”. (The note doesn't sound.) The root note you set is shown in the display.

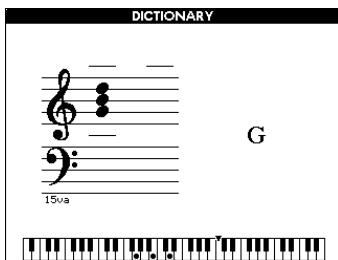
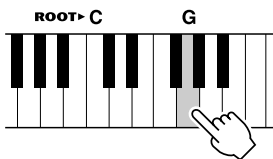

- 3 Press the “M7” (major seventh) key in the section of the keyboard labeled “CHORD TYPE”. (The note doesn't sound.) The notes you should play for the specified chord (root note and chord type) are shown in the display, both as notation and in the keyboard diagram.

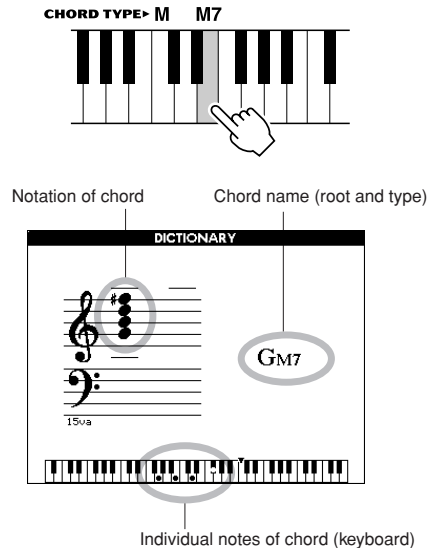

To call up possible inversions of the chord, press the [+]/[-] buttons.

**NOTE**

- About major chords: Simple major chords are usually indicated only by the root note. For example, “C” refers to C major. However, when specifying major chords here, make sure to select “M” (major) after pressing the root note.
- Be aware that the chord types explained here are the left-hand notes applied to various styles and different from the one for the performance assistant technology feature.

- 4 Try playing a chord in the auto accompaniment section of the keyboard, checking the indications in the display. When you've played the chord properly, a bell sound signals your success and the chord name in the display flash. Press the [EXIT] button to return to the MAIN display.



# Song Settings

## Song Volume

**1** Press the [FUNCTION] button.

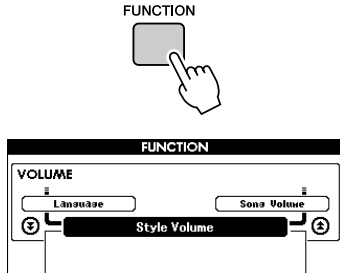

**2** Use the CATEGORY [ $\blacktriangle$ ] and [ $\blacktriangledown$ ] buttons to select the Song Volume item.

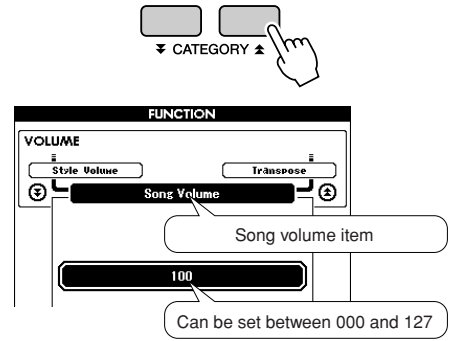

**3** Use the dial to set the song volume between 000 and 127.

**NOTE**

- Song volume can be adjusted while a song is selected.

## A-B Repeat

You can specify a section of a song—"A" is the start point and "B" is the end point—for repeat playback.



**1** Play the song (page 32) and press the [A-B REPEAT] button at the beginning of the section you want to repeat (the "A" point).

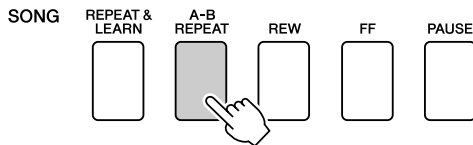

**2** Press the [A-B REPEAT] button a second time at the end of the section you want to repeat (the "B" point).

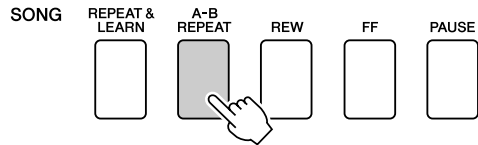

**3** The specified A-B section of the song will now play repeatedly.

You can stop repeat playback at any time by pressing the [A-B REPEAT] button.

**NOTE**

- Repeat start and end points cannot be specified within the same measure. While the song is stopped.
- The current measure number is shown in the display during playback.
- If you want to set the start point "A" at the very beginning of the song, press the [A-B REPEAT] button before starting playback of the song.



## Muting Independent Song Parts

Each “track” of a song plays a different part of the song—melody, percussion, accompaniment, etc. You can mute individual tracks and play the muted part on the keyboard yourself, or simply mute tracks other than the ones you want to listen to. To mute a track, press the appropriate track button (TRACK [1]–[5], [A]) button. Press the same button a second time to disengage track muting.

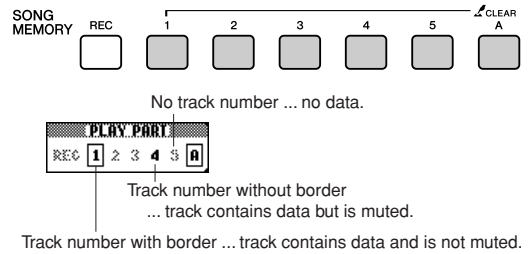

## Change the Melody Voice

You can change a song’s melody voice to any other voice you prefer.

**Press the lesson [L] and [R] buttons simultaneously so that “LR” appears in the upper right corner of the MAIN display. Select the song and play it.**

**1 Press the [VOICE] button for longer than a second.**

The VOICE SELECT (MELODY R or MELODY L) display will appear so you can select the Melody R or Melody L voice. Pressing the [VOICE] button alternates between VOICE SELECT MELODY R and MELODY L.

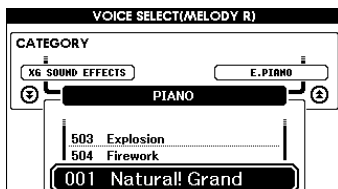
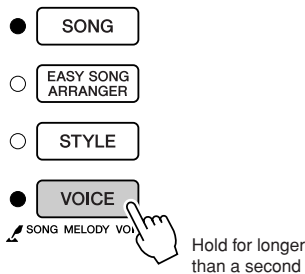

**2 Use the dial to select the voice.**

As you select different melody voices, only the melody voice changes while the song will remain the same.



# Memorize Your Favorite Panel Settings

This instrument has a Registration Memory feature that lets you save your favorite settings for easy recall whenever they're needed. Up to 16 complete setups can be saved (8 banks of two setups each).

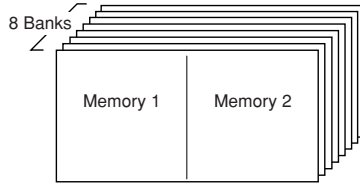

Up to 16 presets (eight banks of two each) can be memorized.

## Saving to the Registration Memory

- 1 Set the panel controls as required—select a voice, accompaniment style, etc.
- 2 Press the [MEMORY/BANK] button. A bank number will appear in the display when you release the button.

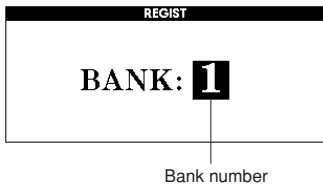
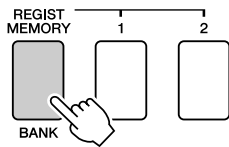

- 3 Use the dial or the [1]–[8] number buttons to select a bank number from 1 to 8.

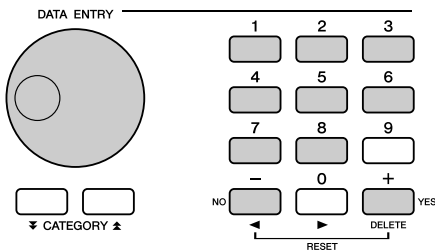

### NOTE

• Data cannot be saved to the registration memory during song playback.

- 4 Press the REGIST MEMORY [1] or [2] button while holding the [MEMORY/BANK] button to store the current panel settings to the specified registration memory.

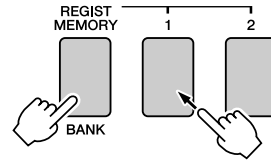

Press the [EXIT] button to return to the MAIN display in order to check the bank and registration memory numbers.

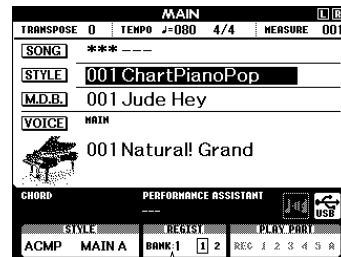

### NOTE

• You can also save your panel settings memorized to registration memory button into USB flash memory as the user file or to a computer as the backup file.

### NOTE

• If you select a Registration Memory number that already contains data, the previous data is deleted and overwritten by the new data.

### CAUTION

• Do not turn off the power while saving settings to the registration memory, otherwise the data may be damaged or lost.

## Recalling a Registration Memory

**1** Press the [MEMORY/BANK] button. A bank number will appear in the display when you release the button.

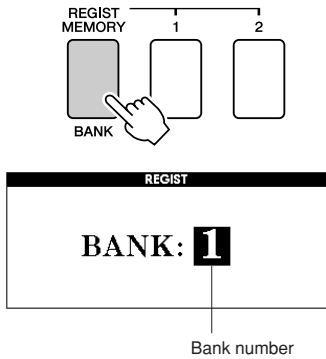

**2** Use the dial or the [1]–[8] number buttons to select bank you want to recall.

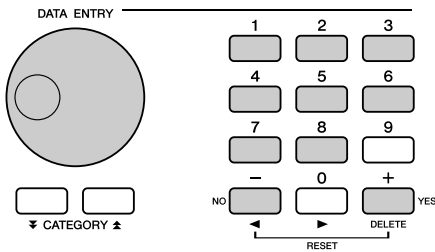

You can check whether the panel settings are stored in registration memory 1 or 2 by pressing the [EXIT] button to return to the MAIN display.

**3** Press the REGIST MEMORY button, [1] or [2], containing the settings you want to recall. The panel controls will be instantly set accordingly.

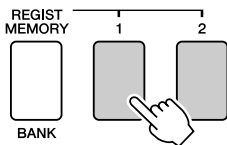

### ● Settings That Can be Saved to the Registration Memory

#### • Style settings\*

Style number, Auto Accompaniment ON/OFF, Split Point, Style settings (Main A/B), Style Volume, Tempo, Chord Fingering

#### • Voice settings

Main Voice setting (Voice number, Volume, Octave, Pan, Reverb Level, Chorus Level, DSP Level), Dual Voice settings (Dual ON/OFF, Voice number, Volume, Octave, Pan, Reverb Level, Chorus Level, DSP Level), Split Voice settings (Split ON/OFF, Voice number, Volume, Octave, Pan, Reverb Level, Chorus Level)

#### • Effect settings

Reverb Type, Chorus Type, Sustain ON/OFF, DSP ON/OFF, DSP Type

#### • Harmony settings

Harmony ON/OFF, Harmony Type, Harmony Volume

#### • Other settings

Transpose

\* Style settings are not available for Registration Memory when using the Song features.



# The Functions

The “Functions” provide access to a range of detailed instrument parameters for tuning, setting the split point, and adjusting the voices and effects. Take a look at the function list starting on the opposite page. There are 49 function parameters in all.

When you locate a function you want to set up, simply select the function’s display name and adjust as required.

## Selecting and Setting Functions

**1** Find the function you want to set in the list that begins on page 93.

**2** Press the [FUNCTION] button.

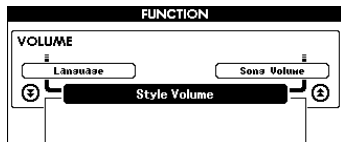
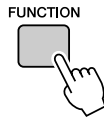

**3** Select a function.

Press the CATEGORY [ $\blacktriangle$ ] and [ $\blacktriangledown$ ] buttons as many times as necessary until the function’s display name appears in the display.

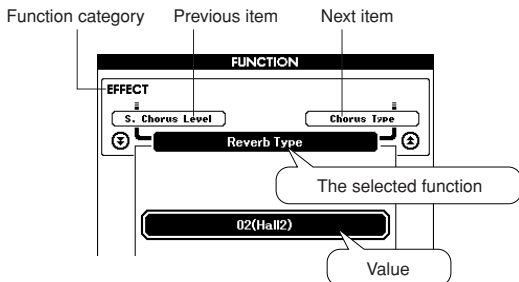
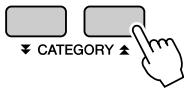

**4** Use the dial, the [+] and [-] buttons, or the [0]–[9] number buttons to set the selected function as required.

The [+] and [-] buttons are used to make ON/OFF type settings: [+] = ON, [-] = OFF.

In some cases the [+] button will initiate execution of the selected function, and the [-] will cancel the selection.

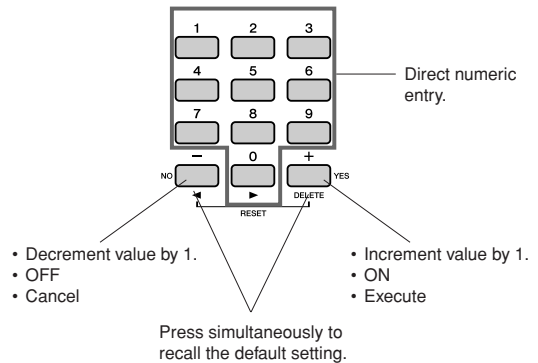

Some Function settings are stored in memory as soon as they are changed. See “The Backup Parameters” on page 65 for information on the function settings that are stored on the instrument.

To restore all initial factor default settings perform the “Backup Clear” procedure described in the “Initialization” section on page 65.

## ● Function Setting List

Category	Function Item	Range/Settings	Description
VOLUME	Style Volume	000–127	Determines the volume of the Style.
	Song Volume	000–127	Determines the volume of the Song.
OVERALL	Transpose	-12→+12	Determines the pitch of the instrument by semitone increments.
	Tuning	-100→+100	Sets the pitch of the instrument's sound in 1-cent increments.
	Split Point	021(A-1)–108(C7)	Determines the highest key for the Split voice and sets the Split "point"—in other words, the key that separates the Split (lower) and Main (upper) voices. The Split Point setting and Accompaniment Split Point setting are automatically set to the same value.
	Touch Sensitivity	1(Soft), 2(Medium), 3(Hard), 4 (Off)	Determines the sensitivity of the feature.
	Chord Fingering	1(Multi Finger), 2(FullKeyboard)	Sets the chord detection mode. In the Multi Finger mode both normal chords and simple chords played to the left of the split point are detected. In the Full Keyboard mode normal chords played anywhere on the keyboard will be detected, and the notes played will be sound as well.
MAIN VOICE	Main Volume	000–127	Determines the volume of the Main voice.
	Main Octave	-2→+2	Determines the octave range for the Main voice.
	Main Pan	000 (left)–64 (center)–127 (right)	Determines the pan position of the Main voice in the stereo image. The value "0" results in the sound being panned full left; the value "127" results in the sound being panned full right.
	Main Reverb Level	000–127	Determines how much of the Main voice's signal is sent to the Reverb effect.
	Main Chorus Level	000–127	Determines how much of the Main voice's signal is sent to the Chorus effect.
	Main DSP Level	000–127	Determines how much of the Main voice's signal is sent to the DSP effect.
DUAL VOICE	Dual Volume	000–127	Determines the volume of the Dual voice.
	Dual Octave	-2→+2	Determines the octave range for the Dual voice.
	Dual Pan	000 (left)–64 (center)–127 (right)	Determines the pan position of the Dual voice in the stereo image. The value "0" results in the sound being panned full left; the value "127" results in the sound being panned full right.
	Dual Reverb Level	000–127	Determines how much of the Dual voice's signal is sent to the Reverb effect.
	Dual Chorus Level	000–127	Determines how much of the Dual voice's signal is sent to the Chorus effect.
	Dual DSP Level	000–127	Determines how much of the Dual voice's signal is sent to the DSP effect.
SPLIT VOICE	Split Volume	000–127	Determines the volume of the Split voice.
	Split Octave	-2→+2	Determines the octave range for the Split voice.
	Split Pan	000 (left)–64 (center)–127 (right)	Determines the pan position of the Split voice in the stereo image. The value "0" results in the sound being panned full left; the value "127" results in the sound being panned full right.
	Split Reverb Level	000–127	Determines how much of the Split voice's signal is sent to the Reverb effect.
	Split Chorus Level	000–127	Determines how much of the Split voice's signal is sent to the Chorus effect.
EFFECT	Reverb Type	01–36	Determines the Reverb type, including off. (See the list on page 138)
	Chorus Type	01–45	Determines the Chorus type, including off. (See the list on page 139)
	DSP Type	001–239	Determines the DSP type, including off. (See the list on page 140)
	Sustain	ON/OFF	Determines whether or not sustain is always applied to the MAIN/DUAL voices. It is applied continuously when ON, or not applied when OFF. (page 74)
	Sound Type	Piano/Style	Determines the sound type, optimizing it either for a simple, pure piano sound, or for a wide, dynamic multi-instrument style sound.

Category	Function Item	Range/Settings	Description
HARMONY	Harmony Type	01–26	Determines the Harmony type. (See the list on page 137)
	Harmony Volume	000–127	Determines the volume of the Harmony effect.
PAT	P.A.T. Type	CHORD, CHORD/FREE, MELODY, CHORD/MELODY	Determines the performance assistant technology feature type. (See the list on page 39)
PC	PC Mode	PC1/PC2/OFF	Optimizes the MIDI settings when you connect to a computer (page 105).
MIDI	Local	ON/OFF	Determines whether the instrument's keyboard controls the internal tone generator (ON) or not (OFF). (page 105)
	External Clock	ON/OFF	Determines whether the instrument synchronizes to the internal clock (OFF) or an external clock (ON). (page 105)
	Keyboard Out	ON/OFF	Determines whether keyboard performance data of the instrument is transmitted (ON) or not (OFF).
	Style Out	ON/OFF	Determines whether Style data is transmitted (ON) via USB or not (OFF) during Style playback.
	Song Out	ON/OFF	Determines whether User Song is transmitted (ON) via USB or not (OFF) during Song playback.
	Initial Setup	YES/NO	Lets you send the data of the panel settings to a computer. Press [+] to send, or press [-] to cancel.
METRONOME	Time Signature - Numerator	01–60	Determines the time signature of the Metronome.
	Time Signature - Denominator	2, 4, 8, 16	Sets the length of each metronome beat.
	Bell	ON/OFF	Determines whether a bell accent will be sounded (ON) or not (OFF).
	Metronome Volume	000–127	Determines the volume of the Metronome.
SCORE	Quantize	1(1/4 note), 2(1/4 note triplet), 3(1/8 note), 4(1/8 note triplet), 5(1/16 note), 6(1/16 note triplet), 7(1/32 note), 8(1/32 note triplet)	Depending on the song data, you can make the score more readable by adjusting the timing of the notes. This determines the minimum timing resolution used in the song. For example, if there are both quarter notes and eighth notes in the song, you should set this value to "eighth note". Any notes or rests shorter than this value will not be shown in the score.
LESSON	Right-Part	GuideTrack 1–16	Determines the guide track number for your right hand lesson. The setting is effective for songs in SMF format 0 and 1 transferred from a computer.
	Left-Part	GuideTrack 1–16	Determines the guide track number for your left hand lesson. The setting is effective for songs in SMF format 0 and 1 transferred from a computer.
	Grade	ON/OFF	Determines whether the Grade function is on or off.
UTILITY	Demo Cancel	ON/OFF	Determines whether Demo cancel is enabled or not. When this is set to ON, the Demo Song will not play, even if the [DEMO] button is pressed.
LANGUAGE	Language	English/Japanese	Determines the display language for the demo displays, song file names, lyrics and certain display messages. All other messages and names are displayed in English. When this is set to Japanese, the file names are displayed in the Japanese font. The lyrics display follows the language setting originally made in the song data; however, when no such setting exists, the setting here is used.

\* All these settings can be conveniently reset to their initial default values by pressing the [+] and [-] buttons simultaneously. (The exception to this is Initial Send, which is an operation, not a setting.)



# Saving and Loading Data

USB flash memory is a memory medium used for storing data.

When a USB flash memory is inserted in this instrument's USB TO DEVICE terminal, registered settings can be saved from or loaded into the instrument. USB flash memory can also be used to transfer Song, Style, and Music Database files to the instrument, where they can be selected and used in the same way as the internal data. In this section we'll look at the procedures for setting up and formatting USB flash memory devices, as well as for saving and loading data to and from them.

Before using a USB device, read through the "Precautions when using the USB TO DEVICE terminal" section on page 96.

## Connecting a USB Flash Memory

**1** Connect a USB flash memory to the USB TO DEVICE terminal, being careful to insert it with the proper orientation.

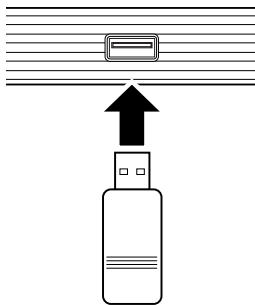

A message (information or confirmation dialog) sometimes appears on the display to facilitate operation. Refer to the "Messages" on page 112 for an explanation of each message.

**2** Check that the file control icon is shown in the MAIN display.

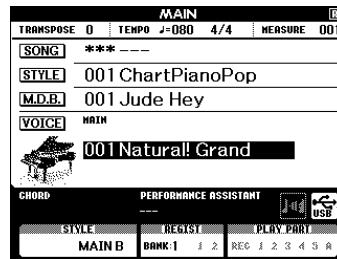

Appears while the memory device is being mounted.



File Control Icon



You can go to the FILE CONTROL display from which you can access file operations by pressing the [MENU] button from this display. (Do not press this button now, but only when instructed to in the sections below.)

Menu	Reference Page
Format	97
User File Save	98
User Song Save	99
Load	100
USB Delete	101
User Delete	102

### NOTE

- No sound will be produced if you play the keyboard while the FILE CONTROL display is showing. Also, in this state only buttons related to file functions will be active.

### NOTE

- The FILE CONTROL display will not appear in any of the following cases:
  - During style or song playback.
  - During a lesson.
  - While data is being loaded from a USB flash memory.

## ■ Precautions when using the USB TO DEVICE terminal

This instrument features a built-in USB TO DEVICE terminal. When connecting a USB device to the terminal, be sure to handle the USB device with care. Follow the important precautions below.

### NOTE

- Although CD-R/RW drives can be used to read data to the instrument, they cannot be used for saving data.

### ● Compatible USB devices

- USB storage devices (flash memory, floppy disk drive)

The instrument does not necessarily support all commercially available USB devices. Yamaha cannot guarantee operation of USB devices that you purchase. Before purchasing a USB device for use with this instrument, please visit the following web page:

<http://music.yamaha.com/download/>

### NOTE

- Other USB devices such as a computer keyboard or mouse cannot be used.

### ● Connecting USB device

- When connecting a USB device to the USB TO DEVICE terminal, make sure that the connector on the device is appropriate and that it is connected in the proper direction.

### CAUTION

- Do not close the key cover when a USB device is connected to the USB TO DEVICE terminal. Doing so can damage the USB device.

- Though the instrument supports the USB 1.1 standard, you can connect and use a USB 2.0 storage device with the instrument. However, note that the transfer speed is that of USB 1.1.

### ● Using USB Storage Devices

By connecting the instrument to a USB storage device, you can save data you've created to the connected device, as well as read data from the connected device.

### NOTE

- Although CD-R/RW drives can be used to read data to the instrument, they cannot be used for saving data.

### The number of USB storage device to be used

Only one USB storage devices can be connected to the USB TO DEVICE terminal.

### Formatting USB storage media

When a USB storage device is connected or media is inserted, a message may appear prompting you to format the device/media. If so, execute the Format operation (page 97).

### CAUTION

- The format operation overwrites any previously existing data. Make sure that the media you are formatting does not contain important data.

### To protect your data (write-protect)

To prevent important data from being inadvertently erased, apply the write-protect provided with each storage device or media. If you are saving data to the USB storage device, make sure to disable write-protect.

### Connecting/removing USB storage device

Before removing the media from the device, make sure that the instrument is not accessing data (such as in the Save and Delete operations).

### CAUTION

- Avoid frequently turning the power on/off to the USB storage device, or connecting/disconnecting the device too often. Doing so may result in the operation of the instrument "freezing" or hanging up. While the instrument is accessing data (such as during Save, Delete, Load and Format operations) or is mounting the USB storage device (shortly after the connection), do NOT unplug the USB connector, do NOT remove the media from the device, and do NOT turn the power off to either device. Doing so may corrupt the data on either or both devices.



## Formatting USB Flash Memory

New USB flash memory must be formatted before they can be used by this instrument.

### **CAUTION**

- If you format a USB flash memory that already contains data, all of the data will be erased. Be careful not to erase important data when using the format function.

- 1 After connecting the USB flash memory to be formatted to the instrument's USB TO DEVICE terminal, check that the icon is showing in the MAIN display.



- 2 Press the FILE CONTROL [MENU] button.

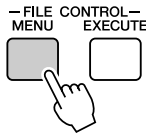

- 3 Use the CATEGORY [▲] and [▼] buttons to select the Format item.

The display prompts you for confirmation.

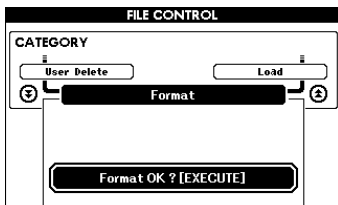
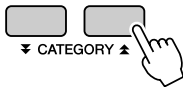

- 4 Press the [EXECUTE] button and the display prompts you for confirmation.

You can press the [-] button at this point to cancel the operation.

- 5 Press the [EXECUTE] button again, or the [+] button, and the format operation will begin.

### **CAUTION**

- Once the format-in-progress message appears on the display the format operation cannot be canceled. Never turn off the power or remove the USB flash memory during this operation.

- 6 A message will appear on the display to inform you that the operation has finished.

Press the [EXIT] button to return to the MAIN display.

### **NOTE**

- If the USB flash memory has been write-protected, an appropriate message will appear on the display and you will not be able to execute the operation.

## Saving Registration Memory data to USB Flash Memory

This operation saves Registration Memory data as a “User File” to a USB flash memory device. The User File name will have a “.usr” extension which will not appear in the instrument’s display.

- 1** Make sure that a properly formatted USB flash memory has been properly connected to the instrument’s USB TO DEVICE terminal, and that the icon is showing in the MAIN display.
- 2** Press the FILE CONTROL [MENU] button.
- 3** Use the CATEGORY [▲] and [▼] buttons to locate the **Regist Save** item. A default file name will automatically be created.

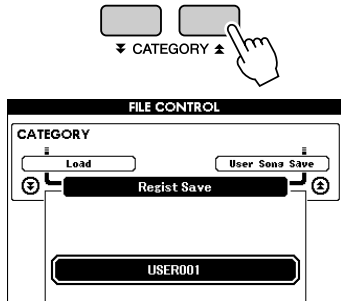

### ● To Overwrite an Existing File

If you want to overwrite a file that already exists on the USB flash memory, use the dial or the [+] and [-] buttons to select the file, then skip ahead to step 6.

#### NOTE

- Up to 100 user files can be saved to a single USB flash memory.
- If the USB flash memory has been write-protected, an appropriate message will appear on the display and you will not be able to execute the operation.
- If there is not enough capacity left on the USB flash memory to save the data an appropriate message will appear on the display and you will not be able to save the data. Erase unwanted files from the USB flash memory to make more memory available (page 101), or use a different USB flash memory.
- Refer to the “Messages” list on page 112 for other possible errors that might prevent you from completing the operation.

- 4** Press the [EXECUTE] button. A cursor will appear below the first character in the file name.

- 5** Change the file name as necessary.

- The [-] button moves the cursor to the left, and the [0] button moves it to the right.
- Use the dial to select a character for the current cursor location.
- The [+] button deletes the character at the cursor location.

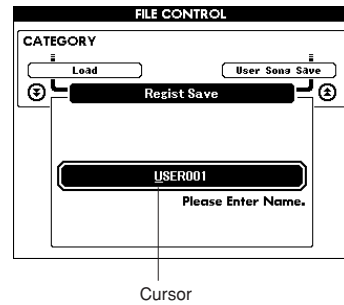
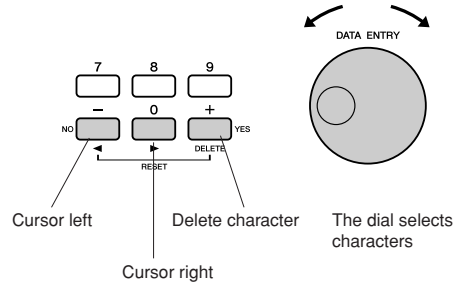

- 6** Press the [EXECUTE] button. The display prompts you for confirmation.

You can cancel the save operation at this point by pressing the [-] button.

- 7** Press the [EXECUTE] button again, or the [+] button, and the save operation will begin.

The file will be stored to the USER FILE folder in the USB flash memory.

#### CAUTION

- Once the save-in-progress message appears on the display the operation cannot be canceled. Never turn off the power or remove the USB flash memory during this operation.

- 8** A message will appear on the display to inform you that the operation has finished.

Press the [EXIT] button to return to the MAIN display.

#### NOTE

- If an existing filename is specified the display prompts you for confirmation. Press [EXECUTE] or [+] if it is OK to overwrite the file, or [-] to cancel.
- The amount of time it will take to perform the save operation will depend on the condition of the USB flash memory.

## Save a User Song to USB Flash Memory

This operation saves a user song (song numbers 031–035) to USB flash memory.

- 1** Make sure that a properly formatted USB flash memory has been properly connected to the instrument's USB TO DEVICE terminal, and that the icon is showing in the MAIN display.
- 2** Press the FILE CONTROL [MENU] button.
- 3** Use the CATEGORY [▲] and [▼] buttons to locate the User Song Save item. The SOURCE FILE—a user song name—will be highlighted.

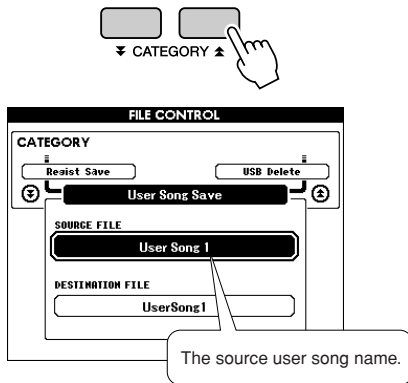

- 4** Use the dial to select the source user song. You can press the [+] and [-] buttons simultaneously to select the first user song.
- 5** Press the [EXECUTE] button. The DESTINATION SONG will be highlighted, and a default name will automatically be created.

### ● To Overwrite an Existing File

If you want to overwrite a file that already exists on the USB flash memory, use the dial or the [+] and [-] buttons to select the file, then skip ahead to step 7.

- 6** Press the [EXECUTE] button. A cursor will appear below the first character in the file name.

- 7** Change the file name as necessary. Refer to “Saving Registration Memory data to USB Flash Memory” on page 98 for filename entry.

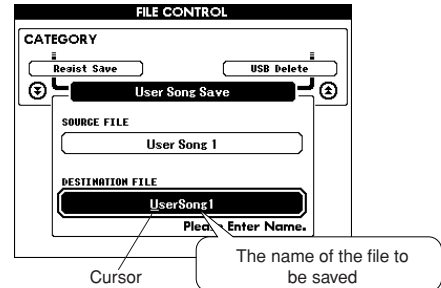

- 8** Press the [EXECUTE] button. The display prompts you for confirmation. You can cancel the save operation at this point by pressing the [-] button.
- 9** Press the [EXECUTE] button again, or the [+] button, and the save operation will begin. The user song will be stored to the USER FILE folder in the USB flash memory.

### ⚠ CAUTION

- Once the save-in-progress message appears on the display the operation cannot be canceled. Never turn off the power or remove the USB flash memory during this operation.

- 10** A message will appear on the display to inform you that the operation has finished.

Press the [EXIT] button to return to the MAIN display.

### NOTE

- If an existing filename is specified the display prompts you for confirmation. Press [EXECUTE] or [+] if it is OK to overwrite the file, or [-] to cancel.
- The amount of time it will take to perform the save operation will depend on the condition of the USB flash memory.

## Loading Files from a USB Flash Memory

User files as well as Style, Song, and Music Database files residing on a USB flash memory can be loaded into the instrument.

### **CAUTION**

- If you load a User File registration memory data will be overwritten by the newly loaded data. Save important data to a USB flash memory before loading data that will overwrite it.

- 1 With the USB flash memory containing the file you want to load connected to the USB TO DEVICE connector, check that the File Control icon is shown in the MAIN display.



- 2 Press the FILE CONTROL [MENU] button.
- 3 Use the CATEGORY [▲] and [▼] buttons to locate the Load item.

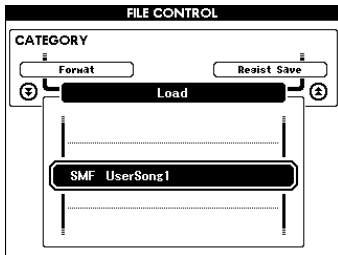
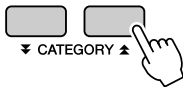

- 4 Use the dial to select the file you want to load.

All user files in the USB flash memory will be displayed first, followed by the style files, song files and music database files.

Files must be located in the “User Files” folder in the USB flash memory. Files located outside of that folder will not be recognized.

- 5 Press the [EXECUTE] button. The display prompts you for confirmation.

You can cancel the load operation at this point by pressing the [-] button.

- 6 Press the [EXECUTE] button again, or the [+] button, and the load operation will begin.

### **CAUTION**

- Once the load-in-progress message appears on the display the operation cannot be canceled. Never turn off the power or remove the USB flash memory during this operation.

- 7 A message will appear on the display to inform you that the operation has finished.

Press the [EXIT] button to return to the MAIN display.

## Deleting Data from a USB Flash Memory

This procedure deletes User, Style, Song, and Music Database files from a USB flash memory.

- 1 Make sure that the USB flash memory containing the file(s) you want to delete has been properly connected to the instrument's USB TO DEVICE terminal, and that the icon is showing in the MAIN display.



- 2 Press the FILE CONTROL [MENU] button.
- 3 Use the CATEGORY [▲] and [▼] buttons to locate the USB Delete item.

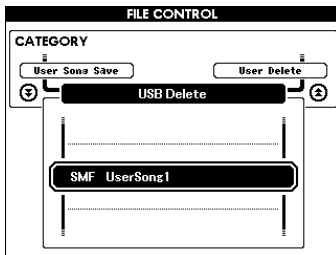
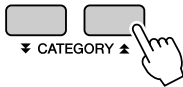

- 4 Use the dial to select the file you want to delete.

All User files in the USB flash memory will be displayed first, followed by the style files, song files and music database files.

Files must be located in the “User Files” folder in the USB flash memory. Files located outside of that folder will not be recognized.

- 5 Press the [EXECUTE] button. The display prompts you for confirmation.

You can cancel the delete operation at this point by pressing the [-] button.

- 6 Press the [EXECUTE] button again, or the [+] button, and the delete operation will begin.

### CAUTION

- Once the delete-in-progress message appears on the display the operation cannot be canceled. Never turn off the power or remove the USB flash memory during this operation.

- 7 A message will appear on the display to inform you that the operation has finished.

Press the [EXIT] button to return to the MAIN display.

### NOTE

- If the USB flash memory has been write-protected, an appropriate message will appear on the display and you will not be able to execute the operation.

## Delete User Data from the Instrument

This procedure deletes the User Song as well as Style, Song, and Music Database files transferred from an external device such as a computer. This operation does not erase the preset data.

**1** Press the FILE CONTROL [MENU] button.

**2** Use the CATEGORY [▲] and [▼] buttons to locate the User Delete item.

Only “User Delete” can be selected if no USB flash memory is connected to the instrument.

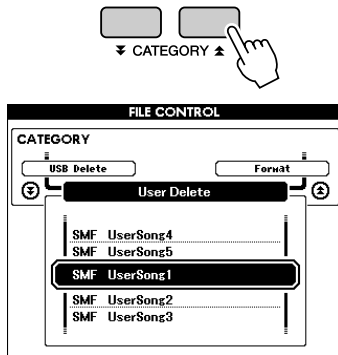

**3** Use the dial to select the file you want to delete.

All user songs will be displayed first, followed by the song, style and music database files.

**4** Press the [EXECUTE] button. The display prompts you for confirmation.

You can cancel the delete operation at this point by pressing the [-] button.

**5** Press the [EXECUTE] button again, or the [+] button, and the delete operation will begin.

### CAUTION

• Once the delete-in-progress message appears on the display the operation cannot be canceled.

**6** A message will appear on the display to inform you that the operation has finished.

Press the [EXIT] button to return to the MAIN display.

## Playing Files Located on a USB Flash Memory

### IMPORTANT

• In order to play data copied to a USB flash memory from a computer or other device, the data must be stored either in the USB flash memory's root directory or a first-level/second-level folder in the root directory.

Data stored in third-level-folders created inside a second-level folder cannot be selected and played by this instrument.

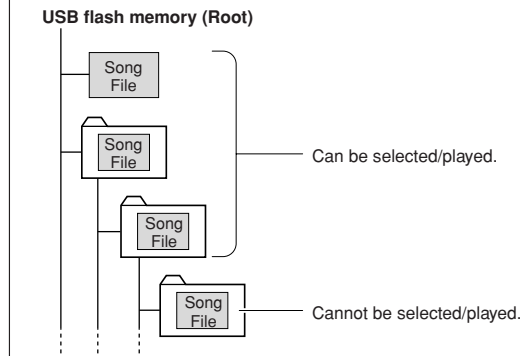

**1** Make sure that the USB flash memory containing the file you want to play has been properly connected to the instrument's USB TO DEVICE terminal, and that the icon is showing in the MAIN display.



**2** Press the [SONG], [STYLE] or [MUSIC DATABASE] button. Files of the corresponding type will be displayed.

**3** Use the dial to select the file you want to play.

**4** Play the selected file in the same way the internal files are played: press the [START/STOP] button, or play on the keyboard.



# Connections

## Connectors

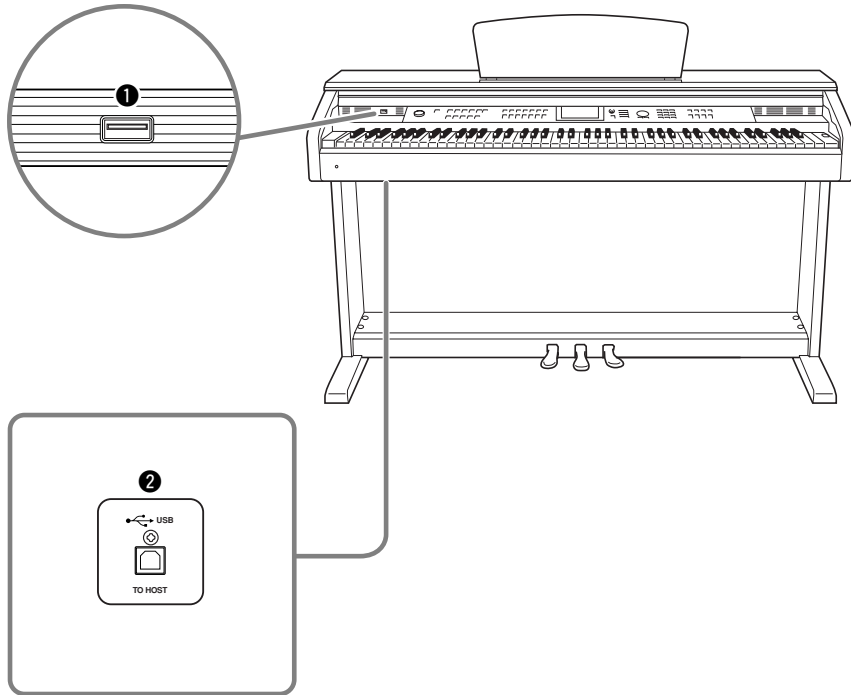

### ❶ USB TO DEVICE terminal

This terminal allows connection to USB storage devices. Refer to “Precautions when using the USB TO DEVICE terminal” on page 96.

### ❷ USB TO HOST terminal

This terminal allows direct connection to a personal computer. Refer to “Connecting a Personal Computer” on page 104 for more information.

## Connecting a Personal Computer

The following functions become available when this instrument is connected to a computer.

- Performance data can be transferred between the instrument and the computer (page 105).
- Files can be transferred between the instrument and the computer (page 107).

The connection procedure is as follows:

### 1 Install the USB-MIDI driver on your computer.

The USB-MIDI driver is included on the CD-ROM. Installation of the USB-MIDI driver is described on the “Accessory CD-ROM Installation Guide”.

### 2 Connect the USB terminal of the computer to the USB terminal on the instrument using an AB type USB cable (USB cable sold separately).

The supplied CD-ROM also includes a Musicsoft Downloader application that allows you to transfer song files from your computer to the instrument’s flash memory. For instructions about how to install Musicsoft Downloader (refer to included “Accessory CD-ROM Installation Guide”) and how to transfer song files (refer to page 107).

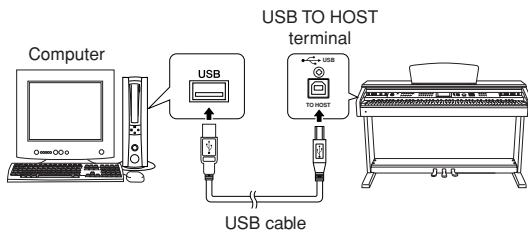

### ■ Precautions when using the USB TO HOST terminal

When connecting the computer to the USB TO HOST terminal, make sure to observe the following points. Failing to do so risks freezing the computer and corrupting or losing the data. If the computer or the instrument freezes, restart the application software or the computer OS, or turn the power to the instrument off then on again.

#### ⚠ CAUTION

- Use an AB type USB cable of less than about 3 meters.
- Before connecting the computer to the USB TO HOST terminal, exit from any power-saving mode of the computer (such as suspended, sleep, standby).
- Before turning on the power to the instrument, connect the computer to the USB TO HOST terminal.
- Execute the following before turning the power to the instrument on/off or plugging/unplugging the USB cable to/from the [USB TO HOST] terminal.
  - Quit any open application software on the computer.
  - Make sure that data is not being transmitted from the instrument. (Data is transmitted whenever you play on the keyboard or play back a song, etc.)
- While the computer is connected to the instrument, you should wait for six seconds or more between these operations:
  - (1) when turning the power of the instrument off then on again,
  - (2) when alternately connecting/disconnecting the USB cable.



## Transferring Performance Data to and from a Computer

By connecting the instrument to a computer, the instrument's performance data can be used on the computer, and performance data from the computer can be played on the instrument.

- When the instrument is connected with computer, it transmits/receives performance data.

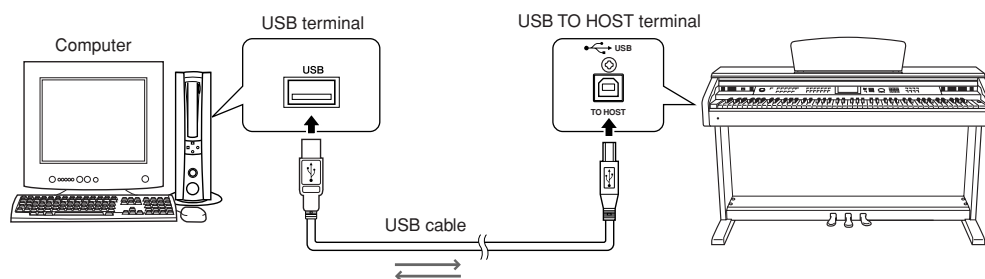

## MIDI settings .....

These settings pertain to performance data transmission and reception.

Item	Range/Settings	Description
Local	ON/OFF	Local control determines whether or not notes played on the instrument are sounded by its internal tone generator system: the internal tone generator is active when local control is on, and inactive when local control is off.
External Clock	ON/OFF	These settings determine whether the instrument is synchronized to its own internal clock (OFF), or to a clock signal from an external device (ON).
Keyboard Out	ON/OFF	These settings determine whether keyboard performance data of the instrument is transmitted (ON) or not (OFF).
Style Out	ON/OFF	These settings determine whether Style data is transmitted (ON) or not (OFF) during Style playback.
Song Out	ON/OFF	These settings determine whether User Song is transmitted (ON) or not (OFF) during Song playback.

### NOTE

- If you can't get any sound out of the instrument, this most likely may be caused by Local Control being set to off.

### NOTE

- If External Clock is ON and no clock signal is being received from an external device, the song, style, and metronome functions will not start.

- 1 Press the [FUNCTION] button.

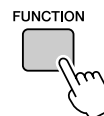

- 2 Use the CATEGORY [▲] and [▼] buttons to select the item you want to change its value.

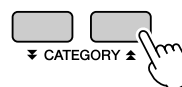

- 3 Use the dial to select ON or OFF.

## ■ PC Mode .....

A number of MIDI settings need to be made when you want to transfer performance data between the computer and the instrument. The PC Mode item can conveniently make multiple settings for you in one operation. Three settings are available: PC1, PC2, and OFF.

This setting is not necessary when transferring song or backup files between the computer and the instrument.

\* Set the PC mode to PC2 when using Digital Music Notebook.

	PC1	PC2*	OFF
Local	OFF	OFF	ON
External Clock	ON	OFF	OFF
Song Out	OFF	OFF	OFF
Style Out	OFF	OFF	OFF
Keyboard Out	OFF	ON	ON

**1** Press and hold the [DEMO] button for longer than a second so that the PC Mode item appears.

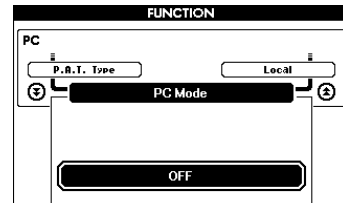
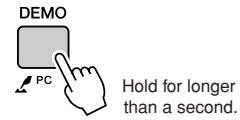

**2** Use the dial to select PC1, PC2, or OFF.

**NOTE**

- When the PC2 setting is selected the instrument's style, song, demo, song recording, and lesson features cannot be used.

**NOTE**

- You can also access the PC Mode item by first pressing the [FUNCTION] button and then using the CATEGORY [▲] and [▼] buttons to locate it (page 92).

## Remote Control of MIDI Devices

You can also use this instrument as a remote control device for the Digital Music Notebook application on your computer (via the USB connection)—controlling playback, stop and transport functions from the panel.

### ■ Remote control keys .....

To use the remote control functions, simultaneously hold down the lowest two keys on the keyboard (A-1 and A#-1) and press the appropriate key (shown below).

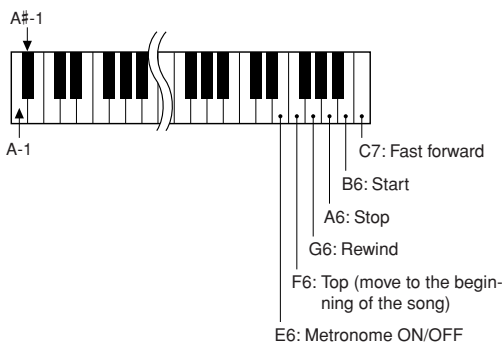

**NOTE**

- Remote control of MIDI devices will function independently of the PC2 mode.

## Initial Send

This function lets you send the panel setup data to a computer. Before you record performance data to a sequencer application running on your computer, it is a good idea to first send and record the panel setup data before the actual performance data.

### 1 Press the [FUNCTION] button.

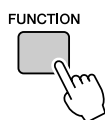

### 2 Use the CATEGORY [▲] and [▼] buttons to select the Initial Send item.

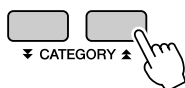

### 3 Press [+ / YES] to send, or press [- / NO] to cancel.

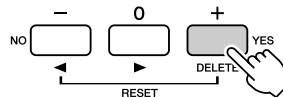

## Transferring Data Between the Computer and Instrument

Songs, styles, or Music Database files residing on a computer or the supplied CD-ROM, can be transferred to the instrument. Backup file can also be transferred from the instrument to the computer and back.

In order to transfer files between your computer and the instrument you will need to install the Musicsoft Downloader application and the USB-MIDI Driver included on the Accessory CD-ROM on your computer. Refer to the included "Accessory CD-ROM Installation Guide" for installation details.

#### ● Data that can be transferred from a computer to this instrument.

- Data Capacity: 1895KB  
502 files total for the Song, Style and Music Database.
- Data Format  
Song: .mid SMF format 0/1  
Style: .sty  
Music Database: .mfd  
Backup File: 09DP88.BUP

#### ● What is SMF (Standard MIDI File)?

The SMF (Standard MIDI File) format is one of the most common and widely compatible sequence formats used for storing sequence data. There are two variations: Format 0 and Format 1. A large number of MIDI devices are compatible with SMF Format 0, and most commercially available MIDI sequence data is provided in SMF Format 0.

#### ■ With the Musicsoft Downloader You Can. . . . .

- Transfer files from the computer to the instrument's flash memory.  
⇒ refer to the procedure described on page 108.  
The procedure for transferring songs included on the Accessory CD-ROM from your computer to the instrument is given as an example.
- Backup file can be transferred from the instrument to a computer and back.  
⇒ refer to the procedure described on page 109.

Use the Musicsoft Downloader application with Internet Explorer 5.5 or higher.

## ■ Use Musicsoft Downloader To Transfer Songs From the Accessory CD-ROM To the Instrument's flash memory.....

**NOTE**

• If a song or style is being played, stop playback before proceeding.

**1** Install the Musicsoft Downloader and USB-MIDI driver to your computer, then connect the computer and the instrument (refer to “Accessory CD-ROM Installation Guide”).

**2** Insert the included CD-ROM into the CD-ROM drive.

A start window will appear automatically.

**3** Double-click the Musicsoft Downloader shortcut icon that is created on the desktop.

This will launch the Musicsoft Downloader application and the main window will appear.

**NOTE**

• The instrument cannot be operated while the Musicsoft Downloader is running.

**4** Click the “Add File” button and the Add File window will appear.

**5** Click the button to the right of “Look in” and select the CD-ROM drive from the drop-down menu that appears. Double-click the “SampleData” Folder on the window. Select the file from the “Song-Data” Folder you want to transfer to the instrument, and click “Open”.

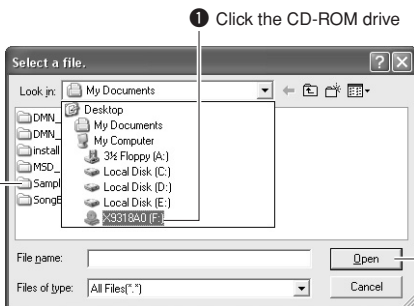

**2** Double-click “SampleData” Folder → “Song-Data” Folder, and click a song file. **3** Click “Open”

At this point you can select a Style or Music Database file on the computer or CD-ROM and transfer it to the instrument in the same way as a song file.

**6** A copy of the selected MIDI song file will appear in the “List of files stored temporarily” at the top of the window.

The memory medium will also be displayed at the bottom of the window to specify the destination for the transfer. Click “Instrument”, and then “Flash memory”.

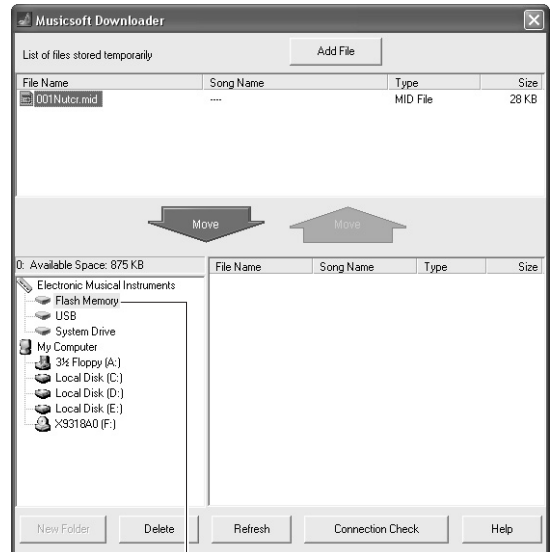

**1** Click the “Electronic Musical Instruments”, and then “Flash Memory”

**7** After selecting the file in the “List of files stored temporarily”, click the downward [Move] button and a confirmation message will appear. Click [OK] and the song will be transferred from the “List of files stored temporarily” to the instrument’s memory.

**NOTE**

• Files transferred to a USB flash memory root directory using the Musicsoft Downloader—any location outside the USER FILES folder on the USB flash memory device—cannot be deleted via the instrument’s file control display. Use the Musicsoft Downloader delete button to delete such files.

## 8 Close the window to end the Musicsoft Downloader.

### NOTE

- End the Musicsoft Downloader to playback the file transferred from your computer.

## 9 To playback a song stored in flash memory, press the [SONG] button. Use the dial to select the song you want to play, then press the [START/STOP] button to start playback.

### CAUTION

- Do not unplug the USB cable during a data transfer. Not only will the data not be transferred and saved, but operation of the memory media may become unstable and its contents may disappear completely when the power is turned on or off.

### CAUTION

- Store data can be lost due to equipment malfunction or improper operation. For safety we recommend that you keep a copy of all important data stored on your computer.

### ● To Use transferred Songs For Lessons...

In order to use songs (only SMF format 0 and 1) transferred from a computer for lessons it is necessary to specify which channels are to be played back as the right-hand and left-hand parts.

- 1 Press the [SONG] button and select the song (036-) residing in flash memory for which you want to set the guide track.
- 2 Press the [FUNCTION] button.
- 3 Use the CATEGORY [ $\blacktriangle$ ] and [ $\blacktriangledown$ ] buttons to select the R-Part or L-Part item.
- 4 Use the dial to select the channel you want to play back as the specified right- or left-hand part.

We recommend that you select channel 1 for the right-hand part and channel 2 for the left-hand part.

## ■ Transfer a Backup file from the instrument to a computer...

You can use the Musicsoft Downloader to transfer “Backup” files containing Registration Memory and FUNCTION settings (page 65) to a computer. If you click “Electronic Musical Instruments” in the Musicsoft Downloader display, and then “System Drive”, a file named “09DP88.BUP” will appear in the lower right corner of the Musicsoft Downloader display. This is the backup file. For details about how to transfer backup files using the Musicsoft Downloader application, refer to the Online help “Transferring Data Between the Computer and Instrument (for unprotected data)” in the application.

### NOTE

- Preset Song data cannot be transmitted from the instrument.

### CAUTION

- The backup file is transmitted/received as a single file. As a result, all registration memory data will be overwritten every time you transmit or receive. Keep this in mind when transferring data.

### CAUTION

- Do not rename the backup file on the computer. If you do so it will not be recognized when transferred to the instrument.



# Troubleshooting

## ■ For the Instrument

Problem	Possible Cause and Solution
When the instrument is turned on or off, a popping sound is temporarily produced.	This is normal and indicates that the instrument is receiving electrical power.
When using a mobile phone, noise is produced.	Using a mobile phone in close proximity to the instrument may produce interference. To prevent this, turn off the mobile phone or use it further away from the instrument.
There is no sound even when the keyboard is played or when a song or style is being played back.	Check that nothing is connected to the [PHONES] jack on the bottom. When a set of headphones is plugged into this jack, no sound is output.
	Check the Local Control on/off. (See page 105.)
	Is the FILE CONTROL display showing? The instrument's keyboard, etc., will not produce any sound while the FILE CONTROL display is showing. Press the [EXIT] button to return to the MAIN display.
Playing keys in the right hand area of the keyboard does not produce any sound.	When using the Dictionary function (page 87), the keys in the right hand area are used only for entering the chord root and type.
The style or song does not play back when the [START/STOP] button is pressed.	Is External Clock set to ON? Make sure External Clock is set to OFF; refer to "External Clock" on page 105.
The style does not sound properly.	Make sure that the Style Volume (page 93) is set to an appropriate level.
	Is the split point set at an appropriate key for the chords you are playing? Set the split point at an appropriate key (page 82). Is the "ACMP" indicator showing in the display? If it is not showing press the [ACMP ON/OFF] button so that it does show.
No rhythm accompaniment plays when the [START/STOP] button is pressed after selecting style number 131 or a style between 143–160 (Pianist).	This is not a malfunction. Style number 131 and style numbers 143–160 (Pianist) have no rhythm parts, so no rhythm will play. The other parts will begin playing when you play a chord in the accompaniment range of the keyboard if style playback is turned on.
Not all of the voices seem to sound, or the sound seems to be cut off.	The instrument is polyphonic up to a maximum of 64 notes. If the Dual voice or Split voice is being used and a style or song is playing back at the same time, some notes/sounds may be omitted (or "stolen") from the accompaniment or song.
The damper pedal has no effect even when damper pedal is pressed.	The pedal cord may not be properly connected. Make sure securely insert the pedal cord into the [PEDAL] jack (page 116).
The sound of the voice changes from note to note.	This is normal. The AWM tone generation method uses multiple recordings (samples) of an instrument across the range of the keyboard; thus, the actual sound of the voice may be slightly different from note to note.
The Demo display is shown in Japanese, and/or there are Japanese characters in the display messages.	Make sure the Language setting in the FUNCTION display is set to English. (See page 16)
The appropriate display does not appear when the [SONG], [EASY SONG ARRANGER], [STYLE], or [VOICE] button is pressed.	Is another display showing? Try pressing the [EXIT] button to return to the MAIN display, and then pressing one of the mentioned buttons.

Problem	Possible Cause and Solution
The wrong notes sound when the keyboard is played.	Perhaps the performance assistant technology is turned on. Press the [PERFORMANCE ASSISTANT] button to turn it off.
The ACMP indicator does not appear when the [ACMP ON/OFF] button is pressed.	Is the [STYLE] button lit? Always press the [STYLE] button first when you are going to use any style-related function.
There is no harmony sound.	The harmony effects (01–26) behave differently according to their type. Types 01–10, 13 function when style playback is on, chords are played in the accompaniment range of the keyboard, and a melody is played in the right-hand range. Types 15–26 will function whether style playback is on or off. For types 23–26 you need to play two notes at the same time.
The “OverCurrent” message is shown in the upper area of the MAIN display and the USB device does not respond.	Communication with the USB device has been shut down because of the overcurrent to the USB device. Disconnect the device from the USB TO DEVICE terminal, then turn on the power of the instrument.



# Messages

LCD Message	Comment
Access error!	Indicates the failure in reading or writing from/to the media or the flash memory.
All Memory Clearing...	Displayed while erasing all data in the flash memory. Never turn the power off during data transmission.
Are you sure?	Confirms whether Song Clear or Track Clear is executed or not.
Backup Clearing...	Displayed while clearing the back-up data in the flash memory.
Cancel	Displayed when the transmission of Initial Send is cancelled.
Can't clear TrackA.	Displayed when a track clear error occurs.
Clearing...	Displayed while executing Song Clear or Track Clear of the user songs.
Com Mode	Displayed when the Musicsoft Downloader is started on the PC connected to the keyboard. This will not be displayed while the instrument is played back.
Completed	Indicates the specified job completion such as data saving and transmission.
Create Directory	Displayed while creating a folder in the Musicsoft Downloader application.
Data Error!	Displayed when the user song contains illegal data.
Delete File	Displayed while deleting a file in the Musicsoft Downloader.
Delete OK ?	Confirms whether the Delete job is executed or not.
Delete Directory	Displayed while deleting a folder in the Musicsoft Downloader.
Deleting...	Displayed while the delete function is engaged.
End	Displayed when the transmission of Initial Send has been completed.
Error!	Displayed when writing has failed.
Exit.	Displayed when the record standby mode is exited because an inappropriate style has been selected during style record standby.
"File information area is not large enough."	Indicates that saving data in the media cannot be executed since the total number of files have become too many.
File is not found.	Indicates there is no file.
"File too large. Loading is impossible."	Indicates that loading file data cannot be executed since the file data is too large.
Flash Clearing...	Displayed while clearing the song or style data transmitted to the internal flash memory.
Format OK ? [EXECUTE]	Confirms whether formatting the media is executed or not.
Formatting...	Displayed while formatting.
Load OK ?	Confirms whether loading is executed or not.
Loading...	Displayed while loading data.
Media is not inserted.	Displayed when accessing the media while it is not inserted.
Media capacity is full.	Displayed when saving data cannot be executed since the media memory becomes full.
Memory Full	Displayed when the internal memory becomes full during song recording.
"MIDI receive buffer overflow."	Displayed when too much MIDI data was received at one time and failed to proceed.
Move File	Displayed while moving a file in the Musicsoft Downloader.
"Now Writing... (Don't turn off the power now, otherwise the data may be damaged.)"	Displayed while writing data in the memory. Never turn the power off while writing. Doing so may result in data loss.



LCD Message	Comment
OverCurrent	Communication with the USB device has been shut down because of the overcurrent to the USB device. Disconnect the device from the USB TO DEVICE terminal, then turn on the power of the instrument.
Overwrite ?	Confirms whether overwriting is executed or not.
Please Wait...	Displayed when executing the jobs that take some time, such as displaying scores and lyrics, or stopping recording.
Rename File	Displayed while rewriting the file name in the Musicsoft Downloader.
Save OK ?	Confirms whether saving is executed or not.
Saved data is not found.	Displayed when the data to be saved doesn't exist.
Saving...	Displayed while saving data in the memory. Never turn the power off while saving. Doing so may result in data loss.
Send OK?	Confirms whether the data transmission is executed or not.
Sending...	Displayed while transmitting data.
"Since the media is in use now, this function is not available."	Indicates that the file control function is currently unavailable since the media is being accessed.
Style data is too large to load.	Indicates that style data cannot be loaded since the style data is too large.
Sure ? [YES/NO]	Reconfirms whether each operation is executed or not.
"The limit of the media has been reached."	Indicates that saving data cannot be executed since the folder/directory structure has become too complicated.
The media is not formatted.	Indicates the inserted media has not been formatted.
"The media is write-protected."	Indicates that the inserted media cannot be written since it is write-protected. Set to the write-protect switch to the "overwrite" position before use.
"The song data is too large to be converted to notation."	Indicates that the score cannot be displayed since the song data is too large.
There are too many files.	Indicates that saving data cannot be executed since the total number of files exceeds the capacity.
"This function is not available now."	Indicates the designated function is not available since the instrument is executing another job.
[nnn] "file name"	Indicates the file name of the currently transmitting. "nnn" indicates the receiving block.

**NOTE**

- Not all the messages are listed in the table: the messages necessary to be explained only.



# Keyboard Stand Assembly

## ⚠ CAUTION

- Be careful not to confuse parts, and be sure to install all parts in the correct direction. Please assemble in accordance with the sequence given below.
- Assembly should be carried out by at least two persons.
- Assemble the stand on a hard and flat floor with ample space.
- Be sure to use the included screws only, and insert screws of the correct size in the correct hole locations. Do not use any other screws. Use of incorrect screws can cause damage or malfunction of the product.
- Be sure to tighten up all screws upon completing assembly of each unit.
- To disassemble, reverse the assembly sequence given below.

Have a Phillips-head (+) screwdriver ready

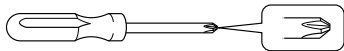

Remove all parts from the package and make sure you have all of the items.

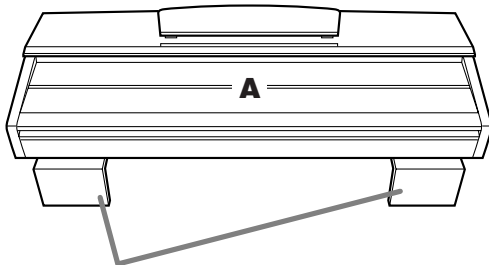

Foamed styrol pads

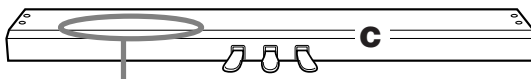

Bundled pedal cord inside

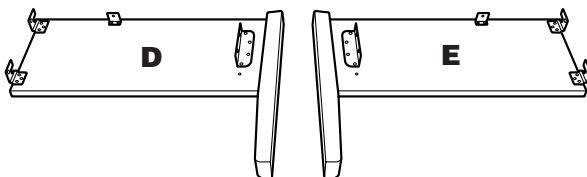

6 x 20 mm long screws (x 4)



6 x 16 mm short screws (x 4)



4 x 12 mm thin screws (x 2)



4 x 20 mm tapping screws (x 4)



4 x 10 mm thin screws (x 2)



AC power cord (x 1)



Headphone hanger (x 1)



Cord holders (x 2)



Adjuster (x 1)

## 1 Attach the adjuster to C.

**1-1** Align the tip of the adjuster with the screw hole, then screw in the adjuster all the way until it stops turning.

You will adjust the height of the adjuster in Step 8.

**1-2** Untie and straighten out the bundled cord. Don't discard the vinyl tie, you'll need it later in Step 7.

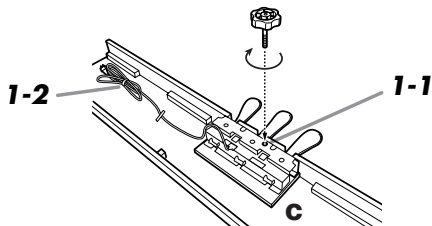

## 2 Attach (finger-tighten) D and E to C.

**2-1** Align D and E with each end of C.

**2-2** Attach D and E to C by finger-tightening the long screws (6 x 20mm).

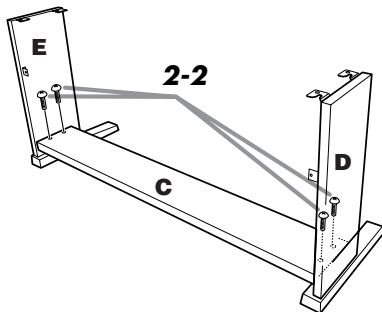

## 3 Attach B.

**3-1** Place the lower side of B on each foot of D and E, then attach the upper side to D and E.

**3-2** Attach the top of B to D and E by finger-tightening the thin screws (4 x 12mm).

**3-3** While pushing the lower outside part of D and E towards each other, secure the bottom of B at each end using two tapping screws (4 x 20mm).

**3-4** Insert the other two tapping screws (4 x 20mm) into the other two screw holes to secure B.

**3-5** While pushing D and E towards each other, securely tighten the screws that were finger-tightened in Step 3-2.

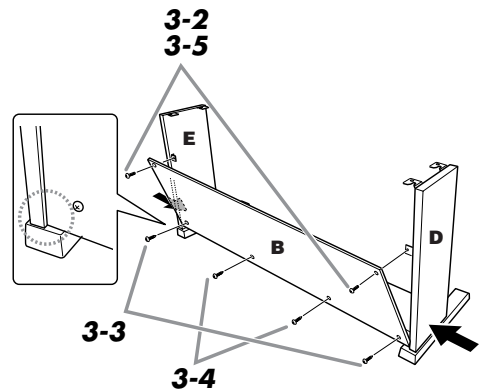

## 4 Secure C.

**4-1** Securely tighten the screws on C that were attached in Step 2-2.

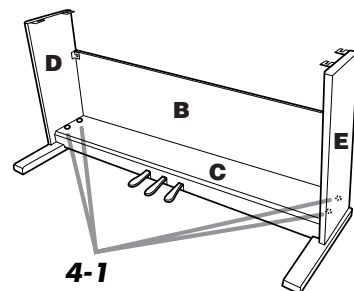

## 5 Mount A.

**5-1** Place your hands at least 15 cm from either end of A when positioning it.

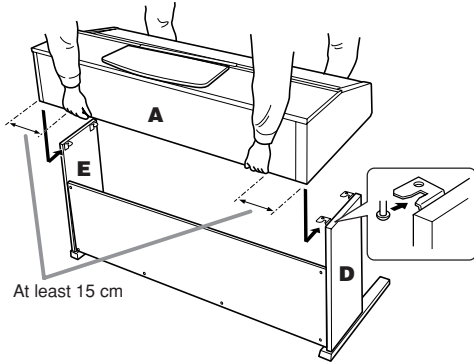

## 6 Secure A.

**6-1** Adjust the position of A so that the left and right ends of A will project beyond D and E equally when seen from the front.

**6-2** Secure A by tightening the short screws (6 x 16mm) from the front.

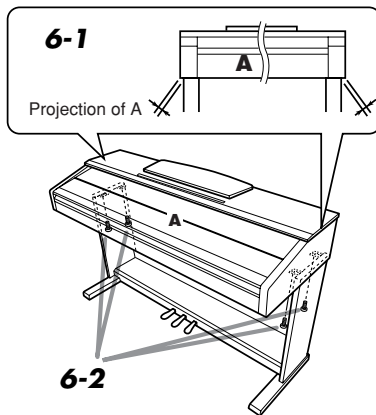

## 7 Connect the pedal cord and the power cord.

**7-1** Insert the pedal cord plug to the pedal connector from the rear.

**7-2** Attach the cord holders to B, then clip the cord into the holders.

**7-3** Use a vinyl tie to bundle the pedal cord.

**7-4** For models that feature a voltage selector: Set the voltage selector to an appropriate voltage.

### Voltage Selector

Before connecting the AC power cord, check the setting of the voltage selector which is provided in some areas. To set the selector for 110V, 127V, 220V or 240V main voltages, use a “minus” screwdriver to rotate the selector dial so that the correct voltage for your region appears next to the pointer on the panel. The voltage selector is set at 240V when the unit is initially shipped. After the proper voltage has been selected, connect the AC power cord to the AC INLET and an AC wall outlet. A plug adaptor may be also provided in some areas to match the pin configuration of the AC wall outlets in your area.

### **⚠ WARNING**

• An improper voltage setting can cause serious damage to this instrument or result in improper operation.

**7-5** Insert the AC power cord plug into the AC INLET.

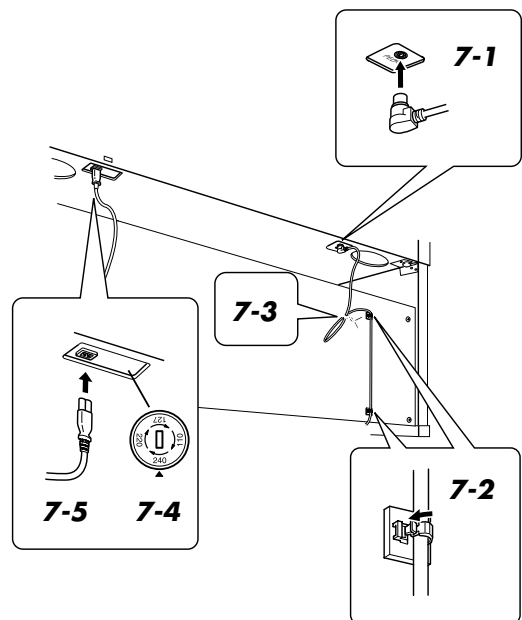

## 8 Set the adjuster.

**8-1** Rotate the adjuster until it comes in firm contact with the floor surface.

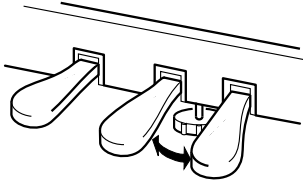

## 9 Attach the headphone hanger.

**9-1** Install the headphone hanger using included two screws (4 x 10mm) as shown in the figure.

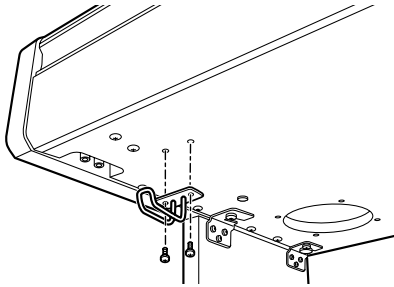

## Remove the protective tapes

Open the key cover and remove the protective tape on each side of the keyboard.

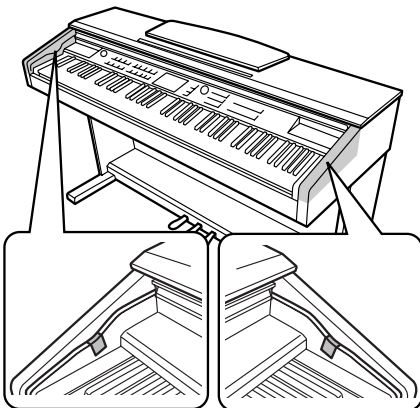

## After completing the assembly, please check the following.

- Are there any parts left over?  
→ Review the assembly procedure and correct any errors.
- Is this instrument clear of doors and other movable fixtures?  
→ Move the instrument to an appropriate location.
- Does this instrument make a rattling noise when you shake it?  
→ Tighten all screws.
- Does the pedal box rattle or give way when you step on the pedals?  
→ Turn the adjuster so that it is set firmly against the floor.
- Are the pedal and power cords inserted securely into the sockets?  
→ Check the connection.
- If the main unit creaks or is otherwise unsteady when you play on the keyboard, refer to the assembly diagrams and retighten all screws.

### **CAUTION**

- *When moving the instrument after assembly, always hold the bottom of the main unit. Do not hold the key cover or top portion. Improper handling can result in damage to the instrument or personal injury.*

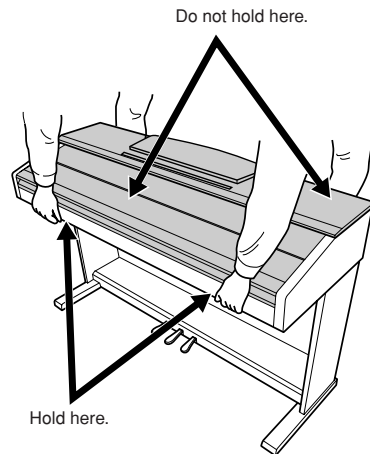



# Index

## Panel controls and terminals

+/-	15, 67
	68
0-9	15, 67
A-B REPEAT	15, 88
ACMP ON/OFF	15, 27
CATEGORY [] and []	15, 67
DEMO	15, 32
Dial	15, 67
DSP ON/OFF	15, 73
DUAL ON/OFF	15, 18
EASY SONG ARRANGER	15, 58
EXECUTE	15, 97
EXIT	15, 68
FF	15, 34
FILE CONTROL	15, 95
FUNCTION	15, 92
HARMONY ON/OFF	15, 70
INTRO/ENDING/rit.	15, 79
LCD CONTRAST	69
LESSON L, R	15, 51
LESSON START	15, 50
LYRICS	15, 38
MAIN/AUTO FILL	15, 79
MASTER VOLUME	15
MEMORY/BANK, 1, 2	15, 90
MENU	15, 95
METRONOME ON/OFF	15, 23
MUSIC DATABASE	15, 57
P.A.T. ON/OFF	15, 40, 48
PAUSE	15, 34
PC	106
PEDAL	15
PHONES	15
PIANO RESET	15, 20
REC, 1-5, A	15, 60
REGIST. MEMORY	15, 90
REPEAT & LEARN	15, 56
REW	15, 34
SCORE	15, 37
SONG	15, 33
SONG MEMORY	15, 61
SPLIT ON/OFF	15, 19
STANDBY/ON	15
START/STOP	15, 67
STYLE	15, 26-30, 79
SYNC START	15, 27, 80
SYNC STOP	15, 81
TEMPO/TAP	15, 23, 34, 75
USB TO DEVICE	15, 103
USB TO HOST	15, 104
VOICE	15, 17

## Alphabetical order

### A

A-B Repeat	88
Accessories	7
ACMP	27
Auto Accompaniment Range	27
Auto-Accompaniment	27, 29, 31

### B

Backup	65, 109
Bell	25

### C

CD-ROM	144
Chord	29-31, 84-85
Chord Dictionary	87
Chord Fingering	31, 86
Chord root	87
Chord type (Chord Dictionary)	87
Chord type (performance assistant technology)	39-40
Chord/Free type (performance assistant technology)	39, 42
Chord/Melody type (performance assistant technology)	39, 46
Chorus	72
Chorus Type	139
Computer	104-105, 107

### D

Default Setting	92
Delete (Song Track)	64
Delete (USB flash memory)	101
Delete (User Data)	102
Delete (User Song)	63
Demo	32
Demo Cancel	94
Display	68-69
Double-Staff Score	37
Drum Kit	22
Drum Kit List	132
DSP	73
DSP Type	73, 140
Dual Chorus Level	93
Dual Octave	93
Dual Pan	93
Dual Reverb Level	93
Dual Voice	18
Dual Volume	93

### E

Easy Chords	31
Easy Song Arranger	58
Effect Type List	138
External Clock	94, 105
External Song	36

### F

File Control	95
File Name	98
Flash Memory	36
Format (File Control)	97
Function	68, 92-94
Function Display	68

### G

Grade	53
-------	----

### H

Harmony	70
Harmony Type	138
Harmony Volume	94
Headphones	12

### I

Initial Send	107
Initialization	65

### K

Keyboard Out	94, 105
Keyboard Stand Assembly	114

### L

Language	16
Lesson	50
Load	100
Local	94, 105
L-Part	94, 109
Lyric	38

### M

Main Chorus Level	93
MAIN Display	68
Main Octave	93
Main Pan	93
Main Reverb Level	93
Main Voice	17
Main Volume	93
Measure	69
Melody	37, 49

- Melody Score ..... 37
- Melody type (performance assistant technology) ..... 39, 44
- Melody Voice ..... 59, 89
- Messages ..... 112
- Metronome ..... 23
- MIDI ..... 105
- MIDI Data Format ..... 7
- MIDI Implementation Chart ..... 7
- Music Database ..... 57
- Music Rest ..... 10
- Mute ..... 89
- N**
- notation ..... 69
- O**
- One Touch Setting ..... 76
- P**
- P.A.T. Type ..... 39, 94
- PC Mode ..... 106
- Pedal ..... 21
- performance assistant technology ..... 39
- Preset Song ..... 32, 35–36
- Q**
- Quantize ..... 94
- R**
- Recording ..... 60
- Registration Memory ..... 90
- Remote control ..... 106
- Repeat ..... 56, 88
- Reverb ..... 71
- Reverb Type ..... 138
- R-Part ..... 94, 109
- S**
- Save (User File) ..... 98
- Save (User Song) ..... 99
- Score ..... 37, 49, 120
- Single-Staff Score ..... 37
- SMF (Standard MIDI File) ..... 107
- Song ..... 33
- Song Clear ..... 63
- Song List ..... 35
- Song Memory ..... 60–61
- Song Out ..... 94, 105
- Song Volume ..... 88
- Sound Type ..... 77, 93
- Specifications ..... 144
- Split Chorus Level ..... 93
- Split Octave ..... 93
- Split Pan ..... 93
- Split Point ..... 19, 82
- Split Reverb Level ..... 93
- Split Voice ..... 19
- Split Volume ..... 93
- Standard Chords ..... 31
- Style ..... 26, 29, 79
- Style File ..... 100
- Style List ..... 134
- Style Out ..... 94, 105
- Style Volume ..... 83
- Sustain ..... 74, 93
- Synchro Start ..... 27, 80
- Synchro Stop ..... 81
- T**
- Tempo ..... 34, 75
- TimeSignature  
(Denominator, Numerator) ..... 24
- Touch Response ..... 75
- Touch Sensitivity ..... 75
- Track ..... 60
- Track Clear ..... 64
- Transfer ..... 105, 107
- Transpose ..... 78
- Troubleshooting ..... 110
- Tuning ..... 78
- U**
- USB ..... 103
- USB-MIDI driver ..... 11
- User file ..... 98, 100
- User File Save ..... 98
- User Song ..... 36, 60
- V**
- Voice ..... 17
- Voice List ..... 126
- X**
- XF ..... 6, 38
- XGlite ..... 6



# Scores / Noten / Partitions / Partituras

This demo is an example of how the Easy Song Arranger can be used to change styles throughout a piece.

Song No. 9

♩ = 123

(Function Demo for Easy Song Arranger)

## Hallelujah Chorus

**Intro**

Melody:  $\overset{1}{\text{A}}$  D G/D D

Style Progression: *<Clubdance>* **Main** **Fill** *1st time* **Main** *2nd time* *<Hard Rock>* **Main**

Melody:  $\overset{5/23}{\text{D}}$  G/D D G/D D G/D D A7 D A D/A A

Style Progression: **Fill** **Main** **Fill** **Main**

Melody:  $\overset{9/27}{\text{A}}$  D/A A D/A A D/A A D A/C# E7/B A **B** A A/G

Style Progression: **Fill** *<Disco Philly>* **Main** **Fill** *<Rumba Flamenco>* **Main**

Melody:  $\overset{13/31}{\text{D/F\#}}$  Bm7 E7sus4 E7 A D/A A D/A A D/A A D/A A

Style Progression: **Fill** *<Bluegrass>* **Main** **Fill**



17/35

D D/C G/B Em7 A7sus4 A7 D G/D D G/D D

**Main**

<Tango> **Main** **Fill** <Fun 4/4> **Main**

21/39

G/D D G/D D CD<sub>8va</sub> G/D D D G/D D

**Fill**

**Fill** <Dream Dance> **Main**

42

G/D D G/D D A7 D D

(8va)

**Fill** **Ending**

10

This score is provided with the intent that the pitch will be corrected by the performance assistant technology feature. If you play the “Play These Notes” part using the performance assistant technology feature, the part will be corrected and played so that it matches the backing part.

Song No. 10

♩ = 61

(Function Demo for performance assistant technology)

### Ave Maria

Melody

Play These Notes

P.A.T. Chord Symbols

These Notes Will Sound

Turn **P.A.T.** ON  
Type = CHORD

5

Your Turn.

Repeatedly Play the Same Key.

C + Dm7/C + G7/B + C

9

Am/C + D7/C + G/B + CM7/B

13

Am7 + D7 + G

This score is provided with the intent that the pitch will be corrected by the performance assistant technology feature. If you play the “Play These Notes” part using the performance assistant technology feature, the part will be corrected and played so that it matches the backing part.

Song No. 11

♩ = 108

(Function Demo for performance assistant technology)

### Nocturne op.9-2

Turn **(P.A.T.) ON**  
Type = CHORD/FREE  
*2nd time only*

1/5

Play These Notes

P.A.T. Chord Symbols

These Left-hand Notes Will Sound

9/25

You Can Even Play the Same Keys!

F + B<sup>b</sup>m/F + F + Am/E + D7

14/30

D7 + Am<sup>b</sup>7/G + Gm + C7 + A7/C<sup>#</sup>

19/35

Dm + Bdim7 + C7sus4 + C7

23

1. 2.

F + F + F + F + F

42

*rit.*

F + F + F + F + F



● Panel Voice List / Verzeichnis der Bedientfeld-Voices / Liste des voix de panneau / Lista de voces del panel

Voice No.	Bank Select		MIDI Program Change# (1-128)	Voice Name
	MSB (0-127)	LSB (0-127)		
<b>PIANO</b>				
001	000	122	001	Natural! Grand
002	000	113	001	Live! Grand Piano
003	000	114	001	Live! Warm Grand Piano
004	000	112	001	Grand Piano
005	000	112	002	Bright Piano
006	000	112	007	Harpsichord
007	000	112	004	Honky-tonk Piano
008	000	112	003	MIDI Grand Piano
009	000	113	003	CP 80
<b>E.PIANO</b>				
010	000	114	005	Cool! Galaxy Electric Piano
011	000	118	005	Cool! Suitcase Electric Piano
012	000	119	005	Cool! Electric Piano
013	000	120	005	Phase Electric Piano
014	000	113	006	Hyper Tines
015	000	112	005	Funky Electric Piano
016	000	112	006	DX Modern Electric Piano
017	000	114	006	Venus Electric Piano
018	000	113	005	Tremolo Electric Piano
019	000	114	008	E.Clavichord
020	000	112	008	Clavi
021	000	113	008	WahClavi
<b>ORGAN</b>				
022	000	118	019	Cool! Organ
023	000	117	019	Cool! Rotor Organ
024	000	112	017	Jazz Organ 1
025	000	113	017	Jazz Organ 2
026	000	112	019	Rock Organ
027	000	114	019	Purple Organ
028	000	112	018	Click Organ
029	000	116	017	Bright Organ
030	000	127	019	Theater Organ
031	000	121	020	16'+2' Organ
032	000	120	020	16'+4' Organ
033	000	113	020	Chapel Organ
034	000	112	020	Church Organ
035	000	112	021	Reed Organ
<b>ACCORDION</b>				
036	000	112	022	Musette Accordion
037	000	113	022	Traditional Accordion
038	000	113	024	Bandoneon
039	000	113	023	Modern Harp
040	000	112	023	Harmonica
<b>GUITAR</b>				
041	000	112	025	Classical Guitar
042	000	112	026	Folk Guitar
043	000	112	027	Jazz Guitar
044	000	117	028	60's Clean Guitar
045	000	113	026	12Strings Guitar
046	000	112	028	Clean Guitar
047	000	113	027	Octave Guitar
048	000	112	029	Muted Guitar
049	000	112	030	Overdriven Guitar
050	000	112	031	Distortion Guitar
<b>BASS</b>				
051	000	112	034	Finger Bass
052	000	112	033	Acoustic Bass
053	000	112	035	Pick Bass
054	000	112	036	Fretless Bass
055	000	112	037	Slap Bass
056	000	112	039	Synth Bass
057	000	113	039	Hi-Q Bass
058	000	113	040	Dance Bass

Voice No.	Bank Select		MIDI Program Change# (1-128)	Voice Name
	MSB (0-127)	LSB (0-127)		
<b>STRINGS</b>				
059	000	116	050	Live! Orchestra
060	000	112	049	String Ensemble
061	000	112	050	Chamber Strings
062	000	113	050	Slow Strings
063	000	112	045	Tremolo Strings
064	000	112	051	Synth Strings
065	000	112	046	Pizzicato Strings
066	000	112	041	Violin
067	000	112	043	Cello
068	000	112	044	Contrabass
069	000	112	047	Harp
070	000	112	106	Banjo
071	000	112	056	Orchestra Hit
<b>CHOIR</b>				
072	000	112	053	Choir
073	000	113	053	Vocal Ensemble
074	000	112	055	Air Choir
075	000	112	054	Vox Humana
<b>SAXOPHONE</b>				
076	000	117	067	Sweet! Tenor Sax
077	000	113	065	Sweet! Soprano Sax
078	000	114	072	Sweet! Clarinet
079	000	118	067	Growl Sax
080	000	112	067	Tenor Sax
081	000	112	066	Alto Sax
082	000	112	065	Soprano Sax
083	000	112	068	Baritone Sax
084	000	114	067	Breathy Tenor Sax
085	000	112	072	Clarinet
086	000	112	069	Oboe
087	000	112	070	English Horn
088	000	112	071	Bassoon
<b>TRUMPET</b>				
089	000	115	057	Sweet! Trumpet
090	000	117	058	Sweet! Trombone
091	000	114	060	Sweet! Muted Trumpet
092	000	112	057	Trumpet
093	000	112	058	Trombone
094	000	113	058	Trombone Section
095	000	112	060	Muted Trumpet
096	000	112	061	French Horn
097	000	112	059	Tuba
<b>BRASS</b>				
098	000	112	062	Brass Section
099	000	113	062	Big Band Brass
100	000	113	063	80's Brass
101	000	119	062	Mellow Horns
102	000	114	063	Techno Brass
103	000	112	063	Synth Brass
<b>FLUTE</b>				
104	000	114	074	Sweet! Flute
105	000	113	076	Sweet! Pan Flute
106	000	112	074	Flute
107	000	112	073	Piccolo
108	000	112	076	Pan Flute
109	000	112	075	Recorder
110	000	112	080	Ocarina
<b>SYNTH LEAD</b>				
111	000	112	081	Square Lead
112	000	112	082	Sawtooth Lead
113	000	115	082	Analogon
114	000	119	082	Fargo
115	000	112	099	Star Dust
116	000	112	086	Voice Lead
117	000	112	101	Brightness

Voice No.	Bank Select		MIDI Program Change# (1-128)	Voice Name
	MSB (0-127)	LSB (0-127)		
<b>SYNTH PAD</b>				
118	000	118	089	SweetHeaven
119	000	112	092	Xenon Pad
120	000	112	095	Equinox
121	000	112	089	Fantasia
122	000	113	090	Dark Moon
123	000	113	101	Bell Pad
<b>PERCUSSION</b>				
124	000	112	012	Vibraphone
125	000	112	013	Marimba
126	000	112	014	Xylophone
127	000	112	115	Steel Drums
128	000	112	009	Celesta
129	000	112	011	Music Box
130	000	112	015	Tubular Bells
131	000	112	048	Timpani
<b>DRUM KITS</b>				
132	127	000	001	Standard Kit 1
133	127	000	002	Standard Kit 2
134	127	000	009	Room Kit
135	127	000	017	Rock Kit
136	127	000	025	Electronic Kit
137	127	000	026	Analog Kit
138	127	000	113	Dance Kit
139	127	000	033	Jazz Kit
140	127	000	041	Brush Kit
141	127	000	049	Symphony Kit
142	126	000	001	SFX Kit 1
143	126	000	002	SFX Kit 2

● **XGLite Voice/XGLite Optional Voice\* List / Liste der XGLite-Voices/optionale XGLite-Voices\* / Voix XGLite/liste des voix\* XGLite en option / Lista de voces de XGLite/voces opcionales de XGLite\***

Voice No.	Bank Select		MIDI Program Change# (1-128)	Voice Name
	MSB (0-127)	LSB (0-127)		
<b>XG PIANO</b>				
144	000	000	001	Grand Piano
145	000	001	001	Grand Piano KSP
146	000	040	001	Piano Strings
147	000	041	001	Dream
148	000	000	002	Bright Piano
149	000	001	002	Bright Piano KSP
150	000	000	003	Electric Grand Piano
151	000	001	003	Electric Grand Piano KSP
152	000	032	003	Detuned CP80
153	000	000	004	Honky-tonk Piano
154	000	001	004	Honky-tonk Piano KSP
155	000	000	005	Electric Piano 1
156	000	001	005	Electric Piano 1 KSP
157	000	032	005	Chorus Electric Piano 1
158	000	000	006	Electric Piano 2
*159	000	001	006	Electric Piano 2 KSP
160	000	032	006	Chorus Electric Piano 2
161	000	041	006	DX + Analog Electric Piano
162	000	000	007	Harpsichord
163	000	001	007	Harpsichord KSP
164	000	035	007	Harpsichord 2
165	000	000	008	Clavi
166	000	001	008	Clavi KSP
<b>XG CHROMATIC</b>				
167	000	000	009	Celesta
168	000	000	010	Glockenspiel
169	000	000	011	Music Box
170	000	064	011	Orgel
171	000	000	012	Vibraphone
172	000	001	012	Vibraphone KSP
173	000	000	013	Marimba
174	000	001	013	Marimba KSP
175	000	064	013	Sine Marimba
176	000	097	013	Balimba
177	000	098	013	Log Drums
178	000	000	014	Xylophone
179	000	000	015	Tubular Bells
180	000	096	015	Church Bells
181	000	097	015	Carillon
182	000	000	016	Dulcimer
183	000	035	016	Dulcimer 2
184	000	096	016	Cimbalom
185	000	097	016	Santur
<b>XG ORGAN</b>				
186	000	000	017	Drawbar Organ
187	000	032	017	Detuned Drawbar Organ
188	000	033	017	60's Drawbar Organ 1
189	000	034	017	60's Drawbar Organ 2
190	000	035	017	70's Drawbar Organ 1
191	000	037	017	60's Drawbar Organ 3
192	000	040	017	16+2'2/3
193	000	064	017	Organ Bass
194	000	065	017	70's Drawbar Organ 2
195	000	066	017	Cheezy Organ
196	000	067	017	Drawbar Organ 2
197	000	000	018	Percussive Organ
198	000	024	018	70's Percussive Organ
199	000	032	018	Detuned Percussive Organ
200	000	033	018	Light Organ
201	000	037	018	Percussive Organ 2
202	000	000	019	Rock Organ



Voice No.	Bank Select		MIDI Program Change# (1-128)	Voice Name
	MSB (0-127)	LSB (0-127)		
203	000	064	019	Rotary Organ
204	000	065	019	Slow Rotary
205	000	066	019	Fast Rotary
206	000	000	020	Church Organ
207	000	032	020	Church Organ 3
208	000	035	020	Church Organ 2
209	000	040	020	Notre Dame
210	000	064	020	Organ Flute
211	000	065	020	Tremolo Organ Flute
212	000	000	021	Reed Organ
213	000	040	021	Puff Organ
214	000	000	022	Accordion
215	000	000	023	Harmonica
216	000	032	023	Harmonica 2
217	000	000	024	Tango Accordion
218	000	064	024	Tango Accordion 2
<b>XG GUITAR</b>				
219	000	000	025	Nylon Guitar
220	000	043	025	Velocity Guitar Harmonics
221	000	096	025	Ukulele
222	000	000	026	Steel Guitar
223	000	035	026	12-string Guitar
224	000	040	026	Nylon & Steel Guitar
225	000	041	026	Steel Guitar with Body Sound
226	000	096	026	Mandolin
227	000	000	027	Jazz Guitar
228	000	032	027	Jazz Amp
229	000	000	028	Clean Guitar
230	000	032	028	Chorus Guitar
231	000	000	029	Muted Guitar
232	000	040	029	Funk Guitar
233	000	041	029	Muted Steel Guitar
234	000	045	029	Jazz Man
235	000	000	030	Overdriven Guitar
236	000	043	030	Guitar Pinch
237	000	000	031	Distortion Guitar
238	000	040	031	Feedback Guitar
239	000	041	031	Feedback Guitar 2
240	000	000	032	Guitar Harmonics
241	000	065	032	Guitar Feedback
242	000	066	032	Guitar Harmonics 2
<b>XG BASS</b>				
243	000	000	033	Acoustic Bass
244	000	040	033	Jazz Rhythm
245	000	045	033	Velocity Crossfade Upright Bass
246	000	000	034	Finger Bass
247	000	018	034	Finger Dark
248	000	040	034	Bass & Distorted Electric Guitar
249	000	043	034	Finger Slap Bass
250	000	045	034	Finger Bass 2
251	000	065	034	Modulated Bass
252	000	000	035	Pick Bass
253	000	028	035	Muted Pick Bass
254	000	000	036	Fretless Bass
255	000	032	036	Fretless Bass 2
256	000	033	036	Fretless Bass 3
257	000	034	036	Fretless Bass 4
258	000	000	037	Slap Bass 1
259	000	032	037	Punch Thumb Bass
260	000	000	038	Slap Bass 2
261	000	043	038	Velocity Switch Slap
262	000	000	039	Synth Bass 1
263	000	040	039	Techno Synth Bass
264	000	000	040	Synth Bass 2
265	000	006	040	Mellow Synth Bass
266	000	012	040	Sequenced Bass
267	000	018	040	Click Synth Bass

Voice No.	Bank Select		MIDI Program Change# (1-128)	Voice Name
	MSB (0-127)	LSB (0-127)		
*268	000	019	040	Synth Bass 2 Dark
269	000	040	040	Modular Synth Bass
270	000	041	040	DX Bass
<b>XG STRINGS</b>				
271	000	000	041	Violin
272	000	008	041	Slow Violin
273	000	000	042	Viola
274	000	000	043	Cello
275	000	000	044	Contrabass
276	000	000	045	Tremolo Strings
277	000	008	045	Slow Tremolo Strings
278	000	040	045	Suspense Strings
279	000	000	046	Pizzicato Strings
280	000	000	047	Orchestral Harp
281	000	040	047	Yang Chin
282	000	000	048	Timpani
<b>XG ENSEMBLE</b>				
283	000	000	049	Strings 1
284	000	003	049	Stereo Strings
285	000	008	049	Slow Strings
286	000	035	049	60's Strings
287	000	040	049	Orchestra
288	000	041	049	Orchestra 2
289	000	042	049	Tremolo Orchestra
290	000	045	049	Velocity Strings
291	000	000	050	Strings 2
292	000	003	050	Stereo Slow Strings
293	000	008	050	Legato Strings
294	000	040	050	Warm Strings
295	000	041	050	Kingdom
296	000	000	051	Synth Strings 1
297	000	000	052	Synth Strings 2
298	000	000	053	Choir Aahs
299	000	003	053	Stereo Choir
300	000	032	053	Mellow Choir
301	000	040	053	Choir Strings
302	000	000	054	Voice Oohs
303	000	000	055	Synth Voice
304	000	040	055	Synth Voice 2
305	000	041	055	Choral
306	000	064	055	Analog Voice
307	000	000	056	Orchestra Hit
308	000	035	056	Orchestra Hit 2
309	000	064	056	Impact
<b>XG BRASS</b>				
310	000	000	057	Trumpet
311	000	032	057	Warm Trumpet
312	000	000	058	Trombone
313	000	018	058	Trombone 2
314	000	000	059	Tuba
315	000	000	060	Muted Trumpet
316	000	000	061	French Horn
317	000	006	061	French Horn Solo
318	000	032	061	French Horn 2
319	000	037	061	Horn Orchestra
320	000	000	062	Brass Section
321	000	035	062	Trumpet & Trombone Section
322	000	000	063	Synth Brass 1
323	000	020	063	Resonant Synth Brass
324	000	000	064	Synth Brass 2
325	000	018	064	Soft Brass
326	000	041	064	Choir Brass
<b>XG REED</b>				
327	000	000	065	Soprano Sax
328	000	000	066	Alto Sax
329	000	040	066	Sax Section
330	000	000	067	Tenor Sax

Voice List / Voice-Liste / Liste des voix / Lista de voces

Voice No.	Bank Select		MIDI Program Change# (1-128)	Voice Name
	MSB (0-127)	LSB (0-127)		
331	000	040	067	Breathy Tenor Sax
332	000	000	068	Baritone Sax
333	000	000	069	Oboe
334	000	000	070	English Horn
335	000	000	071	Bassoon
336	000	000	072	Clarinet
<b>XG PIPE</b>				
337	000	000	073	Piccolo
338	000	000	074	Flute
339	000	000	075	Recorder
340	000	000	076	Pan Flute
341	000	000	077	Blown Bottle
342	000	000	078	Shakuhachi
343	000	000	079	Whistle
344	000	000	080	Ocarina
<b>XG SYNTH LEAD</b>				
345	000	000	081	Square Lead
346	000	006	081	Square Lead 2
347	000	008	081	LM Square
348	000	018	081	Hollow
349	000	019	081	Shroud
350	000	064	081	Mellow
351	000	065	081	Solo Sine
352	000	066	081	Sine Lead
353	000	000	082	Sawtooth Lead
354	000	006	082	Sawtooth Lead 2
355	000	008	082	Thick Sawtooth
356	000	018	082	Dynamic Sawtooth
357	000	019	082	Digital Sawtooth
358	000	020	082	Big Lead
359	000	096	082	Sequenced Analog
360	000	000	083	Calliope Lead
361	000	065	083	Pure Lead
362	000	000	084	Chiff Lead
363	000	000	085	Charang Lead
364	000	064	085	Distorted Lead
365	000	000	086	Voice Lead
366	000	000	087	Fifths Lead
367	000	035	087	Big Five
368	000	000	088	Bass & Lead
369	000	016	088	Big & Low
370	000	064	088	Fat & Perky
371	000	065	088	Soft Whirl
<b>XG SYNTH PAD</b>				
372	000	000	089	New Age Pad
373	000	064	089	Fantasy
374	000	000	090	Warm Pad
375	000	000	091	Poly Synth Pad
376	000	000	092	Choir Pad
377	000	066	092	Itopia
378	000	000	093	Bowed Pad
379	000	000	094	Metallic Pad
380	000	000	095	Halo Pad
381	000	000	096	Sweep Pad
<b>XG SYNTH EFFECTS</b>				
382	000	000	097	Rain
383	000	065	097	African Wind
384	000	066	097	Carib
385	000	000	098	Sound Track
386	000	027	098	Prologue
387	000	000	099	Crystal
388	000	012	099	Synth Drum Comp
389	000	014	099	Popcorn
390	000	018	099	Tiny Bells
391	000	035	099	Round Glockenspiel
392	000	040	099	Glockenspiel Chimes
393	000	041	099	Clear Bells

Voice No.	Bank Select		MIDI Program Change# (1-128)	Voice Name
	MSB (0-127)	LSB (0-127)		
394	000	042	099	Chorus Bells
395	000	065	099	Soft Crystal
396	000	070	099	Air Bells
397	000	071	099	Bell Harp
398	000	072	099	Gamelimba
399	000	000	100	Atmosphere
400	000	018	100	Warm Atmosphere
401	000	019	100	Hollow Release
402	000	040	100	Nylon Electric Piano
403	000	064	100	Nylon Harp
404	000	065	100	Harp Vox
405	000	066	100	Atmosphere Pad
406	000	000	101	Brightness
407	000	000	102	Goblins
408	000	064	102	Goblins Synth
409	000	065	102	Creeper
410	000	067	102	Ritual
411	000	068	102	To Heaven
412	000	070	102	Night
413	000	071	102	Glisten
414	000	096	102	Bell Choir
415	000	000	103	Echoes
416	000	000	104	Sci-Fi
<b>XG WORLD</b>				
417	000	000	105	Sitar
418	000	032	105	Detuned Sitar
419	000	035	105	Sitar 2
420	000	097	105	Tamboura
421	000	000	106	Banjo
422	000	028	106	Muted Banjo
423	000	096	106	Rabab
424	000	097	106	Gopichant
425	000	098	106	Oud
426	000	000	107	Shamisen
427	000	000	108	Koto
428	000	096	108	Taisho-kin
429	000	097	108	Kanoon
430	000	000	109	Kalimba
431	000	000	110	Bagpipe
432	000	000	111	Fiddle
433	000	000	112	Shanai
<b>XG PERCUSSIVE</b>				
434	000	000	113	Tinkle Bell
435	000	096	113	Bonang
436	000	097	113	Altair
437	000	098	113	Gamelan Gongs
438	000	099	113	Stereo Gamelan Gongs
439	000	100	113	Rama Cymbal
440	000	000	114	Agogo
441	000	000	115	Steel Drums
442	000	097	115	Glass Percussion
443	000	098	115	Thai Bells
444	000	000	116	Woodblock
445	000	096	116	Castanets
446	000	000	117	Taiko Drum
447	000	096	117	Gran Cassa
448	000	000	118	Melodic Tom
449	000	064	118	Melodic Tom 2
450	000	065	118	Real Tom
451	000	066	118	Rock Tom
452	000	000	119	Synth Drum
453	000	064	119	Analog Tom
454	000	065	119	Electronic Percussion
455	000	000	120	Reverse Cymbal
<b>XG SOUND EFFECTS</b>				
456	000	000	121	Fret Noise
457	000	000	122	Breath Noise

Voice No.	Bank Select		MIDI Program Change# (1-128)	Voice Name
	MSB (0-127)	LSB (0-127)		
458	000	000	123	Seashore
459	000	000	124	Bird Tweet
460	000	000	125	Telephone Ring
461	000	000	126	Helicopter
462	000	000	127	Applause
463	000	000	128	Gunshot
464	064	000	001	Cutting Noise
465	064	000	002	Cutting Noise 2
466	064	000	004	String Slap
467	064	000	017	Flute Key Click
468	064	000	033	Shower
469	064	000	034	Thunder
470	064	000	035	Wind
471	064	000	036	Stream
472	064	000	037	Bubble
473	064	000	038	Feed
474	064	000	049	Dog
475	064	000	050	Horse
476	064	000	051	Bird Tweet 2
477	064	000	056	Maou
478	064	000	065	Phone Call
479	064	000	066	Door Squeak
480	064	000	067	Door Slam
481	064	000	068	Scratch Cut
482	064	000	069	Scratch Split
483	064	000	070	Wind Chime
484	064	000	071	Telephone Ring 2
485	064	000	081	Car Engine Ignition
486	064	000	082	Car Tires Squeal
487	064	000	083	Car Passing
488	064	000	084	Car Crash
489	064	000	085	Siren
490	064	000	086	Train
491	064	000	087	Jet Plane
492	064	000	088	Starship
493	064	000	089	Burst
494	064	000	090	Roller Coaster
495	064	000	091	Submarine
496	064	000	097	Laugh
497	064	000	098	Scream
498	064	000	099	Punch
499	064	000	100	Heartbeat
500	064	000	101	Footsteps
501	064	000	113	Machine Gun
502	064	000	114	Laser Gun
503	064	000	115	Explosion
504	064	000	116	Firework

The voice number with an asterisk (\*) is XGlite optional voice.

Voice-Nummern mit einem Stern (\*) sind optionale Xglite-Voices.

Le numéro de voix porteur d'un astérisque (\*) est une voix XGlite en option.

El número de voz con un asterisco (\*) es una voz opcional de XGlite.



# Drum Kit List / Drum Kit-Liste / Liste des kits de

- " " indicates that the drum sound is the same as "Standard Kit 1".
- Each percussion voice uses one note.
- The MIDI Note # and Note are actually one octave lower than keyboard Note # and Note. For example, in "132: Standard Kit 1", the "Seq Click H" (Note# 36/Note C1) corresponds to (Note# 24/Note C0).
- Key Off: Keys marked "O" stop sounding the instant they are released.
- Voices with the same Alternate Note Number ("1 ... 4) cannot be played simultaneously. (They are designed to be played alternately with each other.)

- " " bedeutet, dass der Schlagzeugklang gleich „Standard Kit 1“ ist.
- Jede Perkussionsnote belegt eine Note.
- Die MIDI-Note # und Note sind in Wirklichkeit eine Octave tiefer als hier aufgeführt. Beispiel: In „132: Standard Kit 1“ entspricht die „Seq Click H“ (Note# 36/Note C1) der Note (Note# 24/Note C0).
- Key Off: Mit „O“ bezeichnete Tasten hören sofort auf zu klingen, sobald sie losgelassen werden.
- Stimmen mit derselben Alternate Note Number ("1 ... 4) können nicht gleichzeitig gespielt werden. (Diese Stimmen sind dazu gedacht, wechselweise gespielt zu werden.)

	Voice No.				Key Off	Alternate assign	132	133	134	135	136	137
	MSB (0-127) / LSB (0-127)		/ PC (1-128)				127/000/001	127/000/002	127/000/009	127/000/017	127/000/025	127/000/026
	Keyboard Note#	MIDI Note	Keyboard Note#	MIDI Note			Standard Kit 1	Standard Kit 2	Room Kit	Rock Kit	Electronic Kit	Analog Kit
D0	C#0	25	C#	0	13	C#	-1	3	Surdo Mute			
		26	D	0	14	D	-1	3	Surdo Open			
E0	D#0	27	D#	0	15	D#	-1		Hi Q			
		28	E	0	16	E	-1		Whip Slap			
F0	F#0	29	F#	0	17	F#	-1	4	Scratch H			
		30	F#	0	18	F#	-1	4	Scratch L			
G0	G#0	31	G#	0	19	G#	-1		Finger Snap			
		32	G#	0	20	G#	-1		Click Noise			
A0	A#0	33	A#	0	21	A#	-1		Metronome Click			
		34	A#	0	22	A#	-1		Metronome Bell			
B0		35	B	0	23	B	-1		Seq Click L			
C1		36	C	1	24	C	0		Seq Click H			
		37	C#	1	25	C#	0		Brush Tap			
D1	D#1	38	D#	1	26	D#	0	O	Brush Swirl			
		39	D#	1	27	D#	0		Brush Slap			
E1		40	E	1	28	E	0	O	Brush Tap Swirl			
		41	F	1	29	F	0	O	Snare Roll	Snare Roll 2		
F1	F#1	42	F#	1	30	F#	0		Castanet		Hi Q 2	Hi Q 2
		43	G	1	31	G	0		Snare Soft	Snare Soft 2	Snare Noisy	Snare Snappy Electro
G1	G#1	44	G#	1	32	G#	0		Sticks		Snare Noisy 4	Snare Noisy 4
		45	A	1	33	A	0		Kick Soft		Kick Tight 2	Kick 3
A1	A#1	46	A#	1	34	A#	0		Open Rim Shot	Open Rim Shot H Short	Kick 2	Kick Gate
		47	B	1	35	B	0		Kick Tight	Kick Tight Short	Kick Gate Heavy	Kick Analog Short
B1		48	C	2	36	C	1		Kick	Kick Short		Kick Analog
C2	C#2	49	C#	2	37	C#	1		Side Stick			Side Stick Analog
		50	D	2	38	D	1		Snare	Snare Short	Snare Snappy	Snare Rock
D2	D#2	51	D#	2	39	D#	1		Hand Clap		Snare Rock	Snare Noisy 2
		52	E	2	40	E	1		Snare Tight	Snare Tight H	Snare Rock Rim	Snare Noisy 3
E2	F#2	53	F#	2	41	F#	1		Floor Tom L	Tom Room 1	Tom Rock 1	Tom Electro 1
		54	F#	2	42	F#	1	1	Hi-Hat Closed			Tom Analog 1
F2	G#2	55	G#	2	43	G#	1		Floor Tom H	Tom Room 2	Tom Rock 2	Tom Electro 2
		56	G#	2	44	G#	1	1	Hi-Hat Pedal			Tom Analog 2
G2	A#2	57	A#	2	45	A#	1		Low Tom	Tom Room 3	Tom Rock 3	Tom Electro 3
		58	A#	2	46	A#	1	1	Hi-Hat Open			Tom Analog 3
A2	B#2	59	B#	2	47	B#	1		Mid Tom L	Tom Room 4	Tom Rock 4	Tom Electro 4
		60	C	3	48	C	2		Mid Tom H	Tom Room 5	Tom Rock 5	Tom Electro 5
B2	C#3	61	C#	3	49	C#	2		Crash Cymbal 1			Tom Analog 5
		62	D	3	50	D	2		High Tom	Tom Room 6	Tom Rock 6	Tom Electro 6
C3	D#3	63	D#	3	51	D#	2		Ride Cymbal 1			Tom Analog 6
		64	E	3	52	E	2		Chinese Cymbal			
E3	F#3	65	F#	3	53	F#	2		Ride Cymbal Cup			
		66	F#	3	54	F#	2		Tambourine			
F3	G#3	67	G#	3	55	G#	2		Splash Cymbal			
		68	G#	3	56	G#	2		Cowbell			Cowbell Analog
G3	A#3	69	A#	3	57	A#	2		Crash Cymbal 2			
		70	A#	3	58	A#	2		Vibraslap			
A3	B#3	71	B#	3	59	B#	2		Ride Cymbal 2			
		72	C	4	60	C	3		Bongo H			
B3	C#4	73	C#	4	61	C#	3		Bongo L			
		74	D	4	62	D	3		Conga H Mute			Conga Analog H
D3	D#4	75	D#	4	63	D#	3		Conga H Open			Conga Analog M
		76	E	4	64	E	3		Conga L			Conga Analog L
E3	F#4	77	F#	4	65	F#	3		Timbale H			
		78	F#	4	66	F#	3		Timbale L			
F3	G#4	79	G#	4	67	G#	3		Agogo H			
		80	G#	4	68	G#	3		Agogo L			
G3	A#4	81	A#	4	69	A#	3		Cabasa			
		82	A#	4	70	A#	3		Maracas			Maracas 2
A3	B#4	83	B#	4	71	B#	3	O	Samba Whistle H			
		84	C	5	72	C	4	O	Samba Whistle L			
B3	C#5	85	C#	5	73	C#	4		Güiro Short			
		86	D	5	74	D	4	O	Güiro Long			
D3	D#5	87	D#	5	75	D#	4		Claves			Claves 2
		88	E	5	76	E	4		Wood Block H			
E3	F#5	89	F#	5	77	F#	4		Wood Block L			
		90	F#	5	78	F#	4		Cuica Mute		Scratch H 2	Scratch H 2
F3	G#5	91	G#	5	79	G#	4		Cuica Open		Scratch L 2	Scratch L 3
		92	G#	5	80	G#	4	2	Triangle Mute			
G3	A#5	93	A#	5	81	A#	4	2	Triangle Open			
		94	A#	5	82	A#	4		Shaker			
A3	B#5	95	B#	5	83	B#	4		Jingle Bells			
		96	C	6	84	C	5		Bell Tree			
B3	C#6	97	C#	6	85	C#	5					
		98	D	6	86	D	5					
D3	D#6	99	D#	6	87	D#	5					
		100	E	6	88	E	5					
E3	F#6	101	F#	6	89	F#	5					
		102	F#	6	90	F#	5					
F3	G#6	103	G#	6	91	G#	5					

# percussion / Lista de juegos de batería

- « **■** » indique que les sonorités de percussion sont identiques à celles de « Standard Kit 1 ».
- Chaque voix de percussion utilise une note unique.
- Le numéro de note MIDI (Note #) et la note MIDI se situent en réalité à une octave inférieure à celle qui est indiquée dans la liste. Par exemple, dans « 132 : Standard Kit 1 », « Seq Click H » (Note# 36/Note C1) correspond à (Note# 24/Note C0).
- Key Off : pour les touches signalées par « O », l'émission de sons s'arrête instantanément aussitôt que les touches sont relâchées.
- Les voix portant un même numéro de note alternative (\*1 ... 4) ne peuvent pas être jouées simultanément. (Elles sont en effet conçues pour être interprétées en alternance).

- « **■** » indica que el sonido de batería es el mismo que el "Standard Kit 1".
- Cada sonido de percusión utiliza una nota.
- La nota MIDI # y la nota son en realidad una octava menos de lo que aparece en la lista. Por ejemplo, en "132: Standard Kit 1", el "Seq Click H" (Nota# 36/Nota C1) corresponde a (Nota# 24/Nota C0).
- Tecla desactivada: las teclas marcadas con "O" dejan de sonar en el momento en que se sueltan.
- Los sonidos con el mismo número alterno de nota (\*1 ... 4) no pueden tocarse simultáneamente. (Están diseñados para tocarse alternativamente el uno con el otro.)

	Voice No.				Key Off	Alternate assign	132	138	139	140	141	142	143
	MSB (0-127) / LSB (0-127) / PC (1-128)						127/000/001	127/000/113	127/000/033	127/000/041	127/000/049	126/000/001	126/000/002
	Keyboard Note#	MIDI Note	Keyboard Note#	MIDI Note			Standard Kit 1	Dance Kit	Jazz Kit	Brush Kit	Symphony Kit	SFX Kit 1	SFX Kit 2
D0	C#0	25	C# 0	13	C# -1	3	Surdo Mute						
		26	D# 0	14	D -1	3	Surdo Open						
E0	D#0	27	D# 0	15	D# -1		Hi O						
F0	F#0	28	E 0	16	E -1		Whip Slap						
		29	F 0	17	F -1	4	Scratch H						
G0	F#0	30	F# 0	18	F# -1	4	Scratch L						
		31	G 0	19	G -1		Finger Snap						
A0	G#0	32	G# 0	20	G# -1		Click Noise						
		33	A 0	21	A -1		Metronome Click						
B0	A#0	34	A# 0	22	A# -1		Metronome Bell						
		35	B 0	23	B -1		Seq Click L						
C1	C#1	36	C 1	24	C 0		Seq Click H						
		37	C# 1	25	C# 0		Brush Tap						
D1	D#1	38	D 1	26	D 0	O	Brush Swirl						
		39	D# 1	27	D# 0		Brush Slap						
E1	D#1	40	E 1	28	E 0	O	Brush Tap Swirl	Reverse Cymbal					
F1	F#1	41	F 1	29	F 0	O	Snare Roll						
		42	F# 1	30	F# 0		Castanet	Hi Q 2					
G1	G#1	43	G 1	31	G 0		Snare Soft	Snare Techno	Snare Jazz H	Brush Slap 2			
		44	G# 1	32	G# 0		Sticks						
A1	A#1	45	A 1	33	A 0		Kick Soft	Kick Techno Q			Kick Soft 2		
B1	A#1	46	A# 1	34	A# 0		Open Rim Shot	Rim Gate					
		47	B 1	35	B 0		Kick Tight	Kick Techno L			Gran Cassa		
C2	C#2	48	C 2	36	C 1		Kick	Kick Techno	Kick Jazz	Kick Small	Gran Cassa Mute	Cutting Noise	Phone Call
		49	C# 2	37	C# 1		Side Stick	Side Stick Analog				Cutting Noise 2	Door Squeak
D2	D#2	50	D 2	38	D 1		Snare	Snare Clap	Snare Jazz L	Brush Slap 3	Band Snare		Door Slam
		51	D# 2	39	D# 1		Hand Clap					String Slap	Scratch Cut
E2	D#2	52	E 2	40	E 1		Snare Tight	Snare Dry	Snare Jazz M	Brush Tap 2	Band Snare 2		Scratch H 3
F2	F#2	53	F 2	41	F 1		Floor Tom L	Tom Analog 1	Tom Jazz 1	Tom Brush 1	Tom Jazz 1		Wind Chime
		54	F# 2	42	F# 1	1	Hi-Hat Closed	Hi-Hat Closed Analog3					Telephone Ring 2
G2	G#2	55	G 2	43	G 1		Floor Tom H	Tom Analog 2	Tom Jazz 2	Tom Brush 2	Tom Jazz 2		
		56	G# 2	44	G# 1	1	Hi-Hat Pedal	Hi-Hat Closed Analog 4					
A2	A#2	57	A 2	45	A 1		Low Tom	Tom Analog 3	Tom Jazz 3	Tom Brush 3	Tom Jazz 3		
B2	A#2	58	A# 2	46	A# 1	1	Hi-Hat Open	Hi-Hat Open Analog 2					
		59	B 2	47	B 1		Mid Tom L	Tom Analog 4	Tom Jazz 4	Tom Brush 4	Tom Jazz 4		
C3	C#3	60	C 3	48	C 2		Mid Tom H	Tom Analog 5	Tom Jazz 5	Tom Brush 5	Tom Jazz 5		
		61	C# 3	49	C# 2		Crash Cymbal 1	Tom Analog 6			Hand Cymbal		
D3	D#3	62	D 3	50	D 2		High Tom	Tom Analog 6	Tom Jazz 6	Tom Brush 6	Tom Jazz 6		
		63	D# 3	51	D# 2		Ride Cymbal 1					Hand Cymbal Short	
E3	D#3	64	E 3	52	E 2		Chinese Cymbal						Flute Key Click
F3	F#3	65	F 3	53	F 2		Ride Cymbal Cup						Car Engine Ignition
		66	F# 3	54	F# 2		Tambourine						Car Tires Squeak
G3	G#3	67	G 3	55	G 2		Splash Cymbal						Car Passing
		68	G# 3	56	G# 2		Cowbell	Cowbell Analog					Car Crash
A3	A#3	69	A 3	57	A 2		Crash Cymbal 2						Siren
B3	A#3	70	A# 3	58	A# 2		Vibraslap						Train
		71	B 3	59	B 2		Ride Cymbal 2						Jet Plane
C4	C#4	72	C 4	60	C 3		Bongo H						Starship
		73	C# 4	61	C# 3		Bongo L						Burst
D4	D#4	74	D 4	62	D 3		Conga H Mute	Conga Analog H					Roller Coaster
		75	D# 4	63	D# 3		Conga H Open	Conga Analog M					Submarine
E4	F#4	76	E 4	64	E 3		Conga L	Conga Analog L					
F4	F#4	77	F 4	65	F 3		Timbale H						
		78	F# 4	66	F# 3		Timbale L						
G4	G#4	79	G 4	67	G 3		Agogo H						
		80	G# 4	68	G# 3		Agogo L						
A4	A#4	81	A 4	69	A 3		Cabasa						Shower
		82	A# 4	70	A# 3		Maracas	Maracas 2					Thunder
B4	A#4	83	B 4	71	B 3	O	Samba Whistle H						Wind
		84	C 5	72	C 4	O	Samba Whistle L						Punch
C5	C#5	85	C# 5	73	C# 4		Guiro Short						Stream
		86	D 5	74	D 4	O	Guiro Long						Bubble
D5	D#5	87	D# 5	75	D# 4		Claves	Claves 2					Feed
		88	E 5	76	E 4		Wood Block H						
E5	F#5	89	F 5	77	F 4		Wood Block L						
		90	F# 5	78	F# 4		Cuica Mute	Scratch H 2					
G5	G#5	91	G 5	79	G 4		Cuica Open	Scratch L 3					
		92	G# 5	80	G# 4	2	Triangle Mute						
A5	A#5	93	A 5	81	A 4	2	Triangle Open						
B5	A#5	94	A# 5	82	A# 4		Shaker						
		95	B 5	83	B 4		Jingle Bells						
C6	C#6	96	C 6	84	C 5		Bell Tree						Dog
		97	C# 6	85	C# 5								Horse
D6	D#6	98	D 6	86	D 5								Laser Gun
		99	D# 6	87	D# 5								Bird Tweet 2
E6	F#6	100	E 6	88	E 5								Explosion
		101	F 6	89	F 5								Firework
F6	F#6	102	F# 6	90	F# 5								
G6	F#6	103	G 6	91	G 5								



# Style List / Style-Liste / Liste des styles / Lista de estilos

Style No.	Style Name
<b>8BEAT</b>	
1	ChartPianoPop
2	BritPopRock
3	8BeatModern
4	Cool8Beat
5	Classic8Beat
6	60'sGuitarPop
7	8BeatAdria
8	60's8Beat
9	BubblegumPop
10	BritPopSwing
11	OffBeat
12	60'sRock
13	HardRock
14	RockShuffle
15	8BeatRock
<b>16BEAT</b>	
16	16Beat
17	PianoPopShuffle
18	PopShuffle1
19	PopShuffle2
20	GuitarPop
21	16BeatUptempo
22	KoolShuffle
23	JazzRock
24	HipHopLight
<b>BALLAD</b>	
25	ChartPianoBld
26	PopGtrBallad
27	80'sBallad
28	PianoBallad
29	LoveSong
30	6-8ModernEP
31	6-8SlowRock
32	6-8OrchBallad
33	OrganBallad
34	PopBallad
35	16BeatBallad1
36	16BeatBallad2
<b>DANCE</b>	
37	ClubBeat
38	Electronica
39	FunkyHouse
40	MellowHipHop
41	EuroTrance
42	Ibiza
43	DreamDance
44	TechnoPolis
45	Clubdance
46	ClubLatin
47	Garage
48	UKPop
49	HipHopGroove
50	HipShuffle
51	HipHopPop
<b>DISCO</b>	
52	70'sDisco1
53	70'sDisco2
54	LatinDisco
55	DiscoPhilly

Style No.	Style Name
56	SaturdayNight
57	DiscoChocolate
58	DiscoHands
<b>SWING&amp;JAZZ</b>	
59	TradJazzPiano1
60	TradJazzPiano2
61	PianoBarBlues
62	BigBandFast
63	BigBandMedium
64	BigBandBallad
65	BigBandShuffle
66	JazzClub
67	Swing1
68	Swing2
69	OrchestraSwing
70	Five-Four
71	JazzBallad
72	Dixieland
73	Ragtime
74	AfroCuban
75	Charleston
<b>R&amp;B</b>	
76	Soul
77	DetroitPop1
78	60'sRock&Roll
79	6-8Soul
80	CrocoTwist
81	Rock&Roll
82	DetroitPop2
83	BoogieWoogie
84	ComboBoogie
85	6-8Blues
<b>COUNTRY</b>	
86	70'sCountry
87	Country8Beat
88	CountryPop
89	CountrySwing
90	CountryBallad
91	Country2-4
92	CowboyBoogie
93	CountryShuffle
94	Bluegrass
<b>LATIN</b>	
95	BrazilianSamba
96	BossaNova
97	PopBossa
98	Tijuana
99	DiscoLatin
100	Mambo
101	Salsa
102	Beguine
103	GuitarRumba
104	RumbaFlamenco
105	Rumbalsland
106	Reggae
<b>BALLROOM</b>	
107	VienneseWaltz
108	EnglishWaltz
109	Slowfox
110	Foxtrot

Style No.	Style Name
111	Quickstep
112	Tango
113	Pasodoble
114	Samba
115	ChaChaCha
116	Rumba
117	Jive
<b>TRADITIONAL</b>	
118	USMarch
119	6-8March
120	GermanMarch
121	PolkaPop
122	OberPolka
123	Tarantella
124	Showtune
125	ChristmasSwing
126	ChristmasWaltz
127	ScottishReel
128	Hawaiian
<b>WALTZ</b>	
129	ItalianWaltz
130	MariachiWaltz
131	GuitarSerenade
132	SwingWaltz
133	JazzWaltz1
134	JazzWaltz2
135	CountryWaltz
136	OberWaltzer
137	Musette
<b>CHILDREN</b>	
138	Learning2-4
139	Learning4-4
140	Learning6-8
141	Fun 3-4
142	Fun 4-4
<b>PIANIST</b>	
143	Stride
144	PianoBlues1
145	PianoBlues2
146	PianoRag
147	PianoRock&Roll
148	PianoBoogie
149	PianoJazzWaltz
150	PianoJazzBld
151	Arpeggio
152	Musical
153	Habanera
154	SlowRock
155	8BtPianoBallad
156	PianoMarch
157	6-8PianoMarch
158	PianoWaltz
159	PianoBeguine
160	PianoSwing



# Music Database List / Musikdatenbankliste / Liste des bases de données musicales / Lista de la base de datos musical

MDB No.	MDB Name	MDB No.	MDB Name	MDB No.	MDB Name	MDB No.	MDB Name	MDB No.	MDB Name
<b>ALL TIME HITS</b>		62	WatchGrl	123	Shouting	<b>COUNTRY</b>		243	Donald's
1	Jude Hey	<b>POP BALLAD</b>		124	Rock&Rll	183	OnTheRd	244	MoonWlz
2	New UK	63	WnderLnd	125	HonkyTnk	184	Breathe	245	MoulinHt
3	MyLoving	64	CanIStop	<b>OLDIES</b>		185	InMyMind	246	Sunshine
4	All OK	65	EvryTime	126	Daydream	186	ContryHw	247	PieceOf
5	Buttercp	66	IvoryAnd	127	Sumertme	187	GreenGrs	248	GreenSlv
6	JustCall	67	TheWorld	128	Diana's	188	EverNeed	249	TakeFour
7	CheepChp	68	LovWoman	129	Uptown	189	Lonesome	250	TexRose
8	Daddy's	69	Dolannes	130	Apache	190	Lucille	251	ThePolka
9	Dance?	70	Madigan	131	IGotIt	191	HomeRng	252	Scarboro
10	GetBack	71	Paradise	132	Tonight	192	Tennessee	253	Edelweis
11	GtrWheel	72	Whisper	133	MyPillow	<b>LATIN</b>		254	AroundWd
12	HighTide	<b>BALLAD</b>		134	NoRain	193	Bananabt	255	Whatever
13	IWasBorn	73	AllOdds	135	FinalDance	194	DanceMng	256	Yankee's
14	Sailing	74	AtonalFl	136	SplrLion	195	DntWorry	<b>WORLD</b>	
15	BluJeans	75	Hero	137	Ghetto	196	Jamaica	257	Hawaii
16	Holiday	76	Woman	138	LipsLcky	197	FleaSpa	258	D'amor
17	Imagine	77	RunToYou	139	PrettyWm	198	I'mPola	259	ElCondor
18	LoveMe	78	LoveOfAl	140	TikiGtr	199	MamboJm	260	GoodbyRm
19	LetItBld	79	CndleWnd	141	TurnThre	200	OneNote	261	ILandOn
20	LdyMdona	80	Cavatina	142	Sherry	201	PasoCanI	262	ItalyBel
21	YelowSub	81	Cherish	<b>DANCE &amp; DISCO</b>		202	SayNoMor	263	Cucarumb
22	Marriage	82	ToLoveMe	143	Babylon	203	Beguine	264	Puntuali
23	MovinOut	83	YouKnow	144	Goodbye	204	Tijuna	265	Cielito
24	My Shell	84	Evrythng	145	Catch22	205	Picture	266	ItalySun
25	NowNever	85	EyesOfBl	146	DISCO	<b>ENTERTAINMENT</b>		267	SantaLuc
26	DoLoveMe	86	Hello	147	Survival	206	OnTheHil	268	Trumpetr
27	TcktRide	87	BeThere	148	TheNavy	207	Barnacle	269	VanMass
28	SeeClear	88	FlyAway	149	DontHide	208	Califrag	<b>PIANIST</b>	
29	Masachus	89	LoveYou	150	Celebrat	209	DadClock	270	ItalySun
30	Hard Day	90	NeverLet	151	LondonRU	210	DancelD	271	BeGood
31	USA Pie	91	JustOnce	152	10,2 Sun	211	DnceFire	272	Chaie's
32	Norway	92	IfYouGo	153	ShakeYou	212	BigCntry	273	Flower
33	YesterBd	93	SavingAl	154	Believe	213	Cabaret	274	Frenetic
<b>MODERN POP</b>		94	InTheDrk	155	BoySumer	214	OdeToJoy	275	Highwy66
34	Watches	95	LovePwr	156	I'mSexy	215	Mi-Re-Do	276	Leaves
35	SoundMPH	96	Vision	157	StuffHot	216	MyPrince	277	Miload
36	Hold Us	97	Beautifl	<b>SWING &amp; JAZZ</b>		217	Necessary	278	Cabaret
37	Unfound	98	AllAlone	158	Patrol	218	NoBuiz	279	Wonderfl
38	NeedSome	99	Opposite	159	Charles	219	NoisyOld	280	Submarin
39	PrtTmLvr	100	BeHonest	160	GiveLove	220	Sleigh	281	Mi-Re-Do
40	MoonShdw	101	SayYou	161	Rhythm	221	RockBaby	282	MoreRhum
41	NikitSng	102	SayNthng	162	LOVE	222	Magnifq	283	NoBuiz
42	Sure of	103	Stranger	163	LeroyBad	223	Magnfnt	284	BeatifulSn
43	Off Day	104	OneDay	164	Caraban	224	SilentNt	285	OhBlah
44	Tell Her	105	TheBayou	165	Misbehav	225	Nabucco	286	Charades
45	GirlsMne	106	ThisSong	166	Safari	226	Standing	287	Sally's
46	NeedLove	107	Distance	167	Smiling	227	SummerPl	288	Nabucco
<b>POP CLASSICS</b>		108	ThisWay	168	SoWhatls	228	Christs	289	Spanish
47	Standing	109	LoveGone	169	TimeGone	229	Favorite	290	SunnyStr
48	RainLaff	110	Inspirng	170	TasteHny	230	Tubbie	291	MistyFln
49	Sunshine	111	TrueColr	171	Sandman	231	Turkish	292	LdnBridg
50	ForNamdo	<b>ROCK &amp; ROLL</b>		172	Tunisian	232	12OClock	293	GrndClck
51	ThankFor	112	ShakenUp	173	TwoFoot	<b>WALTZ &amp; TRADITIONAL</b>		294	Importnc
52	ManPiano	113	Beethovn	174	MyBaby	233	Blk&White	295	Snowman
53	CoinLane	114	HurryLov	<b>R&amp;B</b>		234	CanCan	296	Favorite
54	LovesYou	115	BeCruel	175	AsPlayed	235	Charmain	297	SugerSpn
55	Tmbourin	116	Jumping	176	BabyGroV	236	Musibox	298	Washngtn
56	Alone	117	Countdwn	177	Highwy66	237	Clementn	299	ThisWay
57	GldField	118	SuePeggy	178	SweetCHI	238	Doodah!	300	ZipperD
58	Raindrop	119	Champion	179	JustU&Me	239	Dreamer		
59	SultanSw	120	Jailhous	180	ManLoves	240	EnterRag		
60	Life'sWk	121	BlueShoe	181	OurLove	241	BirthDay		
61	TopWorld	122	Rockin24	182	Wish I	242	MaryLamb		



Songs Provided On the Supplied CD-ROM / Songs auf der beiliegenden CD-ROM / Morceaux disponibles sur le CD-ROM fourni / Canciones incluidas en el CD-ROM proporcionado

File Name	Song Name	Composer
001Nutcr.mid	Danse des Mirlitons from "The Nutcracker"	P.I. Tchaikovsky
002Orphe.mid	"Orphée aux Enfers" Ouverture	J. Offenbach
003Slavo.mid	Slavonic Dances op.72-2	A. Dvořák
004Prima.mid	La Primavera (from Le Quattro Stagioni)	A. Vivaldi
005Medit.mid	Méditation (Thaïs)	J. Massenet
006Guill.mid	Guillaume Tell	G. Rossini
007Frühl.mid	Frühlingslied	F. Mendelssohn
008Ungar.mid	Ungarische Tänze Nr.5	J. Brahms
009Frühl.mid	Frühlingsstimmen	J. Strauss II
010Dolly.mid	Dolly's Dreaming and Awakening	T.Oesten
011Cande.mid	La Candeur	J.F.Burgmüller
012Arabe.mid	Arabesque	J.F.Burgmüller
013Pasto.mid	Pastorale	J.F.Burgmüller
014Petit.mid	Petite Réunion	J.F.Burgmüller
015Innoc.mid	Innocence	J.F.Burgmüller
016Progr.mid	Progrès	J.F.Burgmüller
017Taren.mid	Tarentelle	J.F.Burgmüller
018Cheva.mid	La Chevaleresque	J.F.Burgmüller
019Etude.mid	Etude op.10-3 "Chanson de l'adieu"	F.Chopin
020Marci.mid	Marcia alla Turca	L.v. Beethoven
021Turki.mid	Turkish March	W.A. Mozart
022Valse.mid	Valse op.64-1 "Petit Chien"	F.Chopin
023Menue.mid	Menuett	L. Boccherini
024Momen.mid	Moments Musicaux op.94-3	F. Schubert
025Enter.mid	The Entertainer	S. Joplin
026Prelu.mid	Prelude (Wohltemperierte Klavier 1-1)	J.S. Bach
027Violl.mid	La Viollette	L.Streabbog
028Angel.mid	Angels Serenade	Traditional
029Saraf.mid	Krasnyj Sarafan	Traditional
030Ameri.mid	America the Beautiful	S.A. Ward
031Brown.mid	Little Brown Jug	Traditional
032Lomon.mid	Loch Lomond	Traditional
033Bonni.mid	My Bonnie	Traditional
034Londo.mid	Londonderry Air	Traditional
035Banjo.mid	Ring de Banjo	S.C. Foster
036Vogle.mid	Wenn ich ein Vöglein wär ?	Traditional
037Lorel.mid	Die Lorelei	F. Silcher
038Funic.mid	Funiculi Funicula	L. Denza
039Turke.mid	Turkey in the Straw	Traditional
040Campt.mid	Campdown Races	S.C. Foster
041Jingl.mid	Jingle Bells	J.S. Pierpont
042Muss.mid	Muss i denn	F. Silcher
043Liebe.mid	Liebesträume Nr.3	F. Liszt
044Jesu.mid	Jesu, Joy Of Man's Desiring	J.S. Bach
045Joy.mid	Ode to Joy	L.v. Beethoven
046Pearl.mid	Pearl Fisher	G. Bizet
047Gavot.mid	Gavotte	F.J. Gossec
048Seren.mid	Serenade/Haydn	F.J. Haydn
049Menue.mid	Menuett BWV. Anh.114	J.S. Bach
050Canon.mid	Canon in D	J. Pachelbel
051Vogel.mid	Der Vogelfänger Bin Ich Ja "Die Zauberflöte"	W.A. Mozart
052Piano.mid	Piano Sonata No.14 op.27-2 "Mondschein"	L.v. Beethoven
053Surpr.mid	The "Surprise" Symphony No.94	F.J. Haydn
054WildR.mid	To a Wild Rose	E.A. MacDowell
055Chans.mid	Chanson du Toreador	G. Bizet
056Babbi.mid	O Mio Babbino Caro	G. Puccini
057RowRo.mid	Row Row Row Your Boat (DUET)	Traditional
058Smoky.mid	On Top of Old Smoky (DUET)	Traditional
059WeWis.mid	We Wish You A Merry Christmas (DUET)	Traditional
060ImMai.mid	Im Mai (DUET)	Traditional
061Chris.mid	O Christmas Tree (DUET)	Traditional
062MaryH.mid	Mary Had a Little Lamb (DUET)	Traditional
063TenLi.mid	Ten Little Indians (DUET)	S. Winner
064PopGo.mid	Pop Goes The Weasel (DUET)	Traditional
065Twinkl.mid	Twinkle Twinkle Little Star (DUET)	Traditional
066Close.mid	Close Your Hands, Open Your Hands (DUET)	J.J. Rousseau
067Cucko.mid	The Cuckoo (DUET)	Traditional
068Augus.mid	O du lieber Augustin (DUET)	Traditional
069Londo.mid	London Bridge (DUET)	Traditional
070Three.mid	Three Blind Mice (DUET)	Traditional

The easy song arranger can only be used with songs that include chord data.

Easy Song Arranger kann nur zusammen mit Songs verwendet werden, die Akkorddaten enthalten.

La fonction Easy Song Arranger ne s'utilise qu'avec des morceaux comportant des données d'accord.

La función Easy Song Arranger (arreglos sencillos de canciones) sólo puede utilizarse con canciones que incluyan datos de acordes.





# Harmony Type List / Liste der Harmony-Typen / Liste des types d'harmonie / Lista de tipos de armonías

No.	Harmony Type	Description
1	01(Standard Duet)	<p>Harmony types 01–10, 13 are pitch-based and add one-, two- or three-note harmonies to the single-note melody played in the right hand. These types sound when chords are played in the auto accompaniment range of the keyboard. These Harmony types will also work when playing songs that contain chord data.</p> <p>Die Harmony-Typen 01 bis 10, 13 sind Tonhöheneffekte und bereichern eine monophon im rechten Tastaturbereich gespielte Melodie um ein-, zwei- oder dreistimmige Harmonien. Diese Typen werden nur erzeugt, wenn Akkorde im Tastaturbereich für die Begleitung gespielt werden.</p> <p>Les types d'effets Harmony 01–10, 13 sont des effets basés sur la hauteur et ajoutent des harmonies à une, deux ou trois notes à la mélodie à une seule note jouée de la main droite. Ces effets ne sont audibles que lorsque des accords sont joués dans la section d'accompagnement automatique du clavier.</p> <p>Los tipos de armonía 01–10, 13 se basan en el tono y añaden armonías de una, dos o tres notas a la melodía de una sola nota tocada en la parte de la mano derecha. Estos tipos sólo suenan cuando se tocan acordes en la sección del acompañamiento automático del teclado.</p>
2	02(Standard Trio)	
3	03(Full Chord)	
4	04(Rock Duet)	
5	05(Country Duet)	
6	06(Country Trio)	
7	07(Block)	
8	08(4-Way Close 1)	
9	09(4-Way Close 2)	
10	10(4-Way Open)	
11	11(1+5)	
12	12(Octave)	
13	13(Strum)	
14	14(Multi Assign)	
15	15(Echo 1/4)	<p>Types 15–26 are rhythm-based effects and add embellishments or delayed repeats in time with the auto accompaniment. These types sound whether the auto accompaniment is on or not; however, the actual speed of the effect depends on the Tempo setting (page 34). The individual note values in each type let you synchronize the effect precisely to the rhythm. Triplet settings are also available: 1/6 = quarter-note triplets, 1/12 = eighth-note triplets, 1/24 = sixteenth-note triplets.</p> <ul style="list-style-type: none"> <li>• The Echo effect Types (15–18) create delayed repeats of each note played.</li> <li>• The Tremolo effect Types (19–22) repeat all held notes (up to four).</li> <li>• The Trill effect Types (23–26) create two-note trills (alternating notes) when two notes are held.</li> </ul> <p>Die Harmony-Typen 15 bis 26 sind Rhythmus-effekte und erzeugen im Takt zur Begleitautomatik Verzerrungen oder verzögerte Wiederholungen. Der jeweilige Harmony-Effekt wird sowohl bei eingeschalteter als auch bei ausgeschalteter automatischer Bass/Akkord-Begleitung erzeugt; die Effektgeschwindigkeit hängt jedoch stets von der aktuellen Tempoeinstellung ab (Seite 34). Dank der spezifischen Notenwerte der einzelnen Harmony-Typen können Sie den Effekt präzise mit dem Rhythmus synchronisieren. Es gibt auch Triolen-Einstellungen: 1/6 = Viertelnotentriolen, 1/12 = Achtelnotentriolen, 1/24 = Sechzehntelnotentriolen.</p> <ul style="list-style-type: none"> <li>• Die Echo-Effekttypen (15 bis 18) erzeugen verzögerte Wiederholungen jeder gespielten Note.</li> <li>• Mit den Tremolo-Effekttypen (19 bis 22) werden alle gehaltenen Noten (maximal vier Töne) wiederholt.</li> <li>• Die Triller-Effekttypen (23 bis 26) erzeugen Triller (zwei Töne in schnellem Wechsel), wenn zwei Tasten gehalten werden.</li> </ul> <p>Les types 15–26 sont des effets reposant sur le rythme qui ajoutent des embellissements ou des répétitions retardées synchronisées avec l'accompagnement automatique. Ces types d'effets sont audibles que l'accompagnement automatique soit activé ou non. Cependant, la vitesse réelle de l'effet dépend du réglage du tempo (page 34). La valeur individuelle des notes pour chaque type vous permet de synchroniser avec précision l'effet sur le rythme. Des réglages de triole sont également disponibles : 1/6 = triolets de noires, 1/12 = triolets de croches, 1/24 = triolets de doubles croches.</p> <ul style="list-style-type: none"> <li>• Les types d'effets Echo (15–18) créent des répétitions retardées de chaque note jouée.</li> <li>• Les types d'effets Tremolo (19–22) répètent toutes les notes maintenues (jusqu'à quatre notes).</li> <li>• Les types d'effet Trill (23–26) créent des trilles à deux notes (notes alternées) lorsque deux notes sont maintenues enfoncées.</li> </ul> <p>Los tipos 15 a 26 son efectos basados en el ritmo y añaden embellecimientos o repeticiones retardadas en sincronización con el acompañamiento automático. Estos tipos suenan tanto si el acompañamiento automático está activado como si no; sin embargo, la velocidad real del efecto depende del ajuste de tempo (página 34). Los valores de las notas individuales en cada tipo le permiten sincronizar el efecto y el ritmo con una gran precisión. También hay disponibles ajustes de tresillos: 1/6 = tresillos de notas negras, 1/12 = tresillos de corcheas, 1/24 = tresillos de semicorcheas.</p> <ul style="list-style-type: none"> <li>• Los tipos de efectos de eco (15 a 18) crean repeticiones retardadas de cada nota tocada.</li> <li>• Los tipos de efectos de trémolo (19 a 22) repiten todas las notas que se mantienen pulsadas (hasta cuatro).</li> <li>• Los tipos de efectos de trino (23 a 26) crean trinos de dos notas (notas alternadas) cuando se mantienen pulsadas dos teclas.</li> </ul>
16	16(Echo 1/6)	
17	17(Echo 1/8)	
18	18(Echo 1/12)	
19	19(Tremolo 1/8)	
20	20(Tremolo 1/12)	
21	21(Tremolo 1/16)	
22	22(Tremolo 1/32)	
23	23(Trill 1/12)	
24	24(Trill 1/16)	
25	25(Trill 1/24)	
26	26(Trill 1/32)	



# Effect Type List / Effekttyppliste / Liste des types

## ● Reverb Types / Reverb-Typen / Types d'effets Reverb / Tipos de reverberación

No.	Type	Description	MSB	LSB
1	HALL1	Reverb simulating the acoustics of a hall.	1	0
2	HALL2		1	16
3	HALL3		1	17
4	HALL4		1	18
5	HALL5		1	1
6	HALL M		1	6
7	HALL L		1	7
8	BASIC HALL		1	30
9	LARGE HALL		1	31
10	ATMO HALL		1	23
11	ROOM1	Reverb simulating the acoustics of a room.	2	16
12	ROOM2		2	17
13	ROOM3		2	18
14	ROOM4		2	19
15	ROOM5		2	0
16	ROOM6		2	1
17	ROOM7		2	2
18	ROOM S		2	5
19	ROOM M		2	6
20	ROOM L		2	7
21	ACOSTIC ROOM		2	20
22	DRUMS ROOM		2	21
23	PERC ROOM		2	22
24	STAGE1	Reverb suitable for a solo instrument.	3	16
25	STAGE2		3	17
26	STAGE3		3	0
27	STAGE4		3	1
28	PLATE1	Reverb simulating a plate reverb unit.	4	16
29	PLATE2		4	17
30	PLATE3		4	0
31	GM PLATE		4	7
32	TUNNEL	Simulates a cylindrical space expanding to left and right.	17	0
33	CANYON	A hypothetical acoustic space which extends without limit.	18	0
34	BASEMENT	A bit of initial delay followed by reverb with a unique resonance.	19	0
35	WHITE ROOM	A unique short reverb with a bit of initial delay.	16	0
36	NO EFFECT	No effect.	0	0

# d'effets / Lista de tipos de efectos

## ● Chorus Types / Chorus-Typen / Types d'effets Chorus / Tipos de coro

No.	Type	Description	MSB	LSB
1	CHORUS1	Conventional chorus program with rich, warm chorusing.	66	17
2	CHORUS2		66	8
3	CHORUS3		66	16
4	CHORUS4		66	1
5	CHORUS5		65	2
6	CHORUS6		65	0
7	CHORUS7		65	1
8	CHORUS8		65	8
9	CHORUS FAST		65	16
10	CHORUS LITE		65	17
11	GM CHORUS1		65	3
12	GM CHORUS2		65	4
13	GM CHORUS3		65	5
14	GM CHORUS4		65	6
15	FB CHORUS		65	7
16	CELESTE1	A 3-phase LFO adds modulation and spaciousness to the sound.	66	0
17	CELESTE2		66	2
18	SYMPHONIC1	Adds more stages to the modulation of Celeste.	68	16
19	SYMPHONIC2		68	0
20	FLANGER1		67	8
21	FLANGER2	Creates a sound reminiscent of a jet airplane.	67	16
22	FLANGER3		67	17
23	FLANGER4		67	1
24	FLANGER5		67	0
25	GM FLANGER		67	7
26	ROTARY SP1	Simulates a rotary speaker.	69	16
27	ROTARY SP2		71	17
28	ROTARY SP3		71	18
29	ROTARY SP4		70	17
30	ROTARY SP5		66	18
31	ROTARY SP6		69	0
32	ROTARY SP7		71	22
33	2WAY ROT SP		86	0
34	AUTO PAN1	Several panning effects that automatically shift the sound position (left, right, front, back).	71	16
35	AUTO PAN2		71	0
36	EP AUTOPAN		71	21
37	T_AUTO PAN1	Tempo synchronized Auto PAN.	121	0
38	TREMOLO1	Rich Tremolo effect with both volume and pitch modulation.	70	16
39	TREMOLO2		71	19
40	TREMOLO3		70	0
41	EP TREMOLO		70	18
42	GT TREMOLO1		71	20
43	GT TREMOLO2		70	19
44	T_TREMOLO		120	0
45	NO EFFECT		No effect.	0

● DSP Types / DSP Typen / Types de DSP / Tipos de DSP

No.	Type	Description	MSB	LSB
1	HALL1	Reverb simulating the acoustics of a hall.	1	0
2	HALL2		1	16
3	HALL3		1	17
4	HALL4		1	18
5	HALL5		1	1
6	HALL M		1	6
7	HALL L		1	7
8	BASIC HALL		1	30
9	LARGE HALL		1	31
10	ATMO HALL		1	23
11	ROOM1	Reverb simulating the acoustics of a room.	2	16
12	ROOM2		2	17
13	ROOM3		2	18
14	ROOM4		2	19
15	ROOM5		2	0
16	ROOM6		2	1
17	ROOM7		2	2
18	ROOM S		2	5
19	ROOM M		2	6
20	ROOM L		2	7
21	ACOSTIC ROOM		2	20
22	DRUMS ROOM		2	21
23	PERC ROOM		2	22
24	STAGE1	Reverb suitable for a solo instrument.	3	16
25	STAGE2		3	17
26	STAGE3		3	0
27	STAGE4		3	1
28	PLATE1	Reverb simulating a plate reverb unit.	4	16
29	PLATE2		4	17
30	PLATE3		4	0
31	GM PLATE		4	7
32	TUNNEL	Simulates a cylindrical space expanding to left and right.	17	0
33	CANYON	A hypothetical acoustic space which extends without limit.	18	0
34	BASEMENT	A bit of initial delay followed by reverb with a unique resonance.	19	0
35	WHITE ROOM	A unique short reverb with a bit of initial delay.	16	0
36	CHORUS1	Conventional chorus program with rich, warm chorusing.	66	17
37	CHORUS2		66	8
38	CHORUS3		66	16
39	CHORUS4		66	1
40	CHORUS5		65	2
41	CHORUS6		65	0
42	CHORUS7		65	1
43	CHORUS8		65	8
44	CHORUS FAST		65	16
45	CHORUS LITE		65	17
46	GM CHORUS1		65	3
47	GM CHORUS2		65	4
48	GM CHORUS3		65	5
49	GM CHORUS4		65	6
50	FB CHORUS		65	7
51	CELESTE1	A 3-phase LFO adds modulation and spaciousness to the sound.	66	0
52	CELESTE2		66	2
53	SYMPHONIC1	Adds more stages to the modulation of Celeste.	68	16
54	SYMPHONIC2		68	0
55	ENS DETUNE1	Chorus effect without modulation, created by adding a slightly pitch-shifted sound.	87	0
56	ENS DETUNE2		87	16
57	KARAOKE1	Echo for karaoke.	20	0
58	KARAOKE2		20	1
59	KARAOKE3		20	2
60	ER1	This effect isolates only the early reflection components of the reverb.	9	0
61	ER2		9	1
62	GATE REVERB	Simulation of gated reverb.	10	0
63	REVERS GATE	Simulation of gated reverb played back in reverse.	11	0
64	EQ DISCO	Equalizer effect that boosts both high and low frequencies, as is typical in most disco music.	76	16
65	EQ TEL	Equalizer effect that cuts both high and low frequencies, to simulate the sound heard through a telephone receiver.	76	17
66	2BAND EQ	A stereo EQ with adjustable LOW and HIGH. Ideal for drum Parts.	77	0
67	3BAND EQ	A mono EQ with adjustable LOW, MID, and HIGH equalizing.	76	0

**Effect Type List / Effekttypiste / Liste des types d'effets / Lista de tipos de efectos**

No.	Type	Description	MSB	LSB
68	ST 3BAND EQ	Stereo EQ with adjustable LOW, MID and HIGH equalization.	76	18
69	HM ENHANCE1	Adds new harmonics to the input signal to make the sound stand out.	81	16
70	HM ENHANCE2		81	0
71	FLANGER1	Creates a sound reminiscent of a jet airplane.	67	8
72	FLANGER2		67	16
73	FLANGER3		67	17
74	FLANGER4		67	1
75	FLANGER5		67	0
76	GM FLANGER		67	7
77	V_FLANGER	Flanger which simulates vintage tube and fuzz sounds.	104	0
78	TEMPO FLANGER	Tempo synchronized flanger.	107	0
79	DELAY LCR1	Produces three delayed sounds: L, R and C (center).	5	16
80	DELAY LCR2		5	0
81	DELAY LR	Produces two delayed sounds: L and R. Two feedback delays are provided.	6	0
82	ECHO	Two delayed sounds (L and R), and independent feedback delays for L and R.	7	0
83	CROSS DELAY	The feedback of the two delayed sounds is crossed.	8	0
84	TEMPO DELAY	Tempo synchronized delay.	21	0
85	TEMPO ECHO	Tempo synchronized delay.	21	8
86	TEMPO CROSS	Tempo synchronized L&R delay.	22	0
87	V_DST ROCA	Vintage Distortion.	103	18
88	V_DST FUSION		103	19
89	V_DST CRUNC		98	28
90	V_DST VINTAG		98	29
91	V_DST HARD2		98	30
92	V_DST HEAVY		98	31
93	V_DST HARD1		98	0
94	V_DST SOFT		98	2
95	DIST HARD1	Hard-edge distortion.	75	16
96	DIST HARD2		75	22
97	DIST SOFT1	Soft, warm distortion.	75	17
98	DIST SOFT2		75	23
99	DIST HEAVY	Heavy distortion.	73	0
100	OVERDRIVE1	Adds mild distortion to the sound.	74	0
101	OVERDRIVE2		74	9
102	ST DIST	Stereo distortion.	73	8
103	ST OD	Stereo Overdrive.	74	8
104	ST DIST HARD	Hard-edge stereo distortion.	75	18
105	ST DIST SOFT	Soft, warm soft distortion.	75	19
106	AMP SIM1	A simulation of a guitar amp.	75	0
107	AMP SIM2		75	1
108	ST AMP1		75	20
109	ST AMP2		75	21
110	ST AMP3		75	8
111	ST AMP4		75	24
112	ST AMP5		75	25
113	ST AMP6	75	26	
114	DST+DELAY1	Distortion and Delay are connected in series.	95	16
115	DST+DELAY2		95	0
116	OD+DELAY1	Overdrive and Delay are connected in series.	95	17
117	OD+DELAY2		95	1
118	CMP+DST+DLY1	Compressor, Distortion and Delay are connected in series.	96	16
119	CMP+DST+DLY2		96	0
120	CMP+OD+DLY1	Compressor, Overdrive and Delay are connected in series.	96	17
121	CMP+OD+DLY2		96	1
122	V_DST H+DLY	V Distortion and Delay are connected in series.	98	1
123	V_DST S+DLY		98	3
124	DST+TDLY	Distortion and Tempo Delay are connected in series.	100	0
125	OD+TDLY	Overdrive and Tempo Delay are connected in series.	100	1
126	COMP+DIST1	Compressor and Distortion are connected in series.	73	16
127	COMP+DIST2		73	1
128	CMP+DST+TDLY	Compressor, Distortion and Tempo Delay are connected in series.	101	0
129	CMP+OD+TDLY1	Compressor, Overdrive and Tempo Delay are connected in series.	101	1
130	CMP+OD+TDLY2		101	16
131	CMP+OD+TDLY3		101	17
132	CMP+OD+TDLY4		101	18
133	CMP+OD+TDLY5		101	19
134	CMP+OD+TDLY6		101	20

Effect Type List / Effekttypiste / Liste des types d'effets / Lista de tipos de efectos

No.	Type	Description	MSB	LSB
135	V_DST H+TDL1	V Distortion and Tempo Delay are connected in series.	103	0
136	V_DST H+TDL2		103	17
137	V_DST S+TDL1		103	1
138	V_DST S+TDL2		103	16
139	COMP MED	Holds down the output level when a specified input level is exceeded. A sense of attack can also be added to the sound.	83	16
140	COMP HEAVY		83	17
141	COMP MELODY		105	16
142	COMP BASS		105	17
143	MBAND COMP	Multi-band compressor that allows you to adjust the compression effect for individual frequency bands.	105	0
144	COMPRESSOR	Holds down the output level when a specified input level is exceeded. A sense of attack can also be added to the sound.	83	0
145	NOISE GATE	Gates the input when the input signal falls below a specified level.	84	0
146	VCE CANCEL	Attenuates the vocal part of a CD or other source.	85	0
147	AMBIENCE	Blurs the stereo positioning of the sound to add spatial width.	88	0
148	TALKING MOD	Adds a vowel sound to the input signal.	93	0
149	ISOLATOR	Controls the level of a specified frequency band of the input signal.	115	0
150	PHASER1	Cyclically modulates the phase to add modulation to the sound.	72	0
151	PHASER2		72	8
152	PHASER3		72	19
153	T_PHASER1		108	0
154	T_PHASER2		108	16
155	EP PHASER1		72	17
156	EP PHASER2		72	18
157	EP PHASER3		72	16
158	PITCH CHG1	Changes the pitch of the input signal.	80	16
159	PITCH CHG2		80	0
160	PITCH CHG3		80	1
161	DUAL ROT BRT	Rotary speaker simulation with speed switching.	99	16
162	D ROT BRT F		99	30
163	DUAL ROT WRM		99	17
164	D ROT WRM F		99	31
165	DUAL ROT SP1		99	0
166	DUAL ROT SP2		99	1
167	ROTARY SP1		69	16
168	ROTARY SP2		71	17
169	ROT SP2 FAST	71	23	
170	ROTARY SP3	Simulates a rotary speaker.	71	18
171	ROT SP3 FAST		71	24
172	ROTARY SP4		70	17
173	ROT SP4 FAST		70	20
174	ROTARY SP5		66	18
175	ROT SP5 FAST		66	19
176	ROTARY SP6		69	0
177	ROTARY SP7		71	22
178	ROT SP7 FAST		71	25
179	ROTARY SP8		69	17
180	ROT SP8 FAST		69	18
181	ROTARY SP9	69	19	
182	ROT SP9 FAST	69	20	
183	2WAY ROT SP	86	0	
184	DST+ROT SP	Distortion and rotary speaker connected in series.	69	1
185	DST+2ROT SP	Distortion and 2-way rotary speaker connected in series.	86	1
186	OD+ROT SP	Overdrive and rotary speaker connected in series.	69	2
187	OD+2ROT SP	Overdrive and 2-way rotary speaker connected in series.	86	2
188	AMP+ROT SP	Amp simulator and rotary speaker connected in series.	69	3
189	AMP+2ROT SP	Amp simulator and 2-way rotary speaker connected in series.	86	3
190	AUTO PAN1	Several panning effects that automatically shift the sound position (left, right, front, back).	71	16
191	AUTO PAN2		71	0
192	AUTO PAN3		71	1
193	EP AUTOPAN		71	21
194	T_AUTO PAN1	Tempo synchronized pan.	121	0
195	T_AUTO PAN2		121	1
196	TREMOLO1	Rich Tremolo effect with both volume and pitch modulation.	70	16
197	TREMOLO2		71	19
198	TREMOLO3		70	0
199	EP TREMOLO		70	18
200	GT TREMOLO1		71	20
201	GT TREMOLO2		70	19
202	VIBE VIBRATE	Vibraphone effect.	119	0

Effect Type List / Effekttypiste / Liste des types d'effets / Lista de tipos de efectos

No.	Type	Description	MSB	LSB
203	T_TREMOLO	Tempo synchronized tremolo.	120	0
204	AUTO WAH1	Cyclically modulates the center frequency of a wah filter.	78	16
205	AUTO WAH2		78	0
206	AT WAH+DST1	The output of an Auto Wah can be distorted by Distortion.	78	17
207	AT WAH+DST2		78	1
208	AT WAH+OD1	The output of an Auto Wah can be distorted by Overdrive.	78	18
209	AT WAH+OD2		78	2
210	TEMPO AT WAH	Tempo synchronized auto wah.	79	0
211	TOUCH WAH1	Changes the center frequency of a wah filter according to the input level.	82	0
212	TOUCH WAH2		82	8
213	TOUCH WAH3		82	20
214	TC WAH+DST1		82	16
215	TC WAH+DST2	The output of an Touch Wah can be distorted by Distortion.	82	1
216	TC WAH+OD1	The output of an Touch Wah can be distorted by Overdrive.	82	17
217	TC WAH+OD2		82	2
218	WH+DST+DLY1	Wah, Distortion and Delay are connected in series.	97	16
219	WH+DST+DLY2		97	0
220	WH+DST+TDLY	WAH, Distortion and Tempo Delay are connected in series.	102	0
221	WH+OD+DLY1	Wah, Overdrive and Delay are connected in series.	97	17
222	WH+OD+DLY2		97	1
223	WH+OD+TDLY1	WAH, Overdrive and Tempo Delay are connected in series.	102	1
224	WH+OD+TDLY2		102	16
225	CLVI TC WAH1	Clavinet Touch Wah.	82	18
226	CLVI TC WAH2		82	28
227	EP TC WAH1	EP Touch Wah.	82	19
228	EP TC WAH2		82	29
229	PEDAL WAH	Pedal position changes the center frequency of the wah filter.	122	0
230	PEDAL WH+DST	Distortion applied to the pedal wah output.	122	1
231	P.WH+DIST HD		122	21
232	P.WH+DIST HV		122	23
233	P.WH+DIST LT		122	25
234	PEDAL WH+OD	Overdrive (distortion) applied to the pedal wah output.	122	2
235	P.WH+OD HD		122	22
236	P.WH+OD HV		122	24
237	P.WH+OD LT		122	26
238	NO EFFECT	No effect.	0	0
239	THRU	Bypass without applying an effect.	64	0



# Specifications / Technische Daten / Spécifications techniques / Especificaciones

Dimensions	[W x D x H]	1,369mm x 502mm x 852mm (53-7/8" x 19-3/4" x 33-9/16")
	With music rest [W x D x H]	1,369mm x 502mm x 1,006mm (53-7/8" x 19-3/4" x 39-5/8")
Weight		49kg (108 lbs.)
Keyboard	Type	GHS (Graded Hammer Standard) keyboard with matte black keytops
	Number of keys	88
	Touch Sensitivity	Soft/Medium/Hard/Off
Pedal		Damper (with half-pedal effect), Sostenuto, Soft
Display	Size and Type	320 x 240 dots LCD display (backlit)
	Score, Lyrics	Yes
	Contrast	Yes
Cabinet	Key Cover Style	Sliding
	Music rest	Yes
Voices	Tone Generation Technology	AWM Dynamic Stereo Sampling
	Number of Dynamic Steps	3
	Number of Polyphony (Max.)	64
	Number of Voices	131 panel voices + 12 drum/SFX kits + 361 XGlite voices
Effects	Reverb	35 types
	Chorus	44 types
	Harmony	26 types
	DSP	238 types
	Dual	Yes
	Split	Yes
Styles	Number of Styles	160 Preset styles + External files
	Fingering	Multi fingering/Full keyboard
	One Touch Setting	Yes
Songs	Number of Songs	30 Preset songs + 5 User songs + 70 External songs (CD-ROM)
	Recording	5 User Songs
	Easy Song Arranger	Yes
	Lesson	Yes
Music Data Base	Number of MDB	300 Preset MDB + External files
Storage	USB device	Yes
Tempo	Range	5–280
	Metronome	Yes
Registration Memory		8 Banks x 2
Other Functions	Piano Reset	Yes
	Performance Assistant Technology	Yes
	Transpose, Tuning	Yes
Connectivity	Headphones	2
	USB TO HOST	Yes
	USB TO DEVICE	Yes
Amplifiers/Speakers	Amplifiers	20W + 20W
	Speakers	12cm x 2
Accessories	Included Accessories	Accessories CD-ROM for Windows Installation Guide, My Yamaha Product User Registration, Bench (included or optional depending on locale), Owner's Manual
Optional Accessories	Headphones	HPE-150
	Floppy Disk Drive	UD-FD01

- \* Specifications and descriptions in this owner's manual are for information purposes only. Yamaha Corp. reserves the right to change or modify products or specifications at any time without prior notice. Since specifications, equipment or options may not be the same in every locale, please check with your Yamaha dealer.
- \* Die technischen Daten und Beschreibungen in dieser Bedienungsanleitung dienen nur der Information. Yamaha Corp. behält sich das Recht vor, Produkte oder deren technische Daten jederzeit ohne vorherige Ankündigung zu verändern oder zu modifizieren. Da die technischen Daten, das Gerät selbst oder Sonderzubehör nicht in jedem Land gleich sind, setzen Sie sich im Zweifel bitte mit Ihrem Yamaha-Händler in Verbindung.
- \* Les caractéristiques techniques et les descriptions du mode d'emploi ne sont données que pour information. Yamaha Corp. se réserve le droit de changer ou modifier les produits et leurs caractéristiques techniques à tout moment sans aucun avis. Du fait que les caractéristiques techniques, les équipements et les options peuvent différer d'un pays à l'autre, adressez-vous au distributeur Yamaha le plus proche.
- \* Las especificaciones y descripciones de este manual del propietario tienen sólo el propósito de servir como información. Yamaha Corp. se reserva el derecho a efectuar cambios o modificaciones en los productos o especificaciones en cualquier momento sin previo aviso. Puesto que las especificaciones, equipos u opciones pueden no ser las mismas en todos los mercados, solicite información a su distribuidor Yamaha.



# Important Notice: Guarantee Information for customers in European Economic Area (EEA) and Switzerland

<b>Important Notice: Guarantee Information for customers in EEA* and Switzerland</b> For detailed guarantee information about this Yamaha product, and Pan-EEA* and Switzerland warranty service, please either visit the website address below (Printable file is available at our website) or contact the Yamaha representative office for your country (see overview). * EEA: European Economic Area	<b>English</b>
<b>Wichtiger Hinweis: Garantie-Information für Kunden in der EWR und der Schweiz</b> Für nähere Garantie-Information über dieses Produkt von Yamaha, sowie über den Pan-EWR- und Schweizer Garantieservice, besuchen Sie bitte entweder die folgend angegebene Internetadresse (eine druckfähige Version befindet sich auch auf unserer Webseite), oder wenden Sie sich an den für Ihr Land zuständigen Yamaha-Vertrieb (siehe Rückseite).	<b>Deutsch</b>
<b>Remarque importante: informations détaillées sur la garantie de l'EEE et la Suisse</b> Pour des informations plus détaillées sur la garantie de ce produit Yamaha et sur le service de garantie applicable dans l'ensemble de l'EEE ainsi qu'en Suisse, consultez notre site Web à l'adresse ci-dessous (le fichier imprimable est disponible sur notre site Web) ou contactez directement Yamaha dans votre pays de résidence (voir verso). * EEE : Espace Economique Européen	<b>Français</b>
<b>Belangrijke mededeling: Garantie-informatie voor klanten in de EER* en Zwitserland</b> Voor gedetailleerde garantie-informatie over dit Yamaha-product en de garantieservice in heel de EER* en Zwitserland, gaat u naar de onderstaande website (u vind een afdrukbaar bestand op onze website) of neemt u contact op met de vertegenwoordiging van Yamaha in uw land (zie ommezijde). * EER: Europese Economische Ruimte	<b>Nederlands</b>
<b>Aviso importante: información sobre la garantía para los clientes del EEE* y Suiza</b> Para una información detallada sobre este producto Yamaha y sobre el soporte de garantía en la zona EEE* y Suiza, visite la dirección web que se incluye más abajo (la versión del archivo para imprimir está disponible en nuestro sitio web) o póngase en contacto con el representante de Yamaha en su país (ver al dorso). * EEE: Espacio Económico Europeo	<b>Español</b>
<b>Aviso importante: informazioni sulla garanzia per i clienti residenti nell'EEA* e in Svizzera</b> Per informazioni dettagliate sulla garanzia relativa a questo prodotto Yamaha e l'assistenza in garanzia nei paesi EEA* e in Svizzera, potete consultare il sito Web all'indirizzo riportato di seguito (è disponibile il file in formato stampabile) oppure contattare l'ufficio di rappresentanza locale della Yamaha (indirizzo sul retro). * EEA: Area Economica Europea	<b>Italiano</b>
<b>Aviso importante: informações sobre as garantias para clientes da AEE* e da Suíça</b> Para obter uma informação pormenorizada sobre este produto da Yamaha e sobre o serviço de garantia na AEE* e na Suíça, visite o site a seguir (o arquivo para impressão está disponível no nosso site) ou entre em contato com o escritório de representação da Yamaha no seu país (consulte o verso). * AEE: Área Económica Europeia	<b>Português</b>
<b>Σημαντική σημείωση: Πληροφορίες εγγύησης για τους πελάτες στον ΕΟΧ* και Ελβετία</b> Για λεπτομερείς πληροφορίες εγγύησης σχετικά με το προϊόν προϊόν της Yamaha και την κάλυψη εγγύησης σε όλες τις χώρες του ΕΟΧ και την Ελβετία, επισκεφτείτε την παρακάτω ιστοσελίδα (Εκτυπωτικό αρχείο είναι διαθέσιμο στην οπισθοκλίση μερσί) ή απευθυνθείτε στην αντιπροσωπεία της Yamaha στη χώρα σας (βλ. πίσω μέρος οζονόλης). * ΕΟΧ: Ευρωπαϊκός Οικονομικός Χώρος	<b>Ελληνικά</b>
<b>Viktigt: Garantiformasjon for kunder i EES-området* och Schweiz</b> For detaljert informasjon om denne Yamaha-produktet samt garantisevne og service i hele EES-området* og Sveits kan fås enten ved å besøke nedanstående webbadress (en utskriftsværdig fil finns på webbsajten) eller kontakta Yamahas offisiella representant i ditt land (se baksidan). * EES: Europeiska Ekonomiska Samarbeidsområdet	<b>Svenska</b>
<b>Viktig merknad: Garantiformasjon for kunder i EØS* og Sveits</b> Detaljert garantiformasjon om dette Yamaha-produktet og garantisevne og service for hele EØS-området* og Sveits kan fås enten ved å besøke nettsidene nedenfor (utskriftsversjon finnes på våre nettsider) eller kontakte kontakta Yamaha-kontoret i landet der du bor (se neste side). * EØS: Det europeiske økonomiske samarbeidsområdet	<b>Norsk</b>
<b>Vigtig oplysning: Garantiplysninger til kunder i EØO* og Schweiz</b> De kan finde detaljerede garantiplysninger om dette Yamaha-produkt og den fælles garantisevne og service for hele EØO* og Schweiz ved at besøge det websted, der er angivet nedenfor (der findes en fil, som kan udskrives, på vores websted), eller ved at kontakte Yamahas nationale repræsentationskontor i det land, hvor De bor (se næste side). * EØO: Det Europæiske Økonomiske Område	<b>Dansk</b>

<b>Tärkeä ilmoitus: Takuu tiedot Euroopan talousalueen (ETA)* ja Sveitsin asiakkaille</b> Tämän Yamaha-tuotteen sekä ETA-alueen ja Sveitsin takuuta koskevat yksityiskohtaiset tiedot saatte alla olevasta nettositeltestä. (Tulostettava tiedosto saatavissa sivustollamme.) Voitte myös ottaa yhteyttä paikalliseen Yamahaa edustajaan (lisätietoja käännösolealla). *ETA: Euroopan talousalue	<b>Suomi</b>
<b>Ważne: Warunki gwarancji obowiązujące w EOG* i Szwajcarii</b> Aby dowiedzieć się więcej na temat warunków gwarancyjnych tego produktu, fi my Yamaha i serwisu gwarancyjnego w całym EOG* i Szwajcarii, należy odwiedzić wskazany poniżej stronę internetową (Plik gotowy do wydruku znajduje się na naszej stronie internetowej) lub skontaktować się z przedstawicielem firmy Yamaha w swoim kraju (informacje na ten temat znajdują się na odwrocie strony). * EOG — Europejski Obszar Gospodarczy	<b>Polski</b>
<b>Důležité oznámení: Zásadní informace pro zákazníky v EHS* a ve Švýcarsku</b> Podrobné zásadní informace o tomto produktu Yamaha a záručním servisu v celém EHS* a ve Švýcarsku naleznete na níže uvedené webové adrese (soubor k tisku je dostupný na našich webových stránkách) nebo se můžete obrátit na zástupce firmy Yamaha ve své zemi (viz druhá strana). * EHS: Evropský hospodářský prostor	<b>Česky</b>
<b>Fontos figyelemztes: Garancia-információk az EGT* területén és Svájcban élő vásárlók számára</b> A jelen Yamaha termékre vonatkozó részletes garancia-információk, valamint az EGT*-re és Svájcra kiterjedő garanciális szolgáltatás tekintetében keressék fel webhelyünket az alábbi címen (a webhelyen nyomtatható fájl is talál), vagy pedig lépjen kapcsolatba az országában működő Yamaha képviselői roddával (lásd a következő oldalon). * EGT: Európai Gazdasági Térség	<b>Magyar</b>
<b>Ouline märkus: Garantiteave Euroopa Majanduspiirkonna (EMP)* ja Šveitsi klientidele</b> Täpsemat teabe saamiseks selle Yamaha toote garantii ning kogu Euroopa Majanduspiirkonna ja Šveitsi garantiteeninduse kohta, külastage palun veebisaiti alljärgneval aadressil (meie saidil on saadaval printitav fail) või pöörduge Teie regiooni Yamaha esinduse poole (vt järgmisele leheküljele). * EMP: Euroopa Majanduspiirkond	<b>Eesti keel</b>
<b>Svarīgs paziņojums: garantijas informācija klientiem EEZ* un Šveicē</b> Lai saņemtu detaļāku garantijas informāciju par šo Yamaha produktu, ka arī garantijas apkalpošanu EEZ* un Šveicē, lūdzam apmeklējot zemāk norādīto tīmekļa vietnes adresi (tīmekļa vietnē ir pieejams drukājams fails) vai sazināties ar Jūsu valsti apkalpojošo Yamaha pārstāvniecību (skatiet nākamā lappusi). * EEZ: Eiropas Ekonomikas zona	<b>Latviešu</b>
<b>Dēmos: informācija dēl garantijas priekšams EEE* a Šveicarijā</b> Jei rētikā izzāmis informācijas apie šī „Yamaha” produktu ir jo tehninē priēzrā visojē EEE* a Šveicarijā, aplūmēnkytē mūsē svētinājē lōtāru nurodytu adresē (svētinājē yra spausdināmas failas) arba kreipties 1 „Yamaha” atstovybē savo šaliat (žr. kitojē puslė). *EEE – Europos ekonominė erdvė	<b>Lietuvių kalba</b>
<b>Dôležitē upozornenie: Informácie o záruke pre zákazníkov v EHP* a Švajčiarsku</b> Podrobné informácie o záruke týkajúce sa tohto produktu na Yamaha a garancijnom servise v EHP* a Švajčiarsku nájdete na webovej stránke uvedenej nižšie (ita nálezte webovej stránke je k dispozícii súbór na tlač) alebo sa obráťte na zástupcu spoločnosti Yamaha vo svojej krajine (pozrite nasledujúcu stranu). * EHP: Európsky hospodársky priestor	<b>Slovenčina</b>
<b>Pomembno obvestilo: Informacije o garanciji za kupce v EGP* in Švici</b> Za podrobne informacije o tem Yamahinem izdelku ter garancijskem servisu v celotnem EGP in Švici, obiščite spletno mesto, ki je navedeno spodaj (natisljiva datoteka je na voljo na našem spletnem mestu), ali se obrnite na Yamahinega predstavnika v svoji državi (glejte drugo stran lista). * EGP: Evropski gospodarski prostor	<b>Slovenščina</b>
<b>Важно съобщение: Информация за гаранцията за клиенти в ЕИПТ и Швейцария</b> За подробна информация за гаранцията за този продукт на Yamaha и гаранционното обслужване в маневропийската зона на ЕИПТ и Швейцария или посетете посочения по-долу уеб сайт (на нашия уеб сайт има файл за печат), или се свържете с представителния офис на Yamaha във вашата страна (вж. на гърба). * ЕИПТ: Европейско икономическо пространство	<b>Български език</b>
<b>Notificare importantă: Informații despre garanție pentru clienții din SEE* și Elveția</b> Pentru informații detaliate privind acest produs Yamaha și serviciul de garanție Pan-SEE* și Elveția, vizitați site-ul la adresa de mai jos (fișierul imprimabil este disponibil pe site-ul nostru) sau contactați biroul reprezentanței Yamaha din țara dumneavoastră (a se vedea pe verso). * SEE: Spațiul Economic European	<b>Limba română</b>

<http://europe.yamaha.com/warranty/>

## AUSTRIA

Yamaha Music Europe GmbH  
Branch Austria  
Schleiergasse 20, A-1100 Wien Austria  
Tel: +43 (0)1 602 03900  
Fax: +43 (0)1 602 039051

## BELGIUM

Yamaha Music Europe  
Branch Benelux  
Clarisshof 5b NL, 4133 AB, Vianen  
The Netherlands  
Tel: +31 (0)347 358040  
Fax: +31 (0)347 358060

## BULGARIA

Yamaha Music Europe GmbH  
Branch Austria (Central and Eastern Europe)  
Schleiergasse 20, A-1100 Wien Austria  
Tel: +43 (0)1 602 03900  
Fax: +43 (0)1 602 039051

## CYPRUS

NAKAS Music Cyprus Ltd  
31C Nikis Ave., 1086 Nicosia  
Tel: +357 (0)22 510 477  
Fax: +357 (0)22 511 080

## CZECH REPUBLIC

Yamaha Music Europe GmbH  
Branch Austria (Central and Eastern Europe)  
Schleiergasse 20, A-1100 Wien Austria  
Tel: +43 (0)1 602 03900  
Fax: +43 (0)1 602 039051

## DENMARK

YS Copenhagen Liaison Office  
(Yamaha Scandinavia AB Filial Denmark)  
Generatorvej 6A, 2730 Herlev, Denmark  
Tel: +45 44 92 49 00  
Fax: +45 44 54 47 09

## ESTONIA

Yamaha Music Europe GmbH  
Sp. z o.o. Oddział w Polsce  
(Branch Poland)  
ul. 17 Sycznia 56  
PL-02-146 Warszawa Poland  
Tel: +48 (0)22 500 29 25  
Fax: +48 (0)22 500 29 30

## FINLAND

(For Musical Instrument)  
F - Musiikki OY  
Kaisaniemenkatu 7, PL260  
00101 Helsinki, Finland  
Tel: +358 (0)9 618511  
Fax: +358 (0)9 61851385

## (For Pro Audio)

Yamaha Scandinavia AB  
Yamaha Scandinavia AB  
J.A. Wettergrens gata 1  
Västra Frölunda, Sweden  
(Box 300 53, 400 43 Göteborg  
Sweden - Postal Address)  
Tel: +46 (0)31 893400  
Fax: +46 (0)31 454026

## FRANCE

Yamaha Musique France  
Zone d'activité de Pariest  
7, rue Ambroise Croizat  
77183 Croissy-Beaubourg, France  
(B.P. 70, 77312 Marne la Vallée Cedex 2  
France-Adresse postale)  
Tel: +33 (0)1 64 61 4000  
Fax: +33 (0)1 64 61 4079

## GERMANY

Yamaha Music Europe GmbH  
Siemensstr 22-34  
D-25462 Rellingen, b. Hamburg, Germany  
Tel: +49 (0)4101 3030  
Fax: +49 (0)4101 303 77702

## GREECE

PH: Nakas S.A. Music House/Service  
19 KM Leoforos Lavriou  
19002 Peania / Attiki, Greece  
Tel: +30 (0)210 6686260  
Fax: +30 (0)210 6686269

## HUNGARY

Yamaha Music Europe GmbH  
Branch Austria (Central and Eastern Europe)  
Schleiergasse 20, A-1100 Wien Austria  
Tel: +43 (0)1 602 03900  
Fax: +43 (0)1 602 039051

## ICELAND

(For Musical Instrument)  
HLJODFAERAHJUSID EHF  
Sidumula 20  
108 Reykjavik, Iceland  
Tel: +354 525 50 50  
Fax: +354 568 65 14

## (For Pro Audio)

Yamaha Scandinavia AB  
Yamaha Scandinavia AB  
J.A. Wettergrens gata 1  
Västra Frölunda, Sweden  
(Box 300 53, 400 43 Göteborg  
Sweden - Postal Address)  
Tel: +46 (0)31 893400  
Fax: +46 (0)31 454026

## IRELAND (REPUBLIC OF IRELAND)

Yamaha Music UK Ltd.  
Sherbourne Drive  
Tilbrook, Milton Keynes MK7 8BL  
United Kingdom  
Tel: +353 (0) 1526 2449  
Fax: +44 (0) 1908 369278

## ITALY

Yamaha Musica Italia s.p.a.  
Viale Italia 88  
20020, Lainate (Milano), Italy  
Tel: +39 (0)02 93577 1  
Fax: +39 (0)02 937 0956

## LATVIA

Yamaha Music Europe GmbH  
Sp. z o.o. Oddział w Polsce  
(Branch Poland)  
ul. 17 Sycznia 56  
PL-02-146 Warszawa Poland  
Tel: +48 (0)22 500 29 25  
Fax: +48 (0)22 500 29 30

## LIECHTENSTEIN

Yamaha Music Europe GmbH, Rellingen,  
Branch Switzerland in Zurich  
Seefeldstrasse 94, CH-8008  
Zürich, Switzerland  
Tel: +41 (0)1 3833990  
Fax: +41 (0)1 3833918

## LITHUANIA

Yamaha Music Europe GmbH  
Sp. z o.o. Oddział w Polsce  
(Branch Poland)  
ul. 17 Sycznia 56  
PL-02-146 Warszawa Poland  
Tel: +48 (0)22 500 29 25  
Fax: +48 (0)22 500 29 30

## LUXEMBOURG

Yamaha Music Europe  
Branch Benelux  
Clarisshof 5b NL, 4133 AB, Vianen  
The Netherlands  
Tel: +31 (0)347 358040  
Fax: +31 (0)347 358060

## MALTA

Olimpus Music Ltd.  
The Emporium, Level 3, St. Louis Street  
Misid MSD06  
Tel: +356 (0)2133 2093  
Fax: +356 (0)2133 2144

## NETHERLANDS

Yamaha Music Europe  
Branch Benelux  
Clarisshof 5b NL, 4133 AB, Vianen  
The Netherlands  
Tel: +31 (0)347 358040  
Fax: +31 (0)347 358060

## NORWAY

YS Oslo Liaison Office  
(Yamaha Scandinavia AB Filial Norway)  
Grini Naeringspark 1  
1361 Osteras, Norway  
Tel: +47 67 16 77 70  
Fax: +47 67 16 77 79

## POLAND

YAMAHA Music Europe GmbH  
Sp. z o.o. Oddział w Polsce  
ul. 17 Sycznia 56  
02-146 WARSZAWA/POLSKA  
Tel: +48 (0)22 500 29 25  
Fax: +48 (0)22 500 29 30

## PORTUGAL

Yamaha Musica Ibérica, S.A.U.  
Sucursal Portuguesa  
Rua Alfredo da Silva  
2610-016 Amadora, Portugal  
Tel: +351 214 704 330  
Fax: +351 214 718 220

## ROMANIA

Yamaha Music Europe GmbH  
Branch Austria (Central and Eastern Europe)  
Schleiergasse 20, A-1100 Wien Austria  
Tel: +43 (0)1 602 03900  
Fax: +43 (0)1 602 039051

## SLOVAKIA

Yamaha Music Europe GmbH  
Branch Austria (Central and Eastern Europe)  
Schleiergasse 20, A-1100 Wien Austria  
Tel: +43 (0)1 602 03900  
Fax: +43 (0)1 602 039051

## SLOVENIA

Yamaha Music Europe GmbH  
Branch Austria (Central and Eastern Europe)  
Schleiergasse 20, A-1100 Wien Austria  
Tel: +43 (0)1 602 03900  
Fax: +43 (0)1 602 039051

## SPAIN

Yamaha Musica Ibérica, S.A.U.  
Ctra. de la Coruna km.17, 200  
28230 Las Rozas de Madrid, Spain  
Tel: +34 902 39 8888  
Fax: +34 91 638 4680

## SWEDEN

Yamaha Scandinavia AB  
J.A. Wettergrens gata 1  
Västra Frölunda, Sweden  
(Box 300 53, 400 43 Göteborg  
Sweden - Postal Address)  
Tel: +46 (0)31 893400  
Fax: +46 (0)31 454026

## SWITZERLAND

Yamaha Music Europe GmbH, Rellingen,  
Branch Switzerland in Zurich  
Seefeldstrasse 94, CH-8008  
Zürich, Switzerland  
Tel: +41 (0)1 3833990  
Fax: +41 (0)1 3833918

## UNITED KINGDOM

Yamaha Music UK Ltd.  
Sherbourne Drive  
Tilbrook, Milton Keynes MK7 8BL  
United Kingdom  
Tel: +44 (0) 870 4445575  
Fax: +44 (0) 1908 369278



## Information for Users on Collection and Disposal of Old Equipment



This symbol on the products, packaging, and/or accompanying documents means that used electrical and electronic products should not be mixed with general household waste.

For proper treatment, recovery and recycling of old products, please take them to applicable collection points, in accordance with your national legislation and the Directives 2002/96/EC.

By disposing of these products correctly, you will help to save valuable resources and prevent any potential negative effects on human health and the environment which could otherwise arise from inappropriate waste handling.

For more information about collection and recycling of old products, please contact your local municipality, your waste disposal service or the point of sale where you purchased the items.

### **[For business users in the European Union]**

If you wish to discard electrical and electronic equipment, please contact your dealer or supplier for further information.

### **[Information on Disposal in other Countries outside the European Union]**

This symbol is only valid in the European Union. If you wish to discard these items, please contact your local authorities or dealer and ask for the correct method of disposal.

## Verbraucherinformation zur Sammlung und Entsorgung alter Elektrogeräte



Beindet sich dieses Symbol auf den Produkten, der Verpackung und/oder beiliegenden Unterlagen, so sollten benutzte elektrische Geräte nicht mit dem normalen Haushaltsabfall entsorgt werden.

In Übereinstimmung mit Ihren nationalen Bestimmungen und den Richtlinien 2002/96/EC, bringen Sie alte Geräte bitte zur fachgerechten Entsorgung, Wiederaufbereitung und Wiederverwendung zu den entsprechenden Sammelstellen.

Durch die fachgerechte Entsorgung der Elektrogeräte helfen Sie, wertvolle Ressourcen zu schützen und verhindern mögliche negative Auswirkungen auf die menschliche Gesundheit und die Umwelt, die andernfalls durch unsachgerechte Müllentsorgung auftreten könnten.

Für weitere Informationen zum Sammeln und Wiederaufbereiten alter Elektrogeräte, kontaktieren Sie bitte Ihre örtliche Stadt- oder Gemeindeverwaltung, Ihren Abfallentsorgungsdienst oder die Verkaufsstelle der Artikel.

### **[Information für geschäftliche Anwender in der Europäischen Union]**

Wenn Sie Elektrogeräte ausrangieren möchten, kontaktieren Sie bitte Ihren Händler oder Zulieferer für weitere Informationen.

### **[Entsorgungsinformation für Länder außerhalb der Europäischen Union]**

Dieses Symbol gilt nur innerhalb der Europäischen Union. Wenn Sie solche Artikel ausrangieren möchten, kontaktieren Sie bitte Ihre örtlichen Behörden oder Ihren Händler und fragen Sie nach der sachgerechten Entsorgungsmethode.

## Information concernant la Collecte et le Traitement des déchets d'équipements électriques et électroniques.

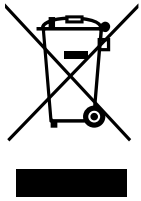

Le symbole sur les produits, l'emballage et/ou les documents joints signifie que les produits électriques ou électroniques usagés ne doivent pas être mélangés avec les déchets domestiques habituels.

Pour un traitement, une récupération et un recyclage appropriés des déchets d'équipements électriques et électroniques, veuillez les déposer aux points de collecte prévus à cet effet, conformément à la réglementation nationale et aux Directives 2002/96/EC.

En vous débarrassant correctement des déchets d'équipements électriques et électroniques, vous contribuerez à la sauvegarde de précieuses ressources et à la prévention de potentiels effets négatifs sur la santé humaine qui pourraient advenir lors d'un traitement inapproprié des déchets.

Pour plus d'informations à propos de la collecte et du recyclage des déchets d'équipements électriques et électroniques, veuillez contacter votre municipalité, votre service de traitement des déchets ou le point de vente où vous avez acheté les produits.

### **[Pour les professionnels dans l'Union Européenne]**

Si vous souhaitez vous débarrasser des déchets d'équipements électriques et électroniques veuillez contacter votre vendeur ou fournisseur pour plus d'informations.

### **[Information sur le traitement dans d'autres pays en dehors de l'Union Européenne]**

Ce symbole est seulement valable dans l'Union Européenne. Si vous souhaitez vous débarrasser de déchets d'équipements électriques et électroniques, veuillez contacter les autorités locales ou votre fournisseur et demander la méthode de traitement appropriée.

## Información para Usuarios sobre Recolección y Disposición de Equipamiento Viejo



Este símbolo en los productos, embalaje, y/o documentación que se acompaña significa que los productos electrónicos y eléctricos usados no deben ser mezclados con desechos hogareños corrientes.

Para el tratamiento, recuperación y reciclado apropiado de los productos viejos, por favor llévelos a puntos de recolección aplicables, de acuerdo a su legislación nacional y las directivas 2002/96/EC.

Al disponer de estos productos correctamente, ayudará a ahorrar recursos valiosos y a prevenir cualquier potencial efecto negativo sobre la salud humana y el medio ambiente, el cual podría surgir de un inapropiado manejo de los desechos.

Para mayor información sobre recolección y reciclado de productos viejos, por favor contacte a su municipio local, su servicio de gestión de residuos o el punto de venta en el cual usted adquirió los artículos.

### **[Para usuarios de negocios en la Unión Europea]**

Si usted desea deshacerse de equipamiento eléctrico y electrónico, por favor contacte a su vendedor o proveedor para mayor información.

### **[Información sobre la Disposición en otros países fuera de la Unión Europea]**

Este símbolo sólo es válido en la Unión Europea. Si desea deshacerse de estos artículos, por favor contacte a sus autoridades locales y pregunte por el método correcto de disposición.

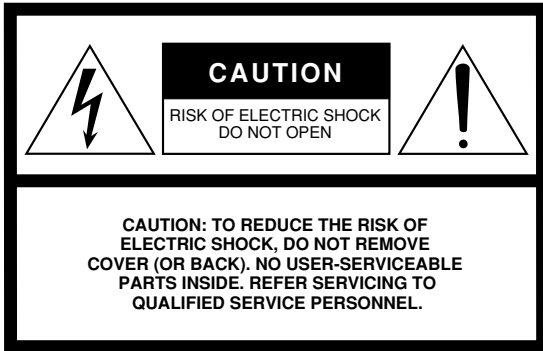

The above warning is located on the bottom of the unit.

## Explanation of Graphical Symbols

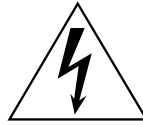

The lightning flash with arrowhead symbol within an equilateral triangle is intended to alert the user to the presence of uninsulated “dangerous voltage” within the product’s enclosure that may be of sufficient magnitude to constitute a risk of electric shock to persons.



The exclamation point within an equilateral triangle is intended to alert the user to the presence of important operating and maintenance (servicing) instructions in the literature accompanying the product.

# IMPORTANT SAFETY INSTRUCTIONS

- 1 Read these instructions.
- 2 Keep these instructions.
- 3 Heed all warnings.
- 4 Follow all instructions.
- 5 Do not use this apparatus near water.
- 6 Clean only with dry cloth.
- 7 Do not block any ventilation openings. Install in accordance with the manufacturer’s instructions.
- 8 Do not install near any heat sources such as radiators, heat registers, stoves, or other apparatus (including amplifiers) that produce heat.
- 9 Do not defeat the safety purpose of the polarized or grounding-type plug. A polarized plug has two blades with one wider than the other. A grounding type plug has two blades and a third grounding prong. The wide blade or the third prong are provided for your safety. If the provided plug does not fit into your outlet, consult an electrician for replacement of the obsolete outlet.
- 10 Protect the power cord from being walked on or pinched particularly at plugs, convenience receptacles, and the point where they exit from the apparatus.
- 11 Only use attachments/accessories specified by the manufacturer.
- 12 Use only with the cart, stand, tripod, bracket, or table specified by the manufacturer, or sold with the apparatus. When a cart is used, use caution when moving the cart/apparatus combination to avoid injury from tip-over.
- 13 Unplug this apparatus during lightning storms or when unused for long periods of time.
- 14 Refer all servicing to qualified service personnel. Servicing is required when the apparatus has been damaged in any way, such as power-supply cord or plug is damaged, liquid has been spilled or objects have fallen into the apparatus, the apparatus has been exposed to rain or moisture, does not operate normally, or has been dropped.



### WARNING

TO REDUCE THE RISK OF FIRE OR ELECTRIC SHOCK, DO NOT EXPOSE THIS APPARATUS TO RAIN OR MOISTURE.

(UL60065\_03)

For details of products, please contact your nearest Yamaha representative or the authorized distributor listed below.

Pour plus de détails sur les produits, veuillez-vous adresser à Yamaha ou au distributeur le plus proche de vous figurant dans la liste suivante.

Die Einzelheiten zu Produkten sind bei Ihrer unten aufgeführten Niederlassung und bei Yamaha Vertragshändlern in den jeweiligen Bestimmungsländern erhältlich.

Para detalles sobre productos, contacte su tienda Yamaha más cercana o el distribuidor autorizado que se lista debajo.

## NORTH AMERICA

### CANADA

**Yamaha Canada Music Ltd.**  
135 Milner Avenue, Scarborough, Ontario,  
M1S 3R1, Canada  
Tel: 416-298-1311

### U.S.A.

**Yamaha Corporation of America**  
6600 Orangethorpe Ave., Buena Park, Calif. 90620,  
U.S.A.  
Tel: 714-522-9011

## CENTRAL & SOUTH AMERICA

### MEXICO

**Yamaha de México S.A. de C.V.**  
Calz. Javier Rojo Gómez #1149,  
Col. Guadalupe del Moral  
C.P. 09300, México, D.F., México  
Tel: 55-5804-0600

### BRAZIL

**Yamaha Musical do Brasil Ltda.**  
Rua Joaquim Floriano, 913 - 4º andar, Itaim Bibi,  
CEP 04534-013 Sao Paulo, SP. BRAZIL  
Tel: 011-3704-1377

### ARGENTINA

**Yamaha Music Latin America, S.A.**  
**Sucursal de Argentina**  
Olga Cossetini 1553, Piso 4 Norte  
Madero Este-C1107CEK  
Buenos Aires, Argentina  
Tel: 011-4119-7000

### PANAMA AND OTHER LATIN AMERICAN COUNTRIES/ CARIBBEAN COUNTRIES

**Yamaha Music Latin America, S.A.**  
Torre Banco General, Piso 7, Urbanización Marbella,  
Calle 47 y Aquilino de la Guardia,  
Ciudad de Panamá, Panamá  
Tel: +507-269-5311

## EUROPE

### THE UNITED KINGDOM/IRELAND

**Yamaha Music U.K. Ltd.**  
Sherbourne Drive, Tilbrook, Milton Keynes,  
MK7 8BL, England  
Tel: 01908-366700

### GERMANY

**Yamaha Music Europe GmbH**  
Siemensstraße 22-34, 25462 Rellingen, Germany  
Tel: 04101-3030

### SWITZERLAND/LIECHTENSTEIN

**Yamaha Music Europe GmbH**  
**Branch Switzerland in Zürich**  
Seefeldstrasse 94, 8008 Zürich, Switzerland  
Tel: 01-383 3990

### AUSTRIA

**Yamaha Music Europe GmbH Branch Austria**  
Schleiergasse 20, A-1100 Wien, Austria  
Tel: 01-60203900

### CZECH REPUBLIC/SLOVAKIA/ HUNGARY/SLOVENIA

**Yamaha Music Europe GmbH Branch Austria**  
Schleiergasse 20, A-1100 Wien, Austria  
Tel: 01-602039025

### POLAND/LITHUANIA/LATVIA/ESTONIA

**Yamaha Music Europe GmbH**  
**Branch Sp. z o.o. Oddział w Polsce**  
ul. 17 Stycznia 56, PL-02-146 Warszawa, Poland  
Tel: 022-868-07-57

### THE NETHERLANDS/ BELGIUM/LUXEMBOURG

**Yamaha Music Europe Branch Benelux**  
Clarissenhof 5-b, 4133 AB Vianen, The Netherlands  
Tel: 0347-358 040

### FRANCE

**Yamaha Musique France**  
BP 70-77312 Marne-la-Vallée Cedex 2, France  
Tel: 01-64-61-4000

### ITALY

**Yamaha Musica Italia S.P.A.**  
Viale Italia 88, 20020 Lainate (Milano), Italy  
Tel: 02-935-7771

### SPAIN/PORTUGAL

**Yamaha Música Ibérica, S.A.**  
Ctra. de la Corona km. 17, 200, 28230  
Las Rozas (Madrid), Spain  
Tel: 91-639-8888

### GREECE

**Philippos Nakas S.A. The Music House**  
147 Skiathou Street, 112-55 Athens, Greece  
Tel: 01-228 2160

### SWEDEN

**Yamaha Scandinavia AB**  
J. A. Wettergrens Gata 1, Box 30053  
S-400 43 Göteborg, Sweden  
Tel: 031 89 34 00

### DENMARK

**YS Copenhagen Liaison Office**  
Generatorvej 6A, DK-2730 Herlev, Denmark  
Tel: 44 92 49 00

### FINLAND

**F-Musiikki Oy**  
Kluuvikatu 6, P.O. Box 260,  
SF-00101 Helsinki, Finland  
Tel: 09 618511

### NORWAY

**Norsk filial av Yamaha Scandinavia AB**  
Grini Næringspark 1, N-1345 Østerås, Norway  
Tel: 67 16 77 70

### ICELAND

**Skifan HF**  
Skeifan 17 P.O. Box 8120, IS-128 Reykjavik, Iceland  
Tel: 525 5000

### RUSSIA

**Yamaha Music (Russia)**  
Office 4015, entrance 2, 21/5 Kuznetskii  
Most street, Moscow, 107996, Russia  
Tel: 495 626 0660

### OTHER EUROPEAN COUNTRIES

**Yamaha Music Europe GmbH**  
Siemensstraße 22-34, 25462 Rellingen, Germany  
Tel: +49-4101-3030

## AFRICA

**Yamaha Corporation,**  
**Asia-Pacific Music Marketing Group**  
Nakazawa-cho 10-1, Naka-ku, Hamamatsu,  
Japan 430-8650  
Tel: +81-53-460-2312

## MIDDLE EAST

### TURKEY/CYPRUS

**Yamaha Music Europe GmbH**  
Siemensstraße 22-34, 25462 Rellingen, Germany  
Tel: 04101-3030

### OTHER COUNTRIES

**Yamaha Music Gulf FZE**  
LOB 16-513, P.O.Box 17328, Jubel Ali,  
Dubai, United Arab Emirates  
Tel: +971-4-881-5868

## ASIA

### THE PEOPLE'S REPUBLIC OF CHINA

**Yamaha Music & Electronics (China) Co., Ltd.**  
2F, Yunhedasha, 1818 Xinzha-lu, Jingan-qu,  
Shanghai, China  
Tel: 021-6247-2211

### HONG KONG

**Tom Lee Music Co., Ltd.**  
11/F, Silvercord Tower 1, 30 Canton Road,  
Tsimshatsui, Kowloon, Hong Kong  
Tel: 2737-7688

### INDIA

**Yamaha Music India Pvt. Ltd.**  
5F Ambience Corporate Tower Ambience Mall Complex  
Ambience Island, NH-8, Gurgaon-122001, Haryana, India  
Tel: 0124-466-5551

### INDONESIA

**PT. Yamaha Music Indonesia (Distributor)**  
**PT. Nusantik**  
Gedung Yamaha Music Center, Jalan Jend. Gatot  
Subroto Kav. 4, Jakarta 12930, Indonesia  
Tel: 21-520-2577

### KOREA

**Yamaha Music Korea Ltd.**  
8F, 9F, Dongsung Bldg. 158-9 Samsung-Dong,  
Kangnam-Gu, Seoul, Korea  
Tel: 080-004-0022

### MALAYSIA

**Yamaha Music Malaysia, Sdn., Bhd.**  
Lot 8, Jalan Perbandaran, 47301 Kelana Jaya,  
Petaling Jaya, Selangor, Malaysia  
Tel: 3-78030900

### PHILIPPINES

**Yupangco Music Corporation**  
339 Gil J. Puyat Avenue, P.O. Box 885 MCPO,  
Makati, Metro Manila, Philippines  
Tel: 819-7551

### SINGAPORE

**Yamaha Music Asia Pte., Ltd.**  
#03-11 A-Z Building  
140 Paya Lebor Road, Singapore 409015  
Tel: 747-4374

### TAIWAN

**Yamaha KHS Music Co., Ltd.**  
3F, #6, Sec.2, Nan Jing E. Rd. Taipei.  
Taiwan 104, R.O.C.  
Tel: 02-2511-8688

### THAILAND

**Siam Music Yamaha Co., Ltd.**  
4, 6, 15 and 16<sup>th</sup> floor, Siam Motors Building,  
891/1 Rama 1 Road, Wangmai,  
Pathumwan, Bangkok 10330, Thailand  
Tel: 02-215-2626

### OTHER ASIAN COUNTRIES

**Yamaha Corporation,**  
**Asia-Pacific Music Marketing Group**  
Nakazawa-cho 10-1, Naka-ku, Hamamatsu,  
Japan 430-8650  
Tel: +81-53-460-2317

## OCEANIA

### AUSTRALIA

**Yamaha Music Australia Pty. Ltd.**  
Level 1, 99 Queensbridge Street, Southbank,  
Victoria 3006, Australia  
Tel: 3-9693-5111

### NEW ZEALAND

**Music Works LTD**  
P.O. BOX 6246 Wellesley, Auckland 4680,  
New Zealand  
Tel: 9-634-0099

### COUNTRIES AND TRUST

### TERRITORIES IN PACIFIC OCEAN

**Yamaha Corporation,**  
**Asia-Pacific Music Marketing Group**  
Nakazawa-cho 10-1, Naka-ku, Hamamatsu,  
Japan 430-8650  
Tel: +81-53-460-2312

**HEAD OFFICE** Yamaha Corporation, Pro Audio & Digital Musical Instrument Division  
Nakazawa-cho 10-1, Naka-ku, Hamamatsu, Japan 430-8650  
Tel: +81-53-460-3273





Yamaha Home Keyboards Home Page  
<http://music.yamaha.com/homekeyboard/>  
Yamaha Manual Library  
<http://www.yamaha.co.jp/manual/>

U.R.G., Pro Audio & Digital Musical Instrument Division, Yamaha Corporation  
© 2009 Yamaha Corporation

WR86780 XXXPOXXX.X-01A0  
Printed in Indonesia